

12 GRADI

Piatto doccia asimmetrico in AROCK®
AROCK® asymmetric shower tray

Receveur de douche asymétrique en AROCK®
Asymmetrische Duschwanne aus AROCK®



CARATTERISTICHE FEATURES CARACTÉRISTIQUES EIGENSCHAFTEN



SPESORE 3 cm
3 cm THICK
ÉPAISSEUR 3 cm
HÖHE 3 cm

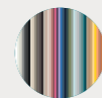

48 COLORI DI CUI 3 STANDARD
48 COLOURS - 3 STANDARD COLOURS
48 COULEURS DONT 3 STANDARDS
48 FARBEN - 3 STANDARDFARBEN



NON REVERSIBILE
NON-REVERSIBLE
NON-RÉVERSIBLE
NICHT UMKEHRBAR



MISURA 120 x 80 cm
SIZE 120 x 80 cm
DIMENSION 120 x 80 cm
MAß 120 X 80 cm



SX / LH / GA / LINKS DX / RH / DR / RECHTS

INFO TECNICHE TECHNICAL INFORMATION INFOS TECHNIQUES TECHNISCHE HINWEISE



PRODOTTO IN AROCK®
AROCK® PRODUCT
PRODUIT EN AROCK®
PRODUKT AUS AROCK®



ANTISCIVOLO
ANTI-SLIP SURFACE
ANTIDÉRAPANT
RUTSCHFESTE OBERFLÄCHE



INSTALLAZIONE SOPRA PAVIMENTO
OVER FLOOR INSTALLATION
MONTAGE À POSER
INSTALLATION AUF DEM BODEN



INSTALLAZIONE FILO PAVIMENTO
LEVEL ACCESS
MONTAGE À ENCASTRER
BODENBÜNDIGE INSTALLATION



NON PERSONALIZZABILE
NO CUSTOMIZATIONS
PAS PERSONNALISÉ
SONDERMAß NICHT ERHÄLTICH

Colori e finiture | Colours and finishes | Couleurs et finitions | Farben und Ausführungen

Piatto doccia | Shower tray | Receveur de douche | Duschwanne

STD - STANDARD OPT - OPTIONAL

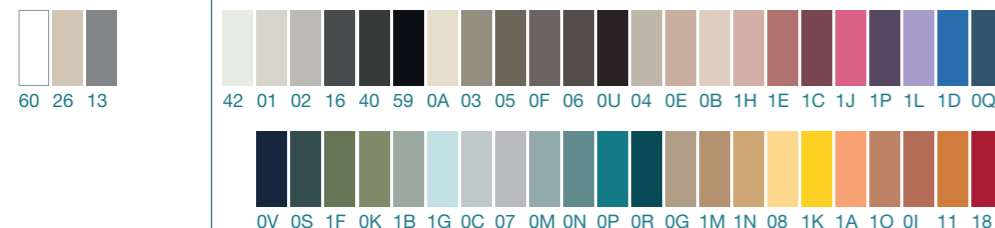

Copripiletta | Drain cover | Couvre-bonde | Ablaufabdeckung



INCLUSO: nello stesso colore del piatto doccia
INCLUDED: the same color as the shower tray
INCLUS: dans la même couleur du receveur
INBEGRIFFEN: der gleichen Farbe wie die Duschwanne

OPTIONAL: altra finitura (da ordinare separatamente)
OPTIONAL: further available finishes (purchased separately)
OPTIONAL: couleurs en option (à commander séparément)
OPTIONAL: zusätzliche ausführungen (getrennt zu erwerben)

I colori e le finiture qui riportati sono da considerarsi indicativi
The colours and the finishing are to be considered indicative
Les couleurs et les finitions sont à considérer comme indicatives
Die Farben und Fertigungen sind als Richtwerte zu betrachten

DG-NO

Installazione ad angolo
Corner installation

Installation en angle
Eckige Installation

Senza bordi | Without rims | Sans bords | Ohne Ränder

Codice SX RH Code Code GA Code Links	Codice DX LH Code Code DR Code Rechts	Misure cm Sizes cm Mesures cm Maße cm	STD	OPT
DGN080121	DGN080120	80 x 120	520	520

Installazioni | Installations | Installations | Lösungen

SX / LH / GA / LINKS
DG-NO

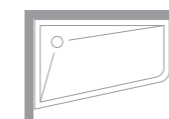

DX / RH / DR / RECHTS
DG-NO

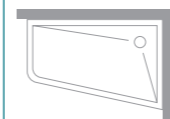

Informazioni | Informations | Informations | Informationen

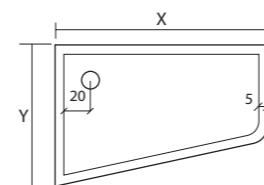

X	Y	h
120	80	39

Y larghezza \ width \ largeur \ Breite
X lunghezza \ length \ longueur \ Länge

Attenzione | Warning | Attention | Achtung

Il copripiletta è incluso
nello stesso colore del
piatto doccia

La couvre bonde est incluse
dans la même finition du
receveur

La piletta di scarico mod.
GBRT è inclusa nel piatto
doccia

La bonde de vidage mod.
GBRT est inclus

Il piatto doccia non può
essere personalizzato con
tagli a misura

Le receveur de douche ne
peut pas être personnalisé
avec des coupes sur mesure

The drain cover is included
with the same colour as the
shower tray

Die Ablaufabdeckung der
gleichen Farbe wie die Du-
schwanne ist inbegriffen

The drain collector mod. GBRT
is included

Der Ablaufbehälter mod. GBRT
ist inbegriffen

Size and shape customisations
are not available

Sondermaße und Sondersch-
nitte sind nicht erhältlich

Supplementi | Supplements | Suppléments | Ergänzungen

Copripiletta OPTIONAL
Drain cover OPTIONAL
Couvre bonde EN OPTION
Ablaufabdeckung OPTIONAL

Sigillante SPARTAN®
Sealant SPARTAN®
Mastic SPARTAN®
SPARTAN®-klebedichtstoff

TCB - Kit rimozione calcare
TCB - Limescale remover KIT
TCB - Kit de détartrage
TCB - Kalkentfernungskit

Informazioni tecniche | Technical informations
Informations techniques | Technische Informationen 42

Ricambi e Accessori | Spare parts and Accessories
Pièces détachées et Accessoires | Ersatzteile und Zubehör 43

AZCOP12GC € 69

36B010010 € 27

36A010010 € 54

STD
colori standard / standard colours
couleurs standard / Standardfarben

OPT
colori opzionali / optional colours
couleurs en option / Optionalfarben

MODELLO ASIMMETRICO | ASYMMETRIC MODEL | MODÈLE ASYMÉTRIQUE | ASYMMETRISCHES MODEL

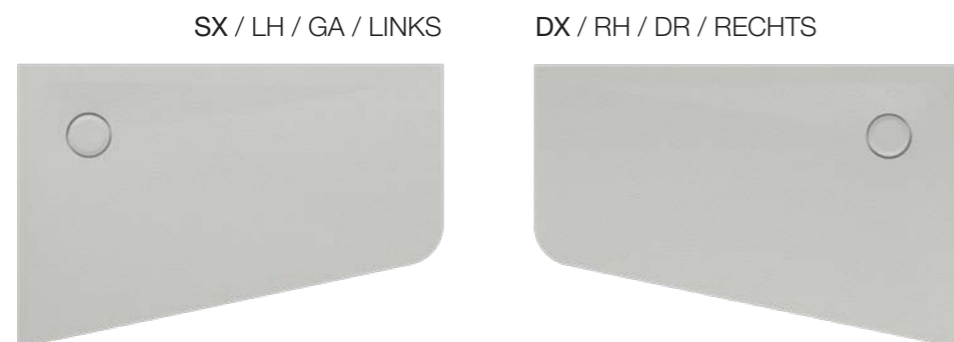

Sp. 3 cm - senza bordi | thick 3 cm - without rims | ep. 3 cm - sans bords | Höhe 3 cm - ohne Ränder

ATTENZIONE | WARNING | ATTENTION | ACHTUNG

Il piatto doccia 12GRADI non può essere personalizzato con tagli a misura
The shower tray 12GRADI is not available as a bespoke item in size and shape
Le receveur de douche 12GRADI ne peut pas être personnalisé avec des découpes s-mesure
Die Duschwanne 12GRADI ist in Sondermaß nicht erhältlich

Quote tecniche | Technical quotes | Mesures techniques | Technische Details

PIATTO DOCCIA | Shower tray | Receveur de douche | Duschwanne

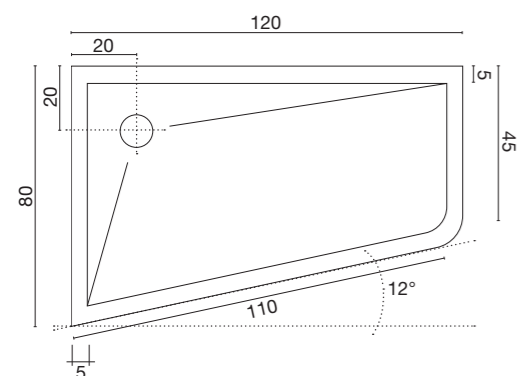

COPRIPILETTA | Drain cover | Couvre-bonde | Ablaufabdeckung

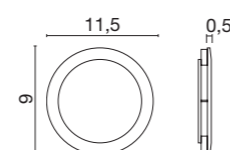

L'immagine sopra è SX, la DX è speculare
The image above is LH, the RH is mirrored
L'image ci-dessus est GA, le DR est en miroir
Das Bild oben ist Version links, die Version rechts ist gespiegelt

Installazioni | Installations | Installations | Lösungen



INSTALLAZIONE SOPRA PAVIMENTO
OVER FLOOR INSTALLATION
MONTAGE À POSER
INSTALLATION AUF DEM BODEN

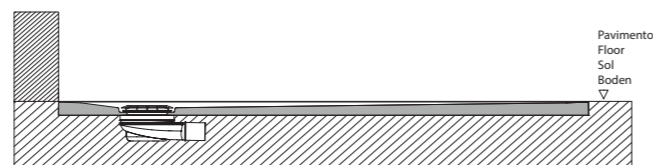

INSTALLAZIONE FILO PAVIMENTO
LEVEL ACCESS
MONTAGE À ENCASTRER
BODENBÜNDIGE INSTALLATION

ATTENZIONE | WARNING | ATTENTION | ACHTUNG

Il piatto doccia 12GRADI ha una tolleranza di +/- 5 mm su tutte le dimensioni
All dimensions of the shower tray 12GRADI are toleranced +/- 5 mm
Le receveur de douche 12GRADI a une tolérance de +/- 5 mm sur toutes les dimensions
Alle Maße der Duschwanne 12GRADI haben eine Herstellungstoleranz von +/- 5 mm

Piletta di scarico | Drain collector | Bonde de vidage | Ablaufbehälter

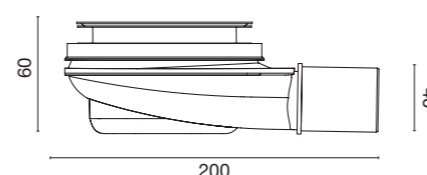

INCLUSA: modello GBRT H 6 cm
INCLUDED: model GBRT H 6 cm
INCLUSE: modèle GBRT H 6 cm
INBEGRIFFEN: Modell GBRT H 6 cm

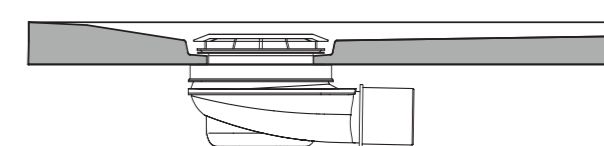

Sezione del piatto doccia 12GRADI con piletta
Sectional drawing 12GRADI with drain collector
Section d'un receveur de douche 12GRADI avec bonde de vidage
Schnittzeichnung 12GRADI mit Ablaufbehälter

Area soffione | Shallow waste | Zone pomme de douche | Bereich der Duschbrause

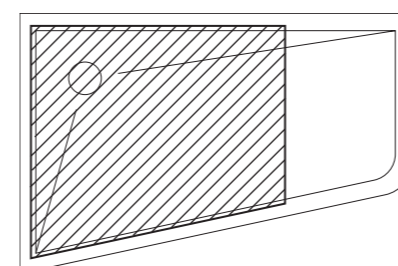

Area di maggior deflusso consigliata per l'installazione di un soffione doccia
Max water outflow area-recommended for the installation of the shower head
Zone d'écoulement majeur conseillé pour l'installation de la colonne de douche
Maximaler Wasserauslaufbereich - empfohlen für die Installation der Duschkopfes

Ricambi e Accessori | Spare parts and Accessories | Pièces détachées et Accessoires | Ersatzteile und Zubehör

	Piletta di scarico GBRT Ø 9 - H 6 cm Drain collector GBRT Ø 9 - H 6 cm Bonde de vidage GBRT Ø 9 - H 6 cm Ablaufbehälter GBRT Ø 9 - H 6 cm	Cod.	Nr pezzi Nr pièces Nr pièces Nr. Stücke	€
		AZPD90H61	1	44
	Copripiletta OPTIONAL Drain cover OPTIONAL Couvre-bonde OPTIONAL Ablaufabdeckung OPTIONAL	Cod.	Nr pezzi Nr pièces Nr pièces Nr. Stücke	€
		AZCOP12GC	1	69
	Kit di ritocco per prodotti AROCK® Retouching kit for AROCK® products Kit de retouche AROCK® Retuschierset für Produkte aus AROCK®	Cod.	Nr pezzi Nr pièces Nr pièces Nr. Stücke	€
		AZKRITOC	1	30
	Sigillante SPARTAN® Sealant SPARTAN® Mastic SPARTAN® SPARTAN®-klebedichtstoff	Cod.	Nr pezzi Nr pièces Nr pièces Nr. Stücke	€
		36B010010	1	27
	TCB Taking Care of Bath Kit di rimozione del calcare per superfici in vetro e AROCK® Limescale remover KIT for glass and AROCK® surfaces Kit de détartrage pour surfaces en verre et en AROCK® Kalkentfernungskit für AROCK®-und Glasoberflächen	Cod.	Nr pezzi Nr pièces Nr pièces Nr. Stücke	€
		36A010010	1	54