

**A** piano / top / plan / Platte

## TIPOLOGIE:

filopiano lavabo integrato;  
per lavabo sopra piano da appoggio e  
da incasso e sottopiano da incasso  
PROFONDITA': 45-51,5 cm  
FINITURE: Arock® - HPL - Nobilitato  
LEGNO/ALTATTO - Laccato OPACO/  
LUCIDO - GRES - PIETRA NATURALE -  
SILESTONE - CRISTALLO

## TYPES:

integrated plan washbasin;  
for countertop basin, recessed basin  
and undermounted basin  
DEPTH: 45-51.5 cm  
FINISHES: Arock® - HPL - Nobilitato  
LEGNO/ALTATTO - Laquered MATT/  
GLOSSY - GRES - NATURAL STONE -  
SILESTONE

## TYPOLOGIES:

lavabo intégré au plan;  
pour lavabo à poser, lavabo encastré  
surélevé et lavabo encastré  
PROFONDEUR: 45-51,5 cm  
FINITIONS: Arock® - HPL - Mé laminé  
BOIS/ALTATTO - Laque MAT/BRIL-  
LANT - GRES - PIERRE NATURELLE  
- SILESTONE

## TYPOLOGIEN:

integriertes Waschbecken;  
für Aufsatzwaschtisch, Halbeinbau-  
becken und Einbauwaschtisch  
TIEFE: 45-51,5 cm  
AUSFÜHRUNGEN: Arock® - HPL -  
Melamin HOLZ ALTATTO - MATT/  
HOCHGLANZ Lack - GRES - NATUR-  
STEIN - SILESTONE

**B** contenitore / interior configuration / configuration intérieure / Innenausstattung

realizzato in pannelli di particelle di  
legno di spessore 18 mm, idrofughi,  
nobilitato con carta melaminica colo-  
re URBAN. Bordi in ABS in tinta.  
Cassetto montato su guide GRASS®  
ad estrazione totale con sponde  
laterali in metallo verniciato colore  
URBAN. Fondo e schienale nella  
finitura del contenitore  
zoccolo H 12 cm in PVC  
ALTEZZA : 25-40-50-75 cm  
PROFONDITA': 45-51,5 cm  
LARGHEZZA: 30-35-45-60-70-  
80-90-105-120 cm

made of water repellent panels of 18  
mm thick wood particles, covered  
with Nobilitato URBAN color.  
Matching ABS edges  
Drawer mounted on full extension  
GRASS® runners with URBAN color  
painted metal sides. Bottom and back  
in the finish of the container  
Toe-kick H 12 cm in PVC  
HEIGHT: 25-40-50-75 cm  
DEPTH: 45-51,5 cm  
WIDTH: 30-35-45-60-70-90-105-  
120 cm

en panneaux hydrofuges en particu-  
les de bois de 18 mm d'épaisseur.  
Recouvert de papier mélaminé  
couleur URBAN. Bords ABS de la  
même couleur  
Tiroir monté sur coulisses GRASS®  
pleine extension avec côtés en métal  
peint couleur URBAN. Fond et retour  
dans la finition du intérieur  
Socle H 12 cm en PVC  
HAUTEUR: 25-40-50-75 cm  
PROFONDEUR: 45-51,5 cm  
LARGEUR: 30-35-45-60-70-90-105-  
120 cm

in wasserabweisenden Platten aus  
18 mm starken Holzpartikeln. Farb-  
melaminpapier und ABS Kanten der  
gleichen Farbe  
Schublade montiert auf GRASS®  
Vollauszügen mit URBAN-farbig  
lackierten Metallseiten. Boden und  
Rückseite im Abgang des Behälters  
Sockel H 12 cm aus PVC  
HÖHE: 25-40-50-75 cm  
TIEFE: 45-51,5 cm  
BREITE: 30-35-45-60-70-90-105-  
120 cm

**C** frontali / front panels / tiroirs / Schublade

realizzato in pannelli di particelle di  
legno idrofugo nobilitato con carta  
melaminica  
SPESSORE: 1,8 cm  
FINITURE: Laccato OPACO/LUCIDO 48  
colori.02 - Nobilitato LEGNO

made of water repellent panels of  
wood particles  
THICKNESS: 1,8 cm  
FINISHES: MATT/GLOSSY Lacquered  
48 colori.02 - Nobilitato LEGNO

en panneaux hydrofuges en particules  
de bois recouvert de papier mélaminé  
ÉPAISSEUR: 1,8 cm  
FINITIONS: Laqué MAT/BRILLANT en  
48 colori.02 - Nobilitato LEGNO

aus wasserabweisenden Spanplatten,  
veredelt mit Melaminpapier  
DICKE: 1,8 cm  
OBERFLÄCHEN: MATT/HOCHGLANZ  
Lack aus 48 colori.02 - Nobilitato  
LEGNO

**D** apertura / opening system / système d'ouverture / Öffnungssystem

Maniglia FILO / Maniglia PONTE /  
Smusso 45° / Sistema Premi-Aprì

FILO Handle / PONTE Handle /  
Smusso 45° / Premi-Aprì System

Poignée FILO / Poignée PONTE /  
Smusso 45° / Système Premi-Aprì

FILO Griff / PONTE Griff /  
Smusso 45° / Premi-Aprì System

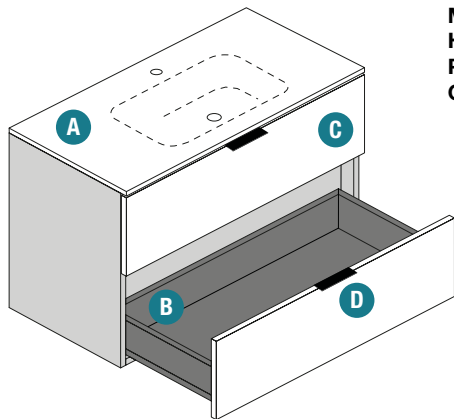

**Maniglia FILO - L 20 cm**  
**Handle FILO**  
**Poignée FILO**  
**Griffe FILO**

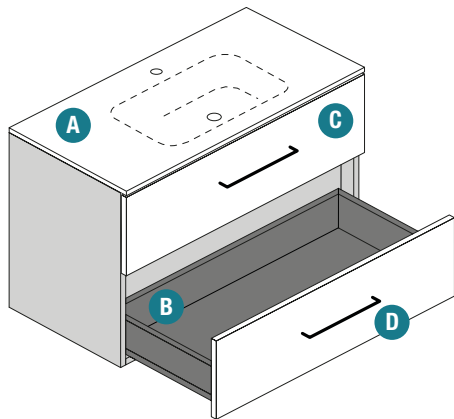

**Maniglia PONTE - L 20,5 / 33 cm**  
**Handle PONTE**  
**Poignée PONTE**  
**Griffe PONTE**

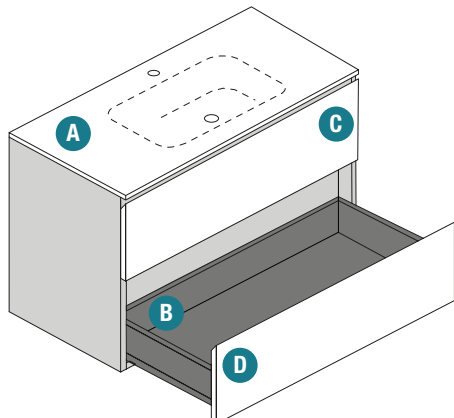

**Smusso 45°**

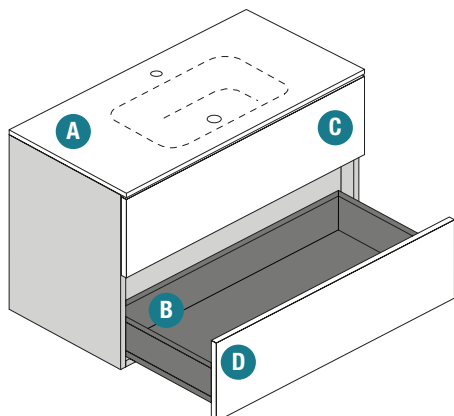

**Sistema Premi-Apri**  
**Premi-Apri System**  
**Système Premi-Apri**  
**Premi-Apri System**



**Nobilitato LEGNO**

pannello di particelle di legno spessore 18 mm idrofugo a basso contenuto di formaldeide nobilitato interno ed esterno con carta melaminica in finitura LEGNO riprodotto ad alta fedeltà; bordo in ABS in finitura

high pressure layered laminate, a perfect and strong imitation of the natural wooden surface

stratifiés décoratifs haute pression. Plaques à base de résines thermoscurissables appelées stratifiés

Hochdruckmehrschichtlaminat mit einer dreidimensionalen Erscheinung

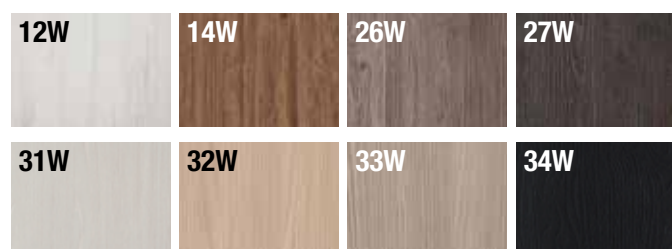
**laccato OPACO / LUCIDO  
MATT / GLOSSY lacquered**

pannello di particelle di legno, idrofugo, a basso contenuto di formaldeide, verniciato con resine poliuretatiche pigmentate opache o lucide

wood particles panel 18 mm with low formaldehyde content, painted with polyurethane resins

**laqué MAT / BRILLANT  
MATT / HOCHGLANZ lackiert**

panneaux de particules de bois 18 mm à faible teneur en formaldéhyde, peint avec des résines de polyuréthane

Holzpartikelplatte 18 mm mit niedrigem Formaldehydgehalt, mit Polyurethanharzen lackiert



i colori qui riportati sono da considerarsi indicativi  
the colours can diverge from the reality  
la fidélité des couleurs peut être différent de la réalité  
bitte berücksichtigen Sie unsere Farbfächer zur Farbauswahl



**Maniglia PONTE - L 20 cm**

**FINITURE:**

. laccato OPACO 48 colori.02  
. extra pag. 592

**PONTE Handle - L 20 cm**

**FINISHES:**

. MATT lacquered 48 colori.02  
. extra pag. 592

**Poignée PONTE - L 20 cm**

**FINITIONS:**

. laqué MAT 48 colori.02  
. extra pag. 592

**PONTE Griff - L 20 cm**

**OBERFLÄCHEN:**

. MATT lackiert 48 colori.02  
. extra pag. 592



CROMO OPACO



TITANIO



ORO OPACO SATINATO



**Maniglia FILO - L 20 cm**

**FINITURE:**

. laccato OPACO 48 colori.02

**FILO Handle - L 20 cm**

**FINISHES:**

. MATT lacquered 48 colori.02

**Poignée FILO - L 20 cm**

**FINITIONS:**

. laqué MAT 48 colori.02

**FILO Griff - L 20 cm**

**OBERFLÄCHEN:**

. MATT lackiert 48 colori.02

**abbinamento consigliato mobile/maniglia  
combinations furniture/handle**









**coordinations meuble/poignée  
Griffeabstimmung**

mobile Nobilitato LEGNO

maniglia laccato OPACO

-  **12W** ABETE BIANCO
-  **14W** ABETE BROWN
-  **26W** ABETE ROCCIA
-  **27W** ABETE FONDENTE
-  **31W** FRONDA PURO
-  **32W** FRONDA LIEVE
-  **33W** FRONDA NUDO
-  **34W** FRONDA ARCANO



-  **01** NUDE
-  **0H** CURCUMA
-  **05** WILD
-  **0U** MOCHA
-  **01** NUDE
-  **0G** EARTH
-  **03** NATURE
-  **59** NERO

UNICAMENTE

AROCK®

ALCENTIMETRO

PROGETTO®

piani / tops / plans / \Platten

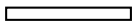

piano e piano d'arredo  
top for interior  
plan pour l'ameublement  
Platte fuer Einrichtung

piano e piano d'arredo accoppiato  
coated  
accouplé  
verdoppelt

lavabo / basin / vasque / Becken

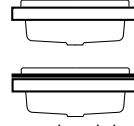
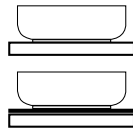

soprapiano da appoggio  
countertop basin  
lavabo à poser  
Aufsetzbecken

soprapiano da incasso  
recessed basin  
lavabo encastré surélevé  
Halbeinbaubecken

sottopiano da incasso  
undermounted basin  
lavabo en profondeur  
Untereinbaubecken

lavabo integrato  
integrated basin  
vasque intégrée  
integriertes Becken

	SP cm	P 45 cm	P 51,5 cm	
<b>AROCK®</b>	1,2 / 6			
<b>Laccato OPACO / LUCIDO</b>	1,8			
<b>Nobilitato LEGNO / ALTATTO</b>	1,8			
<b>Nobilitato LEGNO / ALTATTO + GRES</b> <b>Laccato OPACO / LUCIDO + GRES</b>	2,4			
<b>HPL</b>	1			
<b>GRES</b>	0,6 / 1,2			
	1,2			
<b>CRISTALLO extrachiaro verniciato</b> <b>extra-clear lacquered GLASS</b> <b>VERRE lacquée extraclair</b> <b>Hochglanz lackierte GLAS</b>	1,2			
<b>PIETRA NATURALE</b> <b>NATURAL STONE</b> <b>PIERRE NATURELLE</b> <b>NATURSTEIN</b>	2			
<b>SILESTONE</b>	1,2			

**Modularità**  
**Modularity**

**Modularité**  
**Modularität**

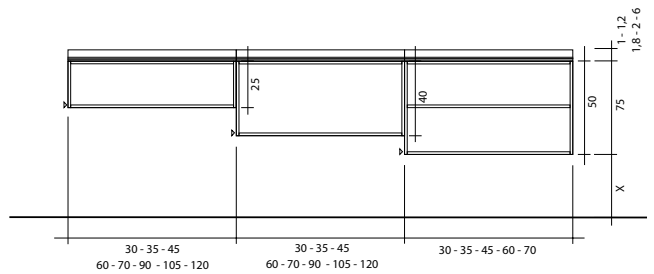
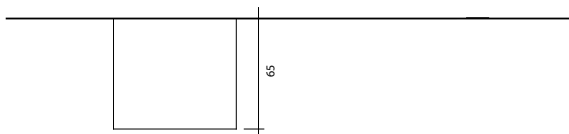
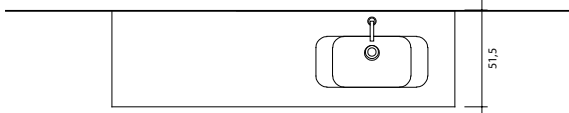
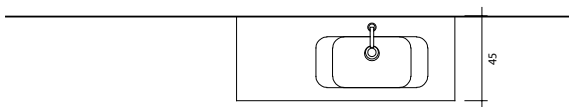
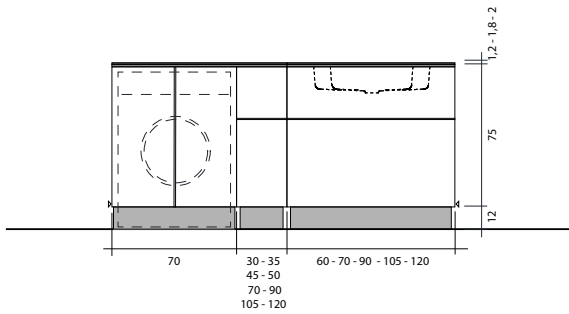
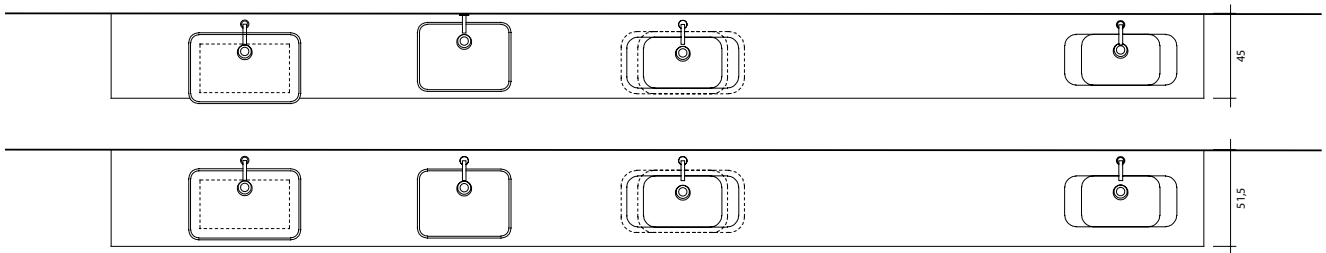
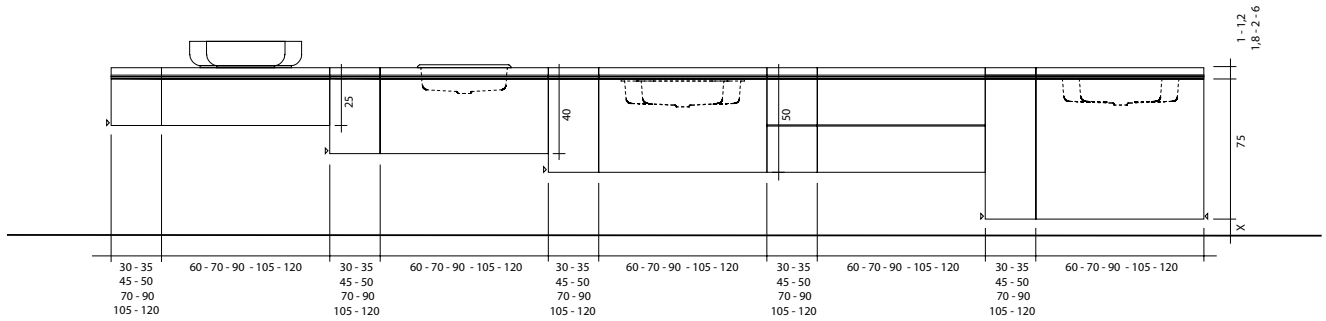

**basi portavaso**  
**vanity units**  
**meubles sous-vasque**  
**Waschtischunterschänke**

L 60-70-90-105-120 cm

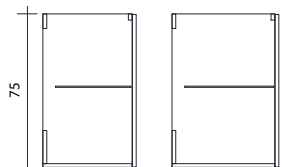
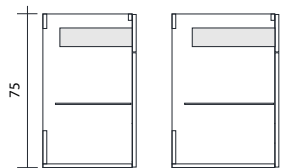
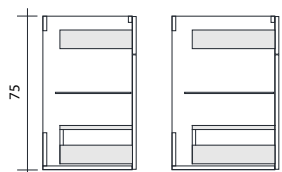
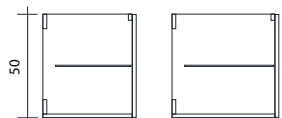
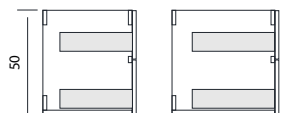
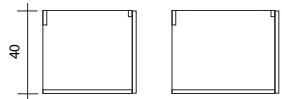
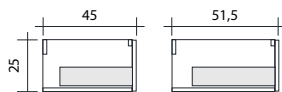

**basi laterali**  
**side units**  
**meubles bas latéraux**  
**Unterschänke**

L 30-35-45-60-70-90-105-120 cm

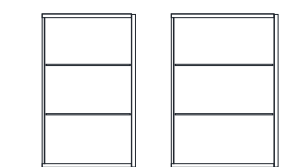
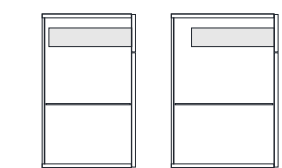
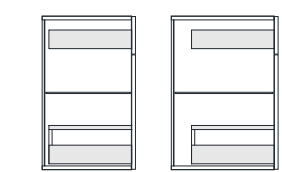
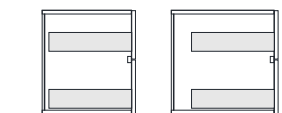
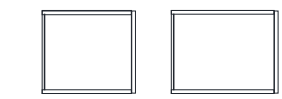
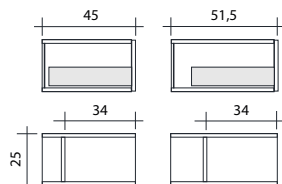

frontale unico estraibile con cassetto, chiusura ammortizzata  
 single pull-out, soft-closing  
 façade amovible avec tiroir  
 1 Schublade

vano a giorno  
 shelving unit  
 éléments ouverts  
 offenen Elementen

frontale unico estraibile con cassetto, chiusura ammortizzata  
 single pull-out, soft-closing  
 façade amovible avec tiroir  
 1 Schublade

1 anta o 2 ante chiusura ammortizzata  
 single door or double door, soft-closing  
 1 porte ou 2 portes  
 1 Tür oder 2 Türen

vano a giorno  
 shelving unit  
 éléments ouverts  
 offenen Elementen

frontale unico estraibile con cassetto chiusura ammortizzata + 1 ripiano  
 single pull-out, soft-closing + 1 shelf  
 façade amovible avec tiroir + 1 étagère  
 1 Schublade + 1 Regal

doppio frontale estraibile con cassetto, chiusura ammortizzata  
 double soft-closing pull-out  
 2 tiroirs amortis  
 2 Schubladen

1 anta o 2 ante chiusura ammortizzata + 1 ripiano  
 single door or double door, soft-closing + 1 shelf  
 1 porte ou 2 portes + 1 étagère  
 1 Tür oder 2 Türen + 1 Regal

vano a giorno  
 shelving unit  
 éléments ouverts  
 offenen Elementen

doppio frontale estraibile con cassetto, chiusura ammortizzata + 1 ripiano  
 double soft-closing pull-out + 1 shelf  
 2 tiroirs amortis + 1 étagère  
 2 Schubladen + 1 Regal

1 anta o 2 ante chiusura ammortizzata + 1 ripiano  
 single door or double door, soft-closing + 1 shelf  
 1 porte ou 2 portes + 1 étagère  
 1 Tür oder 2 Türen + 1 Regal

1 anta o 2 ante chiusura ammortizzata + 1/2 ripiano  
 single door or double door, soft-closing + 1/2 shelf  
 1 porte ou 2 portes + 1/2 étagère  
 1 Tür oder 2 Türen + 1/2 Regal