

RICHIEDENTE
APPLICANT / CLIENT

.....
.....
.....



TIMBRO / CUSTOMER'S SEAL / TAMPON

MODELLO
MODEL / MODELE

ITALO : IT-8

ALTEZZA
HEIGHT / HAUTEUR

..... mm.



REVERSIBILE
REVERSIBLE / REVERSIBLE

SP. VETRO
HEIGHT / HAUTEUR

8 mm

LASTRA
GLASS / VERRE

.....

COLORE
COLOUR / COULEUR

.....

NOTE / NOTES / NOTES

.....
.....
.....

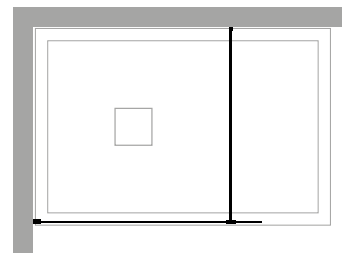

min 300 / max 1800 mm.

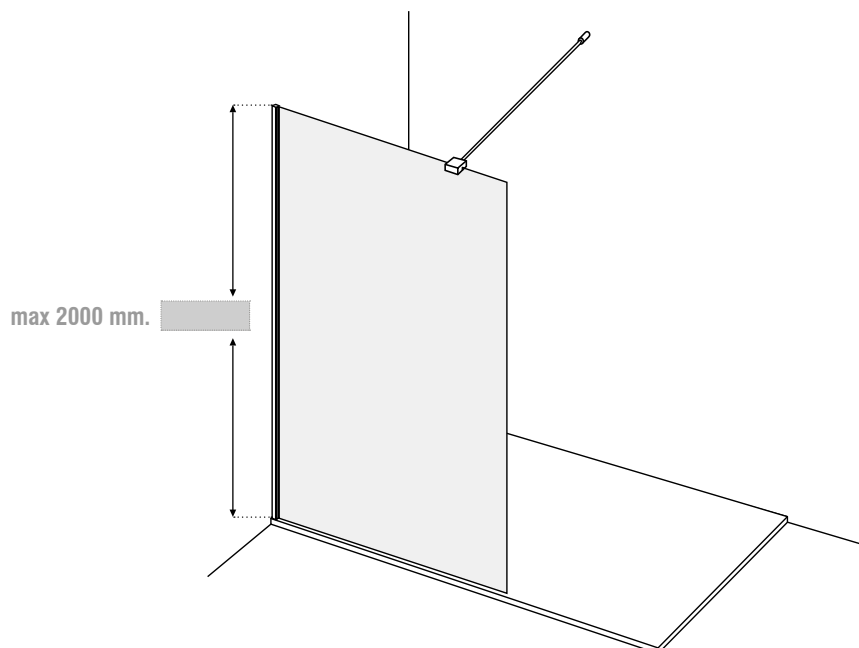

max 2000 mm.