

021 / euro

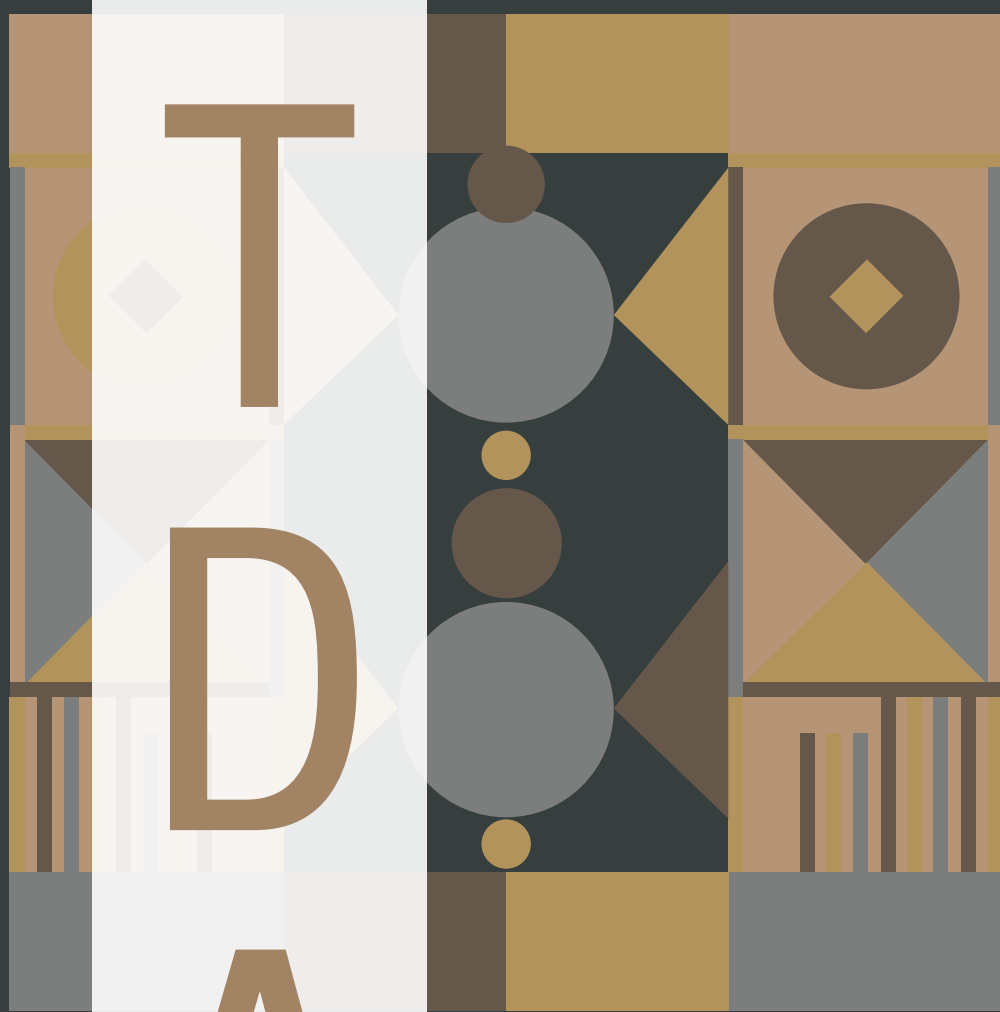

T

D

Arredi

**TDA**  
BATHROOM PRODUCTS OF ITALY

per ordinare aggiungere al codice del prodotto  
 - il numero del colore  
 - e il codice C (Laccato opaco) / N (Laccato lucido) / H (Arock®)

cod		Colori.02
C	Laccato opaco	<b>F1</b>
N	Laccato lucido	<b>F2</b>
H	Arock®	<b>F4</b>

<b>60</b>	<b>42</b>	<b>01</b>
BIANCO	LATTE	NUDE
<b>07</b>	<b>13</b>	<b>0F</b>
FANCY	ELEGANT GREY	ROMAN
<b>0A</b>	<b>26</b>	<b>04</b>
POWDER	AUTUMN BEIGE	COOKIE
<b>02</b>	<b>03</b>	<b>05</b>
ROYAL	NATURE	WILD
<b>0C</b>	<b>0D</b>	<b>0M</b>
SLATE	TITANIUM	VENETIAN
<b>0N</b>	<b>0P</b>	<b>0R</b>
CYPRUS	TURQUOISE	EUCALYPTUS
<b>0S</b>	<b>0K</b>	<b>0L</b>
BAMBOU	PISTACHO	LICHEN
<b>0B</b>	<b>0E</b>	<b>0G</b>
SAND	BISCUIT	EARTH
<b>0H</b>	<b>0J</b>	<b>11</b>
CURCUMA	AMBER	ROCK
<b>0I</b>	<b>0T</b>	<b>18</b>
HAVANA	TERRACOTTA	MASSAI
<b>0Q</b>	<b>0V</b>	<b>06</b>
OCEAN	DENIM	DIVA
<b>0U</b>	<b>16</b>	<b>40</b>
MOCHA	DEEP GREY	URBAN
<b>59</b>	<b>14</b>	<b>12</b>
NERO	CORAL	BALLERINA
<b>08</b>	<b>10</b>	<b>15</b>
PRINCESS	ENJOY	PASSION
<b>85</b>	<b>90</b>	<b>75</b>
LUCKY	LAGOON	LAVANDER
<b>98</b>	<b>0Y</b>	<b>0X</b>
SECRET	SILK	PASTEL

per ordinare aggiungere al codice del prodotto  
 - il numero della finitura

Nobilitati		
Nobilitati legno / altatto <b>F3</b>		
<b>12W</b>	<b>14W</b>	<b>26W</b>
ABETE BIANCO	ABETE BROWN	ABETE ROCCIA
<b>27W</b>	<b>31W</b>	<b>32W</b>
ABETE FONDENTE	FRONDA PURO	FRONDA LIEVE
<b>33W</b>	<b>34W</b>	
FRONDA NUDO	FRONDA ARCANO	<b>01I</b>
		ALTATTO LUNARE
<b>02I</b>	<b>03I</b>	<b>04I</b>
ALTATTO BIOTITE	ALTATTO GENESI	ALTATTO MARKINA

per ordinare aggiungere al codice del prodotto  
 - il numero della finitura

abitat/vogue		
abitat / vogue <b>F5</b>		
<b>21C</b>	<b>22C</b>	<b>27C</b>
Tinox	Tbronz	Tcrom
<b>61C</b>	<b>62C</b>	<b>63C</b>
Orosatinato	Ororosa	Cromonero

per ordinare aggiungere al codice del prodotto  
 - il numero della finitura

HPL		SILESTONE
<b>01P</b>	<b>02P</b>	<b>36P</b>
GREY CARDOSO	CALYPSO	GRIS EXPO OPACO
<b>03P</b>	<b>04P</b>	<b>38P</b>
VOYAGE SILVER	VOYAGE BRONZE	MARENGO
<b>05P</b>	<b>06P</b>	<b>41P</b>
CORTEN GRIGIO	GREY PULPIS	BLANCO ZEUS
<b>07P</b>	<b>08P</b>	
WHITE YULE	MARQUINIA	
<b>09P</b>	<b>10P</b>	
ROVERE VISONE	ROVERE ICELAND	
<b>11P</b>	<b>12P</b>	
OLMO NATURALE	ROVERE SLAVONIA	
<b>13P</b>	<b>14P</b>	
NOCE SAVOIA	CILIEGIO AVOLA	
<b>15P</b>		
WENGE GOLD		

## PIETRA NATURALE

<b>30P</b>	<b>31P</b>
BIANCO CARRARA	PIETRA SERENA
<b>32P</b>	
GRAFITE	
<b>34P</b>	
EMPERADOR	

## CRISTALLO

<b>23P</b>	<b>24P</b>
BIANCO	ROYAL
<b>25P</b>	<b>26P</b>
ROMAN	DEEP GREY
<b>27P</b>	
NERO	

## CASTMARBLE

<b>20P</b>	<b>21P</b>
BIANCO LUCIDO	BIANCO OPACO

## TECNORIL

<b>22P</b>
BIANCO OPACO

## GRES

<b>50P</b>	<b>53P</b>
SPATOLATO SILVER	SPATOLATO PLUMB
<b>56P</b>	<b>59P</b>
SPATOLATO AMBER	SPATOLATO IVORY
<b>54P</b>	<b>51P</b>
ARDOISE GRIS	ARDOISE BLANC
<b>57P</b>	<b>60P</b>
ARDOISE ECRU	ARDOISE NOIR
<b>52P</b>	<b>55P</b>
CALACATTA B.CO	AMANI GREY
<b>58P</b>	<b>61P</b>
GRAFITE OPACO	NERO MARQUINIA

<b>60</b>	<b>42</b>	<b>01</b>
BIANCO	LATTE NCS S 0502-G50Y	NUDE NCS S 1002-Y

<b>07</b>	<b>13</b>	<b>0F</b>
FANCY NCS S 2002-R50B	ELEGANT GREY NCS S 4500-N	ROMAN NCS S 6005-Y80R

<b>0A</b>	<b>26</b>	<b>04</b>
POWDER NCS S 0804-Y30R	AUTUMN BEIGE NCS S 1505-Y30R	COOKIE NCS S 2005-Y50R

<b>02</b>	<b>03</b>	<b>05</b>
ROYAL NCS S 2002-Y	NATURE NCS S 4005-Y20R	WILD NCS S 6005-Y20R

<b>0C</b>	<b>0D</b>	<b>0M</b>
SLATE NCS S 1502-B	TITANIUM NCS S 2005-G40Y	VENETIAN NCS S 3010-B30G

<b>0N</b>	<b>0P</b>	<b>0R</b>
CYPRUS NCS S 4020-B50G	TURQUOISE NCS S 4040-B20G	EUCALYPTUS NCS S 5540-B30G

<b>0S</b>	<b>0K</b>	<b>0L</b>
BAMBOU NCS S 7010-B50G	PISTACHO NCS S 4020-G50Y	LICHEN NCS S 5020-G30Y

<b>0B</b>	<b>0E</b>	<b>0G</b>
SAND NCS S 1005-Y70R	BISCUIT NCS S 2010-Y60R	EARTH NCS S 3010-Y30R

<b>0H</b>	<b>0J</b>	<b>11</b>
CURCUMA NCS S 4020-Y30R	AMBER NCS S 2050-Y20R	ROCK NCS S 2060-Y40R

<b>0I</b>	<b>0T</b>	<b>18</b>
HAVANA NCS S 3040-Y70R	TERRACOTTA NCS S 5030-Y90R	MASSAI NCS S 1580-R

<b>0Q</b>	<b>0V</b>	<b>06</b>
OCEAN NCS S 6020-R90B	DENIM NCS S 8010-R70B	DIVA NCS S 7005-Y80R

<b>0U</b>	<b>16</b>	<b>40</b>
MOCHA NCS S 8502-R	DEEP GREY NCS S 7500-N	URBAN NCS S 8000-N

<b>59</b>	<b>14</b>	<b>12</b>
NERO NCS S 9000-N	CORAL NCS S 0550-Y80R	BALLERINA NCS S 1020-Y70R

<b>08</b>	<b>10</b>	<b>15</b>
PRINCESS NCS S 0530-Y10R	ENJOY NCS S 0570-Y20R	PASSION NCS S 1085-Y90R

<b>85</b>	<b>90</b>	<b>75</b>
LUCKY NCS S 3060-G90Y	LAGOON NCS S 5040-G80Y	LAVANDER NCS S 3050-R60B

<b>98</b>	<b>0Y</b>	<b>0X</b>
SECRET NCS S 5040-R80B	SILK NCS S 2050-B	PASTEL NCS S 1030-B

# PREFAZIONE al Listino Prezzi

IL NOSTRO PERCORSO MOTIVAZIONALE ALLA CREAZIONE DI **MANUFATTI** PER LA CASA DEL VENTUNESIMO SECOLO

l'evoluzione dell'uomo nel tempo

processo di selezione delle Sette Meraviglie del Mondo Moderno e le vincitrici

l'evoluzione della casa nel tempo

un Occidente pacifico e la libertà di scegliere

IL VOSTRO PERCORSO MOTIVAZIONALE **ALLA SCELTA DI MANUFATTI** TDA PER LA CASA DEL VENTUNESIMO SECOLO

VISURA CAMERALE ORDINARIA DELLA SOCIETÀ DI CAPITALE T.D.A. S.R.L.

INDICE DEL LISTINO PREZZI TDA ARREDI.021

# PREFACE to the Price List

OUR MOTIVATIONAL PATH FOR THE CREATION OF **FURNISHING WORKS** OF THE TWENTY-FIRST CENTURY'S HOME

the human evolution throughout the years

selection process of the Modern World's Seven Wonders

the evolution of the house throughout the years

a peaceful West and the freedom of choice

YOUR MOTIVATIONAL PATH FOR THE CREATION OF **FURNISHING WORKS** OF THE TWENTY-FIRST CENTURY'S HOME

CHAMBER OF COMMERCE COMPANY REGISTRATION T.D.A. S.R.L.

INDEX OF PRICE LIST TDA ARREDI.021



Il frammento di Anassagora: **“l’uomo è intelligente perchè ha le mani”** intende dire che, proprio grazie alla dimensione manipolativa, l’uomo è riuscito a sopravvivere nel corso del tempo. A differenza dell’animale che resiste alle avversità naturali con la forza connessa spesso a un carattere istintivo, l’uomo cerca di risolvere i problemi servendosi dell’intelligenza e agendo di conseguenza: le mani sono lo strumento della ragione.  
(Mara Mazzocchi)

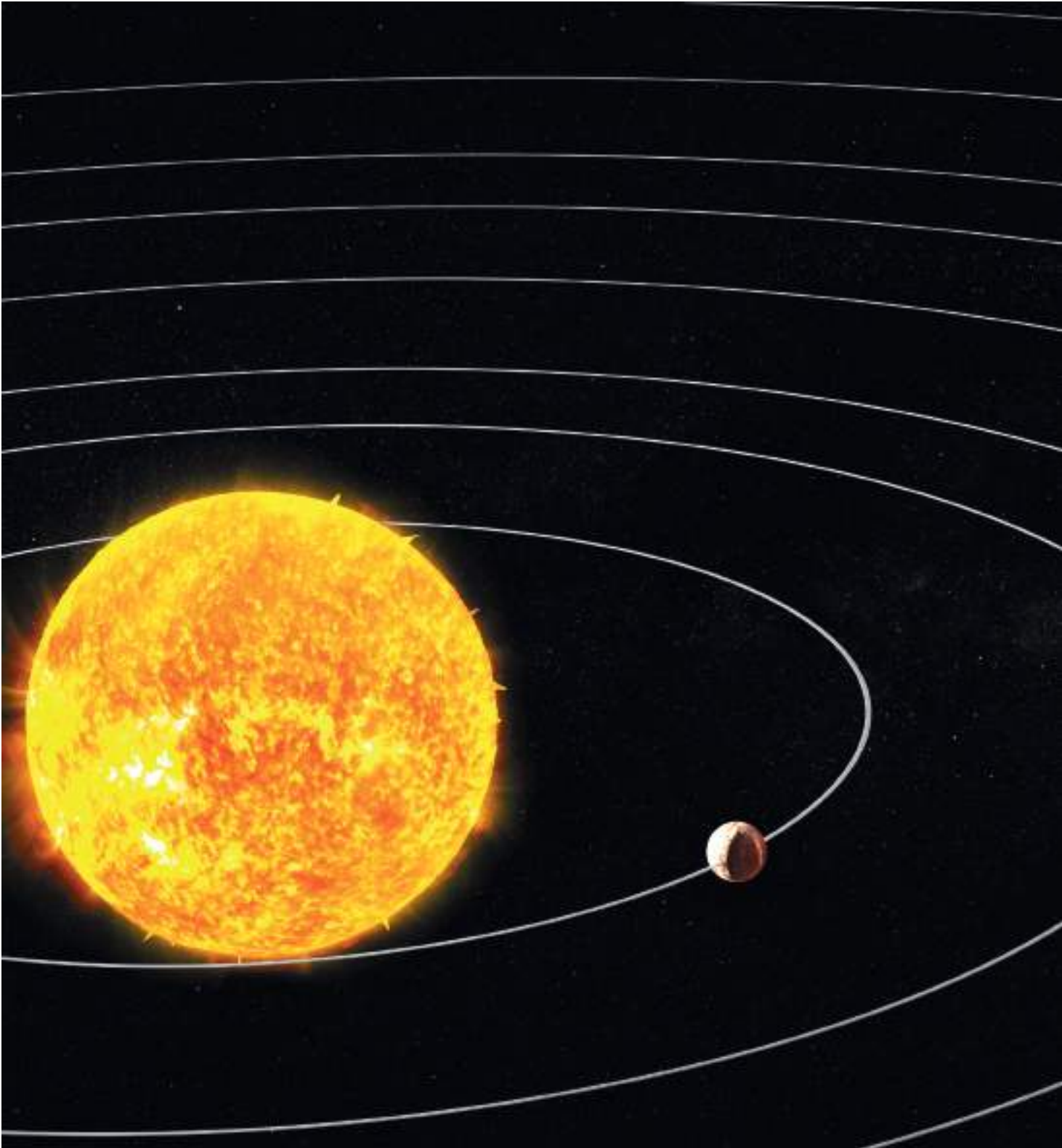

Un articolo recentemente pubblicato su *Proceeding of the National Academy of Sciences* attribuisce ai Neanderthal la paternità di alcuni antichi manufatti della categoria dei gioielli. Una prima datazione fa risalire i reperti a circa 40.000 anni fa nell'epoca di transizione e contatto in Europa tra Neanderthal e Sapiens.

Gli scienziati dell'Università di York hanno esaminato i reperti di ossa appartenute a un bambino Neanderthal vissuto nella stessa epoca di datazione dei gioielli e sono arrivati alla conclusione che **siano stati quindi i Neanderthal a creare i manufatti** anche se non si può escludere che li abbiamo ideati osservando i movimenti dei Sapiens.



## l'evoluzione dell'uomo nel tempo

3,2 milioni di anni fa: vive Lucy, la donna scimmia scoperta in Etiopia

2,1 milioni di anni fa: compare il genere umano con la specie Homo Habilis. Ha una dieta onnivora e utilizza **manufatti di pietra** per rompere le ossa degli animali e mangiarne il midollo

1,5 milioni di anni fa: l'Homo Erectus in Asia usa il fuoco e alcuni strumenti di legno, pietra e osso

500.000 anni fa: **compaiono i Neanderthal in tutta Europa. Si estinguono circa 40.000 anni fa**

200.000 anni fa: compare in Africa la specie Homo Sapiens

70.000 anni fa: **l'uomo, anatomicamente moderno esce dall'Africa, si espande in Asia e**

**Australia e arriva in Europa circa 45.000 anni fa**

33.000 anni fa: i primi artisti dell'arte rupestre

7.000 anni fa: gli stili costruttivi dei MEGALITI come Stonehenge in Inghilterra e dei DOLMEN come i famosi Allineamenti di Carnac

5.500 anni fa: **termina l'era della Pietra, inizia quella del Bronzo e gli uomini fondono i metalli**





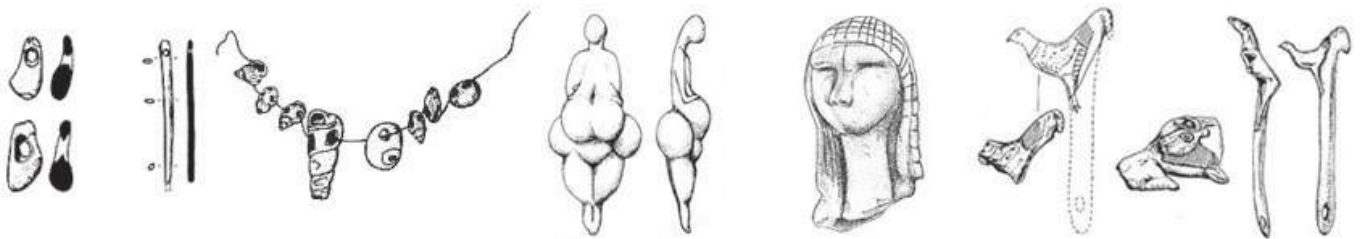



5.000 anni fa: il primo scritto riconosciuto

Risale al 312 a.C., 2.333 anni fa, **il più antico manufatto annoverato fra le sette meraviglie del mondo moderno**, sette opere architettoniche che idealmente richiamano l'antico elenco canonico risalente al III secolo a.C.



## processo di selezione delle sette meraviglie del mondo moderno e le vincitrici

durante i Giochi della XXVII Olimpiade nel 2000 a Sydney, lo svizzero-canadese Bernard Werber lancia via internet un referendum mondiale per determinare le "Nuove Sette Meraviglie del Mondo". Le prime 77 opere in ordine di voti sono sottoposte al vaglio di sette giudici internazionali. Il 1° gennaio 2006 sono rese note le 21 opere "finaliste". La proclamazione delle Nuove Sette Meraviglie del Mondo avviene a Lisbona il 7 luglio 2007, data scelta per la ricorsività del numero 7 (07/07/07). L'iniziativa è condotta dalla società Svizzera "New Open World Corporation"

<p>PETRA (312 a.C.)</p> <p>Giordania </p>	<p>GRANDE MURAGLIA CINESE (215 a.C.)</p> <p>Cina </p>	<p>COLOSSEO (80 d.C.)</p> <p>Italia </p>	<p>CHICHÉN ITZÁ (600 d.C.)</p> <p>Messico </p>
			



## l'evoluzione della casa nel tempo

l'uomo primitivo si pone il problema della casa quando inizia a spostarsi per trovare selvaggina e terra da coltivare. Deve così rinunciare a grotte e caverne imparando a costruire capanne.

Per difendersi dai nemici e dagli animali feroci progetta le palafitte in mezzo ai laghi, mentre gli Assiri Babilonesi e gli Etruschi usano per primi i mattoni.

Sono i Greci a posare tetti in argilla su case costruite con basamento di pietra e pareti in mattoni. Gli antichi Romani costruiscono le insule di quattro o cinque piani oltre alle domus delle famiglie più abbienti. Durante il Medioevo, a causa di continui conflitti e invasioni, le case si trasformano in castelli. Nel Rinascimento si scopre il gusto dell'ospitalità e si erigono i bei Palazzi Italiani mentre le Regge sono del periodo Barocco.

**Dall'inizio del secolo scorso si utilizzano mattoni forati, tegole e coppi per costruire abitazioni dotate di servizi igienici, acqua ed elettricità.** L'era moderna è caratterizzata dall'architettura organica che promuove l'armonia tra l'uomo e la natura e dall'architettura razionale che opta per le case alveari. Le popolazioni, in continuo aumento, abitano i condomini, le cascine e le case unifamiliari oltre agli alti palazzi e ai grattacieli. Il primo fu costruito a Chicago nel 1882 e il più alto è stato costruito nel 2009 a Dubai e conta bene 829 metri

## un Occidente pacifico e la libertà di scegliere

Steven Pinker, illustre illuminista del MET di Boston spiega **“perchè quella che stiamo vivendo è probabilmente l'epoca più pacifica della storia”** (*Il declino della violenza, 2011*).

Nell'ottobre 1660 il politico Samuel Pepys descrive nel suo diario, senza alcuna traccia di sgomento, l'uccisione del generale Harrison mentre veniva impiccato e squartato.

All'inizio dell'Età Moderna la pena di morte viene comminata per reati quali il pettegolezzo e il furto di cavoli e nel 1820 in Inghilterra i reati puniti con la morte sono 222 tra cui l'abbattimento di un albero.

In un'epoca in cui rifiutiamo il bullismo o una sculacciata non abbiamo idea di come venissero in passato cresciuti ed educati i più piccoli: la punizione corporale violenta è stata la norma per secoli.

A partire, simbolicamente, dalla Dichiarazione Universale dei Diritti Umani del 1948 si è sviluppata la sensibilità che ha portato alle battaglie per i diritti civili ed è cambiato il valore dato alla vita. **Un mutamento intellettuale e morale, un tangibile declino della violenza nella nostra esistenza quotidiana, tanto da permetterci il lusso di studiare, programmare, sognare, scegliere e preoccuparci d'invecchiare**

MACHU PICCHU  
(1450 d.C.)

Perù



TAJ MAHAL  
(1643 d.C.)

India



CRISTO REDENTORE  
(1931 d.C.)

Brasile



## VISURA CAMERALE ORDINARIA DELLA SOCIETÀ DI CAPITALE T.D.A. S.R.L.

**Camera di Commercio Industria Artigianato e Agricoltura di BRESCIA****Registro Imprese - Archivio Ufficiale delle CCIAA**

Visura ordinaria societa' di capitale

T.D.A. S.R.L.

**DATI ANAGRAFICI**

Sede legale	SAN GERVASIO BRESCIANO (BS) VIA CIRCONVALLAZIONE 1 cap 25020
Indirizzo PEC	T.D.A.SRL@LEGALMAIL.IT
Numero REA	BS - 423601
Codice fiscale e n.iscr. al Registro Imprese	02149150985
Partita IVA	02149150985
Codice LEI	8156005910A2FFC62E82
Forma giuridica	SOCIETA' A RESPONSABILITA' LIMITATA 03/11/2000
AMMINISTRATORE UNICO	DOMENEGHINI LUCA Rappresentante dell'Impresa

**ATTIVITA'**

Stato attività	attiva
Data inizio attività	10/02/2001
Attività prevalente	LA PRODUZIONE E LA RELATIVA COMMERCIALIZZAZIONE DI BOX DOCCIA, NONCHE' DI PIATTI DOCCIA E ARREDI PER LA CASA
Codice ATECO	25.99.19
Codice NACE	25.99
Attività import export	-
Contratti di rete	-
Albi e ruoli e licenze	sì
Albi e registri ambientali	-

**L'IMPRESA IN CIFRE**

Capitale sociale	1.500.000,00
Addetti al 31/12/2020	128
Soci	2
Amministratori	1
Titolari di cariche	1
Sindaci, organi di controllo	1
Unità locali	3

*Le tabelle sovrastanti espongono un estratto delle informazioni presenti in visura che non può essere considerato esaustivo, ma che ha puramente scopo di sintesi*

## INDICE DEL LISTINO PREZZI TDA ARREDI.021

SISTEMA PER ARREDARE CON LA RACCOLTA DEI PRODOTTI AROCK®	UNICAMENTE AROCK®	
	DISSEMINATI NEL LISTINO PREZZI	
FILOPIANO LAVABO INTEGRATO SOSPESO	ALCENTIMETRO	
PIANO SOSPESO	ALCENTIMETRO	
FILOPIANO LAVABO INTEGRATO PER MOBILI	ALCENTIMETRO	
PIANO PER MOBILI	ALCENTIMETRO	
PIANO PER BASI D'ARREDO	ALCENTIMETRO	
LAVABO SOPRAPIANO DA APPOGGIO		
LAVABO SOPRAPIANO E SOTTOPIANO DA INCASSO		
SPECCHIO CON CORNICE		
PORTASALVIETTE	FREE-STANDING	
COLONNINA		
POMOLO	PORTASALVIETTE	
MENSOLA	NON ALCENTIMETRO	
MENSOLA	CON PORTASALVIETTE - NON ALCENTIMETRO	

SISTEMA PER ARREDARE CON I NOSTRI PRODOTTI IN QUARANTOTTO COLORI	ALCENTIMETRO PROGETTO	
	E CON LE VOSTRE MISURE	
PIANI SOSPESI	TUTTI	
FILOPIANO LAVABO INTEGRATO SOSPESO	AROCK®	
SHAMBOLA®	CONSOLE PER LAVABO	
SHAMBOLA®	CONSOLE PER LAVABO CON TAVOLO	
SHAMBOLA®	CONSOLE PER TAVOLO E TAVOLO DA INGRESSO	
FILOPIANO LAVABI INTEGRATI PER MOBILI		
PIANI PER MOBILI		
PIANI PER BASI D'ARREDO		
SPECCHI LINEO E AERO	REVERSIBILI	
MENSOLA	IN NOBILITATO E LACCATO OPACO/LUCIDO	
PANCA		
BANCONCONE		
ZOCCOLO D'ARREDO H 3		

ELEMENTI	CONTENITORI
PER CREARE E COMPLETARE UN ARREDAMENTO	
tutte le BASI D'ARREDO	
tutti i PENSILI CON ANTA SPECCHIATA	
tutti i PENSILI	
tutti i PENSILI A GIORNO	SOLO VERTICALI
tutte le COLONNE	
tutte le COLONNE A GIORNO	SOLO VERTICALI

ELEMENTI	COMPLEMENTARI
PER CREARE E COMPLETARE UN ARREDAMENTO	
tutti i LAVABI	NON ALCENTIMETRO
tutti gli SPECCHI	NON ALCENTIMETRO
tutte le LAMPADE	
VANI A GIORNO	SOLO ORIZZONTALI
PORTASALVIETTE	FREE-STANDING
PORTASALVIETTE	A MURO
MENSOLA	CON PORTASALVIETTE NON ALCENTIMETRO
MENSOLA	NON ALCENTIMETRO
COLONNINA	
POMOLO	PORTASALVIETTE IN AROCK®

## MOBILI DISEGNATI

SHAMBOLA®

di PAOLO SALVADÈ

TALETE

di PAOLO SALVADÈ

HAIKU

di T\_FELDER

## MOBILI COMPATTI

ONESTO

LIBERO

## MOBILI COMPONENTI

LEALE

GIUSTO

## MOBILI LAVANDERIA

AUDACE







OUR MOTIVATIONAL PATH FOR THE CREATION OF **FURNISHING WORKS** OF THE TWENTY-FIRST CENTURY'S HOME

The fragment of Anassagora: “**human beings are intelligent because they have hands**” means that thanks to the manipulative dimension that humans have, they were able to survive throughout the years. Contrary to animals that can resist to the natural adversities with their strength, which is often related to an instinctive behavior, humans try to solve problems using the intellect: the hands are the vehicle of the reasoning (Mara Mazzocchi)

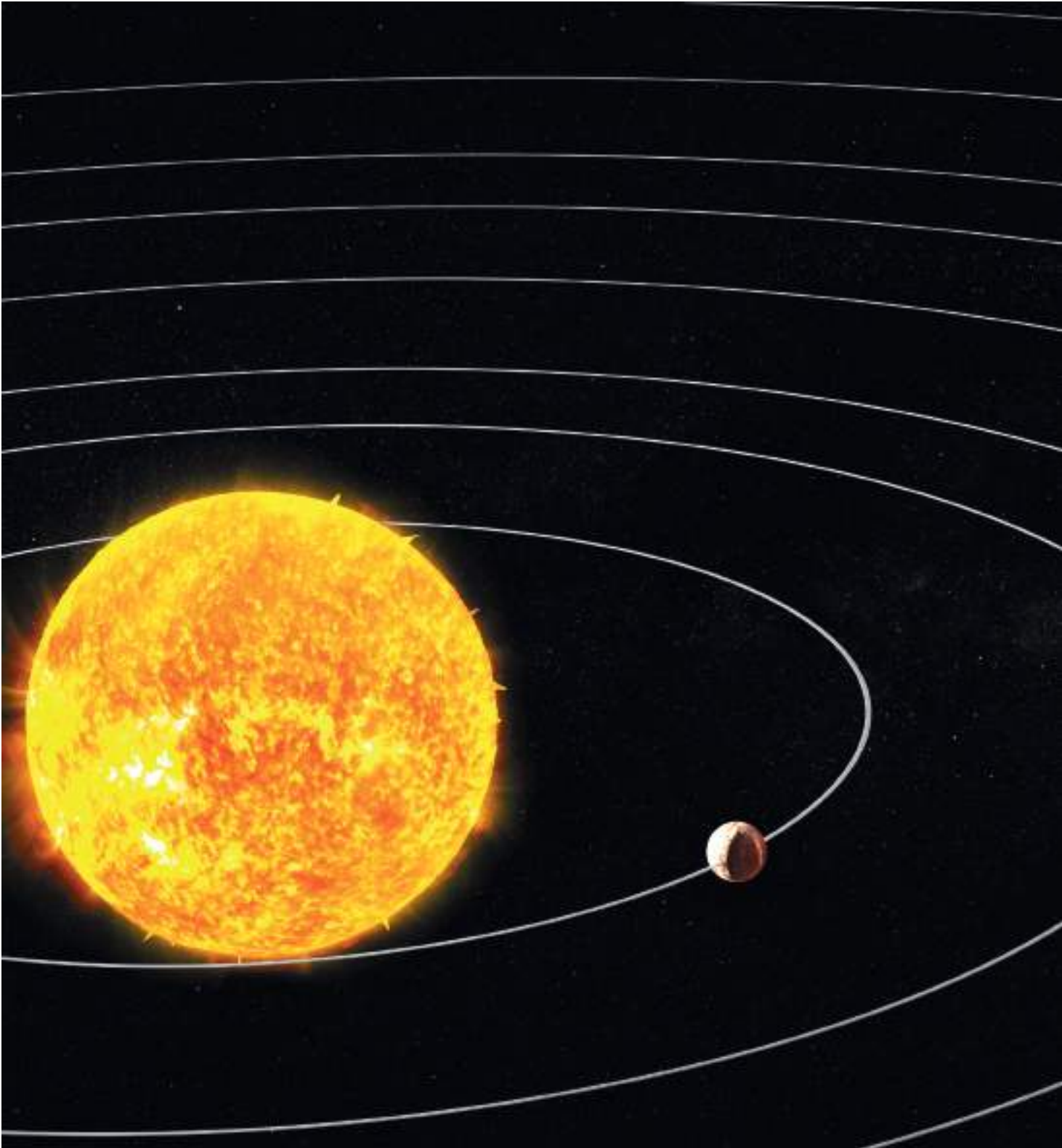

A recently published article by the Proceeding of the National Academy of Science attributes to the Neanderthal the pathernity of some ancient jewelry's works. The finds are dated approximately to 40.000 years ago, during the age of transition from the Neanderthal to the Sapiens in Europe. The scientists at the York University have studied the bone's finds of a Neanderthal child that lived in the same time of the dated jewelry. From their studies, the scientists have concluded that **the Neanderthal have created those works**, even if, it is not possible to exclude the hypothesis that they were created by observing the Sapiens' movements



## the human evolution throughout the years

3,2 Millions of yeras ago: Lucy, the monkey woman discovered in Ethiopia, lives

2,1 Millions of years ago: the mankind appears with the Homo Abilis. It has an omnivorous diet and uses **stone works** to break the animals' bones and eat the marrow

1,5 Millions of years ago: the Homo Herectus in Asia uses the fire and some wood, stone, and bone instruments

500.000 years ago: **the Neanderthal appears in Europe. 40.000 years ago they were extinguished**

200.000 years ago: the Homo Sapiens appears in Africa

70.000 years ago: **the mankind, anatomically modern, gets out from Africa and travels to Asia and Australia. Approximately, 45.000 years ago, the mankind arrives to Europe as well**

33.000 years ago: first artists of the rupestrian art

7.000 years ago: the consructive styles of both the MEGALITHS, such as Stonehenge in the United Kingdom, and the DOLMEN, such as the famous Carnac Stones

5.500 years ago: **the Stone Age ends and the Bronze Age begins. With the beginning of this latter age, men start melting the metals**





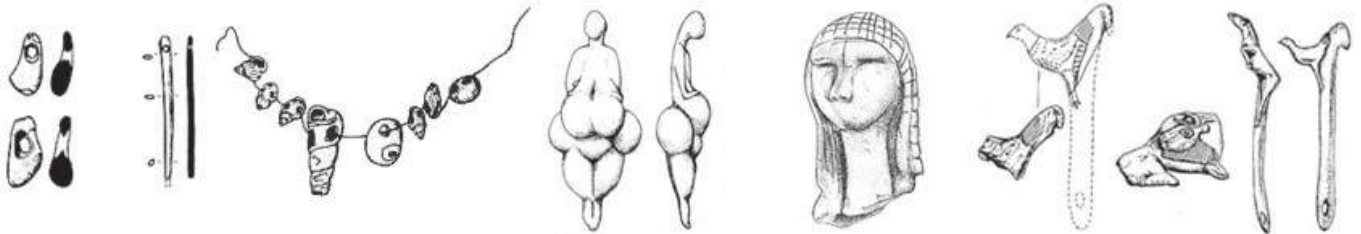

5.000 years ago: the first recognized writing

**The most ancient work of the Modern World's Seven Wonders**, which are the seven architectural works that ideally recall the ancient Canonical List of the III Century b.C., is dated back to the 312 b.C., 2.333 years ago

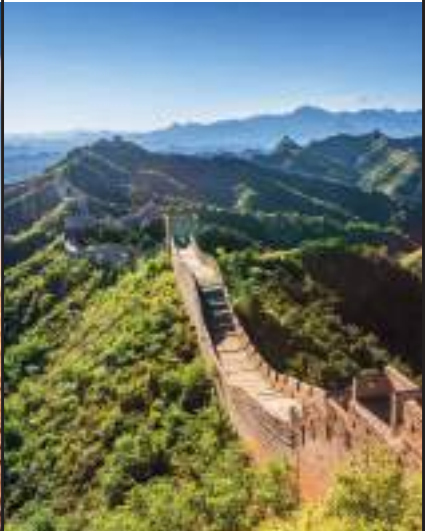

## selection process of the Modern World's Seven Wonders

during the XXVII Olympic Games, which occurred in Sydney in 2000, Bernard Werber, a Swiss-Canadian participant, launched a world referendum via Internet to establish the "New World's Seven Wonders". The first 77 works, in order of voting, were judged by seven international experts. On January 1<sup>st</sup>, 2006, the seven experts revealed the 21 finalist works. The official decision on the New World's Seven Wonders took place in Lisbon on July 7<sup>th</sup>, 2007. This date was chosen because of the recursion of the number 7 (07/07/07). The initiative was directed by the Swiss organization "New Open World Corporation"

<p>PETRA (312 a.C.)</p> <p>Giordania </p>	<p>GRANDE MURAGLIA CINESE (215 a.C.)</p> <p>Cina </p>	<p>COLOSSEO (80 d.C.)</p> <p>Italia </p>	<p>CHICHÉN ITZÁ (600 d.C.)</p> <p>Messico </p>
			



## the evolution of the house throughout the years

the primitive man thinks about the house when he begins going around to find game and land to cultivate. As a result, he has to give up the caves to learn how to build the huts. To defend from the enemies and fierce animals, the man designs the stilts in the middle of the lakes. On the other side, the Assyrian-Babilonian and the Etruscan are the first ones to use the brick. The Greek are the ones that construct the house with clay roofs, stone base, and brick walls. The ancient Romans build the insulae with four or five floors, in addition to the domus of the wealthy families. During the Middle Ages, due to the incessant conflicts and invasions, the houses were transformed in castles. In the Renaissance, the taste for the hospitality was discovered and the beautiful Italian palaces (Palazzi) emerged. The royal palaces (Regge) were built during the age of the Baroque. **Since the beginning of the last century, hollow bricks, tiles, and roof tiles have been used to build homes with hygienic services, water, and electricity.** The modern era is characterized by the organic architecture that promotes the harmony between the human and the nature. Moreover, it is marked by the rational architecture that opts for the beehive houses. The population, constantly increasing, lives in condominiums, farmhouses, and single-family houses. In addition, they live in tall buildings and skyscrapers. The first one was built in Chicago in 1882 and the tallest one was built in 2009 in Dubai, which is 829 m tall

## a peaceful West and the freedom of choice

Steven Pinker, renowned Illuminist of the Boston MED, explains “**the reason why the age that we are living is probably the most peaceful period in history**” (Il declino della violenza, 2011). In October, 1660, the politician Samuel Pepys described in his diary, without any sign of dismay, the killing of the General Harrison while he was hanged and quartered. At the beginning of the Modern Age, the death penalty was imposed for offences, such as rumor and the stealing of cabbage. In the 1820 in the United Kingdom, the offences, punished with the death penalty, were 222, within which the cutting down of a tree. During an age in which people condemns the bullism and a spanking, they do not have idea of how the children were educated and raised in the past: the violent physical punishment has been the custom for many centuries. Symbolically, starting from the 1948 Universal Declaration of Human Rights the sensibility has been developed, which has brought to the fights for the civil rights. As a result, it has changed the value of life. **This is the sign of a moral and intellectual changing and a tangible decline of the violence in people’s daily existence. This has given to the people the benefit of studying, planning, dreaming, choosing, and worrying about getting old**

MACHU PICCHU  
(1450 d.C.)

Perù



TAJ MAHAL  
(1643 d.C.)

India



CRISTO REDENTORE  
(1931 d.C.)

Brasile



## CHAMBER OF COMMERCE COMPANY REGISTRATION T.D.A. S.R.L.

**Camera di Commercio Industria Artigianato e Agricoltura di BRESCIA****Registro Imprese - Archivio Ufficiale delle CCIAA**

Visura ordinaria societa' di capitale

T.D.A. S.R.L.

**DATI ANAGRAFICI**

Sede legale	SAN GERVASIO BRESCIANO (BS) VIA CIRCONVALLAZIONE 1 cap 25020
Indirizzo PEC	T.D.A.SRL@LEGALMAIL.IT
Numero REA	BS - 423601
Codice fiscale e n.iscr. al Registro Imprese	02149150985
Partita IVA	02149150985
Codice LEI	8156005910A2FFC62E82
Forma giuridica	SOCIETA' A RESPONSABILITA' LIMITATA 03/11/2000
AMMINISTRATORE UNICO	DOMENEGHINI LUCA Rappresentante dell'Impresa

**ATTIVITA'**

Stato attività	attiva
Data inizio attività	10/02/2001
Attività prevalente	LA PRODUZIONE E LA RELATIVA COMMERCIALIZZAZIONE DI BOX DOCCIA, NONCHE' DI PIATTI DOCCIA E ARREDI PER LA CASA
Codice ATECO	25.99.19
Codice NACE	25.99
Attività import export	-
Contratti di rete	-
Albi e ruoli e licenze	sì
Albi e registri ambientali	-

**L'IMPRESA IN CIFRE**

Capitale sociale	1.500.000,00
Addetti al 31/12/2020	128
Soci	2
Amministratori	1
Titolari di cariche	1
Sindaci, organi di controllo	1
Unità locali	3

## INDEX OF PRICE LIST TDA ARREDI.021

SISTEMA PER ARREDARE CON LA RACCOLTA DEI PRODOTTI AROCK®	UNICAMENTE AROCK®	
	DISSEMINATI NEL LISTINO PREZZI	
FILOPIANO LAVABO INTEGRATO SOSPESO	ALCENTIMETRO	
PIANO SOSPESO	ALCENTIMETRO	
FILOPIANO LAVABO INTEGRATO PER MOBILI	ALCENTIMETRO	
PIANO PER MOBILI	ALCENTIMETRO	
PIANO PER BASI D'ARREDO	ALCENTIMETRO	
LAVABO SOPRAPIANO DA APPOGGIO		
LAVABO SOPRAPIANO E SOTTOPIANO DA INCASSO		
SPECCHIO CON CORNICE		
PORTASALVIETTE	FREE-STANDING	
COLONNINA		
POMOLO	PORTASALVIETTE	
MENSOLA	NON ALCENTIMETRO	
MENSOLA	CON PORTASALVIETTE - NON ALCENTIMETRO	

SISTEMA PER ARREDARE CON I NOSTRI PRODOTTI IN QUARANTOTTO COLORI	ALCENTIMETRO PROGETTO	
	E CON LE VOSTRE MISURE	
PIANI SOSPESI	TUTTI	
FILOPIANO LAVABO INTEGRATO SOSPESO	AROCK®	
SHAMBOLA®	CONSOLE PER LAVABO	
SHAMBOLA®	CONSOLE PER LAVABO CON TAVOLO	
SHAMBOLA®	CONSOLE PER TAVOLO E TAVOLO DA INGRESSO	
FILOPIANO LAVABI INTEGRATI PER MOBILI		
PIANI PER MOBILI		
PIANI PER BASI D'ARREDO		
SPECCHI LINEO E AERO	REVERSIBILI	
MENSOLA	IN NOBILITATO E LACCATO OPACO/LUCIDO	
PANCA		
BANCONCONE		
ZOCCOLO D'ARREDO H 3		

ELEMENTI	CONTENITORI
PER CREARE E COMPLETARE UN ARREDAMENTO	
tutte le BASI D'ARREDO	
tutti i PENSILI CON ANTA SPECCHIATA	
tutti i PENSILI	
tutti i PENSILI A GIORNO	SOLO VERTICALI
tutte le COLONNE	
tutte le COLONNE A GIORNO	SOLO VERTICALI

ELEMENTI	COMPLEMENTARI
PER CREARE E COMPLETARE UN ARREDAMENTO	
tutti i LAVABI	NON ALCENTIMETRO
tutti gli SPECCHI	NON ALCENTIMETRO
tutte le LAMPADE	
VANI A GIORNO	SOLO ORIZZONTALI
PORTASALVIETTE	FREE-STANDING
PORTASALVIETTE	A MURO
MENSOLA	CON PORTASALVIETTE NON ALCENTIMETRO
MENSOLA	NON ALCENTIMETRO
COLONNINA	
POMOLO	PORTASALVIETTE IN AROCK®

## MOBILI DISEGNATI

SHAMBOLA®

di PAOLO SALVADÈ

TALETE

di PAOLO SALVADÈ

HAIKU

di T\_FELDER

## MOBILI COMPATTI

ONESTO

LIBERO

## MOBILI COMPONENTI

LEALE

GIUSTO

## MOBILI LAVANDERIA

AUDACE

*the identical color applied  
to the different materials  
the Italian creativity and aesthetics' Manifesto  
involved in the sustainable production  
of shower enclosures and trays,  
furniture and its complements*

il risultato identico del colore  
nei diversi materiali  
manifesto della creatività e teatralità italiana  
applicato alla produzione sostenibile  
di piatti e pareti doccia  
arredi e complementi

LA DEFINIZIONE DELLA BRAND IMAGE TDA.  
THE DEFINITION OF THE BRAND IMAGE TDA.

*glass*  
vetro

*aluminum*  
alluminio

*lacquered*  
laccato

AROCK®



**TDA**®



# TDA Srl - Brescia, Lombardia (IT)





FRANCIACORTA - Brescia, Lombardia (IT)



LAGO DI GARDA - Brescia, Lombardia (IT)



CAVE DI MARMO BOTTICINO - Brescia, Lombardia (IT)

TDA si riserva, a proprio insindacabile giudizio, di apportare modifiche anche senza preavviso, allo scopo di migliorare la produzione.

TDA reserves the right to modify the products without advance notice to improve the production

TDA se réserve le droit, à sa seule discrétion, d'apporter des modifications sans préavis afin d'améliorer la production

TDA vorbehaltet sich das Recht, ohne Voranmeldung, wesentliche Änderungen für eine Verbesserung der Produktion einzuführen

TDA srl  
via Circonvallazione, 1  
I-25020 San Gervasio Bresciano (BS)  
tel. +39 030 9926311  
fax +39 030 9926312  
[www.tda.it](http://www.tda.it)  
[info@tda.it](mailto:info@tda.it)

TDA United Kingdom  
tel. +39 030 9926340  
fax +39 030 9926312  
[www.tda.it](http://www.tda.it)  
[sales@tda.it](mailto:sales@tda.it)

TDA France  
tel. +33 04 72 28 04 98  
fax +33 04 72 28 04 99  
[www.tdafrance.fr](http://www.tdafrance.fr)  
[info@tdafrance.fr](mailto:info@tdafrance.fr)

TDA Deutschland  
tel. +49 (0)37323 573 599  
fax +39 030 9926312  
[www.tda.it](http://www.tda.it)  
[verkauf@tda.it](mailto:verkauf@tda.it)

printed in Italy in 07\_021

ARREDI.021

021 / euro

TDA®

021 / euro



# Arredi

	Descrizione modello Model description Descriptif du modèle Modellbeschreibung	Categorie di prezzo Price classification Classification tarifaire Wichtige Hinweise	Rubricatura Index Index Index																
	<p><b>Basi</b> Units</p> <p>UNICAMENTE AROCK®</p> <p>ALCENTIMETRO PROGETTO</p> <p>Elementi CONTENITORI</p> <p>Elementi COMPLEMENTARI</p> <p>RICAMBI</p> <p>34 98 180 226 592</p>		497																
Icone Icons Pictogramme Symbol																			
Caratteristiche Features Caractéristiques Eigenschaften																			
Altezza Height Hauteur Höhe																			
Disegno modello Template Modèle Schablonendesign																			
Info tecniche Technical info Infos techniques Technische Infos																			
Larghezza Width Largeur Breite																			
Codice Code Code article Code																			
Prezzi Prices Prix Preise																			
	<p><b>H 50</b></p> <p><b>P 45</b></p> <p>Sistema Premi-Apri • base portlavabo • 2 cassetti • scasso per sifone dx Premi-Apri System • vanity unit • 2 pull-out • right cavity for siphon Système Premi-Apri • meuble sous vasque • 2 tiroirs • trou droite pour le siphon Premi-Apri System • Waschtischunterschrank • 2 Schubladen • Siphonousschnitt-rechts</p> <table border="1"> <tr> <th>L</th> <th>F1</th> <th>F2</th> <th>F3</th> </tr> <tr> <td>105 N1L10516</td> <td>625</td> <td>685</td> <td>545</td> </tr> </table> <p><b>P 51,5</b></p> <table border="1"> <tr> <th>L</th> <th>F1</th> <th>F2</th> <th>F3</th> </tr> <tr> <td>105 N1L10566</td> <td>670</td> <td>735</td> <td>585</td> </tr> </table>	L	F1	F2	F3	105 N1L10516	625	685	545	L	F1	F2	F3	105 N1L10566	670	735	585		
L	F1	F2	F3																
105 N1L10516	625	685	545																
L	F1	F2	F3																
105 N1L10566	670	735	585																
	<p><b>H 50</b></p> <p><b>P 45</b></p> <p>Sistema Premi-Apri • base portlavabo • 2 cassetti • scasso per sifone sx Premi-Apri System • vanity unit • 2 pull-out • left cavity for siphon Système Premi-Apri • meuble sous vasque • 2 tiroirs • trou gauche pour le siphon Premi-Apri System • Waschtischunterschrank • 2 Schubladen • Siphonousschnitt-links</p> <table border="1"> <tr> <th>L</th> <th>F1</th> <th>F2</th> <th>F3</th> </tr> <tr> <td>105 N1L10517</td> <td>625</td> <td>685</td> <td>545</td> </tr> </table> <p><b>P 51,5</b></p> <table border="1"> <tr> <th>L</th> <th>F1</th> <th>F2</th> <th>F3</th> </tr> <tr> <td>105 N1L10567</td> <td>670</td> <td>735</td> <td>585</td> </tr> </table>	L	F1	F2	F3	105 N1L10517	625	685	545	L	F1	F2	F3	105 N1L10567	670	735	585		
L	F1	F2	F3																
105 N1L10517	625	685	545																
L	F1	F2	F3																
105 N1L10567	670	735	585																
	<p><b>H 50</b></p> <p><b>P 45</b></p> <p>Sistema Premi-Apri • base portlavabo • 2 cassetti • scasso per sifone doppio Premi-Apri System • vanity unit • 2 pull-out • double cavity for siphon Système Premi-Apri • meuble sous vasque • 2 tiroirs • trou pour le siphon double Premi-Apri System • Waschtischunterschrank • 2 Schubladen • Siphonousschnitt-doppelt</p> <table border="1"> <tr> <th>L</th> <th>F1</th> <th>F2</th> <th>F3</th> </tr> <tr> <td>120 N1L12011</td> <td>655</td> <td>720</td> <td>570</td> </tr> </table> <p><b>P 51,5</b></p> <table border="1"> <tr> <th>L</th> <th>F1</th> <th>F2</th> <th>F3</th> </tr> <tr> <td>120 N1L12061</td> <td>700</td> <td>770</td> <td>610</td> </tr> </table>	L	F1	F2	F3	120 N1L12011	655	720	570	L	F1	F2	F3	120 N1L12061	700	770	610		
L	F1	F2	F3																
120 N1L12011	655	720	570																
L	F1	F2	F3																
120 N1L12061	700	770	610																
	<p>Misure in cm Measures in cm Mesures en cm Maße in cm</p> <p><b>F1</b> Laccato lucido Glossy lacquered Laqué brillant Hochglanz lackiert</p> <p><b>F2</b> Laccato opaco Matt lacquered Laqué mat Matt lackiert</p> <p><b>F3</b> Nobilitati Veneer wood Placage bois Beschichtetes Holz</p> <p><b>F4</b> Arock® Arock® Arock® Arock®</p> <p><b>F5</b> abitat / vogue abibat / vogue abibat / vogue abibat / vogue</p>																		



**codice d'ordine**  
**order code**

**code commande**  
**Bestellcode**

**MOBILE / UNIT / MEUBLE / UNTERSCHRANK**

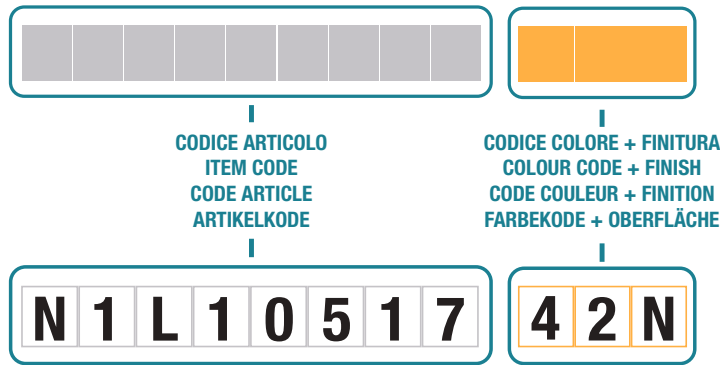

**CODICE ARTICOLO**  
**ITEM CODE**  
**CODE ARTICLE**  
**ARTIKELCODE**

**CODICE COLORE + FINITURA**  
**COLOUR CODE + FINISH**  
**CODE COULEUR + FINITION**  
**FARBECODE + OBERFLÄCHE**

**C = Laccato opaco**  
**N = Laccato lucido**  
**W = Nobilitato Legno**  
**I = Nobilitato Altatto**  
**H = Arock®**

<b>H 50</b>	<b>P 45</b>	<b>P 51,5</b>							
	Sistema Premi-Apri • base portalavabo • 2 cassetti • scasso per sifone sx Premi-Apri System • vanity unit • 2 pull-out • left cavity for siphon Système Premi-Apri • meuble sous vasque • 2 tiroirs • trou gauche pour le siphon Premi-Apri System • Waschtischunterschrank • 2 Schubladen • Siphonousschnitt-links								
<b>L</b>	<b>F1</b>	<b>F2</b>	<b>F3</b>	<b>L</b>	<b>F1</b>	<b>F2</b>	<b>F3</b>		
105	N1L10517	625	685	545	105	N1L10567	670	735	585

MOBILI COMPONIBILI - LEALE

**PIANO / TOP / PLAN / PLATTE**

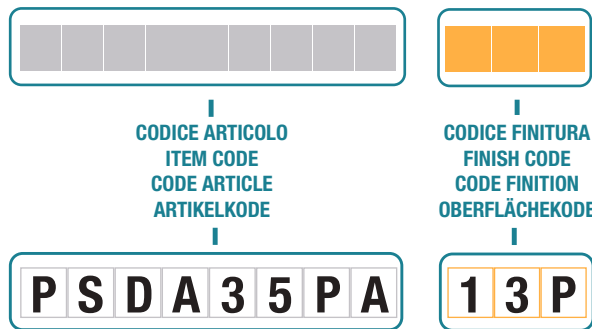

**CODICE ARTICOLO**  
**ITEM CODE**  
**CODE ARTICLE**  
**ARTIKELCODE**

**CODICE FINITURA**  
**FINISH CODE**  
**CODE FINITION**  
**OBERFLÄCHECODE**

<b>01P</b>	<b>02P</b>	<b>05P</b>	<b>03P</b>	<b>04P</b>	<b>07P</b>
<b>09P</b>	<b>10P</b>	<b>11P</b>	<b>13P</b>	<b>14P</b>	<b>15P</b>

cod.	P	H	al cm lineare per linear cm au cm linéaire pro cm
PSDA18PA	18	1	1,4 €
PSDA35PA	34	1	2,3 €
PSDA37PA	37	1	2,8 €

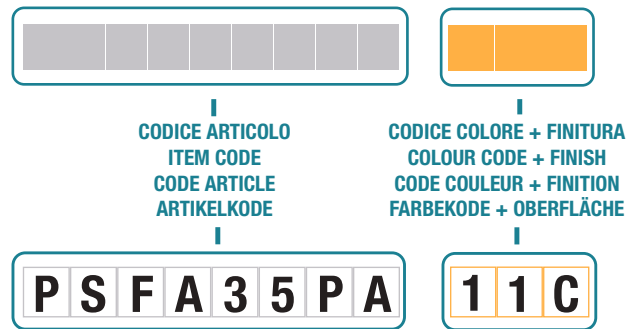

**CODICE ARTICOLO**  
**ITEM CODE**  
**CODE ARTICLE**  
**ARTIKELCODE**

**CODICE COLORE + FINITURA**  
**COLOUR CODE + FINISH**  
**CODE COULEUR + FINITION**  
**FARBECODE + OBERFLÄCHE**

<b>PSFA18PA</b>	<b>PSFA35PA</b>	<b>PSFA37PA</b>
-----------------	-----------------	-----------------

cod.	P	H	F1	F2
PSFA18PA	18	1,8	0,7 €	0,8 €
PSFA35PA	34	1,8	0,8 €	1,0 €
PSFA37PA	37	1,8	0,9 €	1,2 €

**P = HPL / Castmarble / Tecnoril**  
**Cristallo / Pietra naturale**  
**Silestone / Gres**  
**C = Laccato opaco**  
**N = Laccato lucido**  
**W = Nobilitato Legno**  
**I = Nobilitato Altatto**  
**H = Arock®**

## su misura bespoke

## sur mesure Maßgefertigt

per rispondere alle esigenze della clientela i mobili con anta possono essere modificati riducendo le dimensioni in altezza, in larghezza e in profondità ogni variazione comporta un sovrapprezzo del **15%**

le modifiche sui mobili con cassetto prevedono la richiesta all'ufficio tecnico TDA

i tempi di consegna possono aumentare di 2 settimane rispetto alla normale tempistica

in order to cope with all possible demands, the units with door can be modified with a reduction in height, width, and depth

every customisation on demand implies a price surcharge percentage of **15%**

all customisations on units with drawers imply a precise request to the TDA technical department

standard delivery times may indicatively be extended to 2 weeks

pour répondre aux demandes les plus différentes, les meubles avec portes peuvent être modifiés en réduisant les dimensions en hauteur, largeur et profondeur

chaque modification implique un surcoût de **15%**

les modifications sur les meubles avec tiroirs doivent être vérifiées par le service technique de TDA





le délais standard de livraison peut être allongé de 2 semaines

um auf die Forderung der Kundschaft zu entsprechen, können die Möbel mit Türen in Höhe, in der Breite sowie in der Tiefe reduziert werden

jede Änderung sieht einen **15%** Preisaufschlag

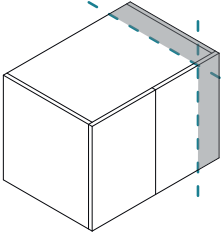
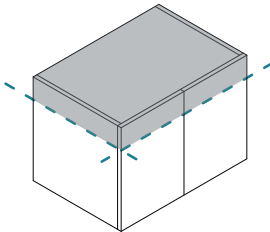
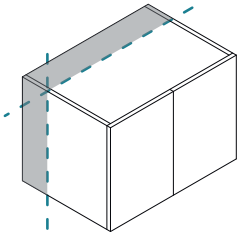
jede Änderung von Möbeln mit Schubladen muß dem technischen Abteilung von TDA weitergeleitet werden

die Standardliefertermine können ungefähr 2 Wochen verspätet werden

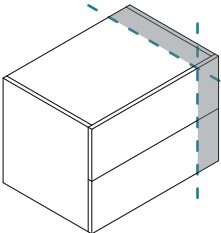
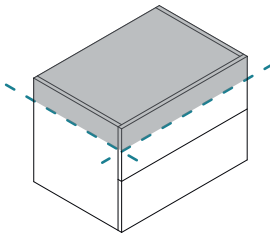
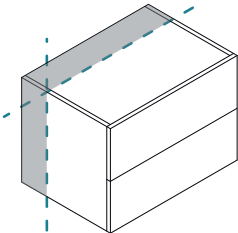
	LARGHEZZA / WIDHT LARGEUR / BREITE	ALTEZZA / HEIGHT HAUTEUR / HÖHE	PROFONDITA' / DEPT PROFONDEUR / TIEFE
ANTE / DOORS PORTES / TÜREN	+ 15%	+ 15%	+ 15%
			
CASSETTI / DRAWERS TIROIRS / SCHUBLADEN			
			

### esempio example

taglio in larghezza **+ 15%**  
cut in length  
coupe en largeur  
Schnitt in der Breite

### exemple Beispiel

taglio in profondità **+ 15%**  
cut across depth  
coupe en profondeur  
Schnitt in der Tiefe

maggiorazione totale **+ 30%**  
total calculation  
calcul total  
gesamtpreis erhöht

## a richiesta on demand



+ 10%



## sur demande auf Nachfrage

i 48 **colori.02** sono selezionati dalla cartella NCS - Natural Color System®. Viene applicata una maggiorazione del **10%** per ogni modifica richiesta di colore / elemento. I tempi di consegna possono aumentare di 2 settimane rispetto alla normale tempistica

the 48 **colori.02** have been selected from the NCS - Natural Color System®. It is possible to customise every element (fronts, side panels, toe-kick, handle and handle profile) with a different colour of the same char. This implies an extra **10%** on the price of every single modified element. Standard delivery times may be extended about 2 weeks

les 48 **colori.02** ont été sélectionnées à partir du nuancier NCS - Natural Color System®. Il est possible de personnaliser chaque élément avec une autre couleur du même nuancier et avec un surcoût de **10%** sur le prix de chaque élément modifié. Les délais standard de livraison peuvent être allongés de 2 semaines

die 48 Farben der **colori.02** Palette sind eine Auswahl aus dem NCS - Natural Color System®. Man kann alle Elemente mit einer verschiedenen Farbe der selben Tabelle personalisieren. Jede einzelne Personalisierung bringt mit sich einen **10%** Preisaufschlag. Die Standardliefertermine können 2 Wochen verspätet werden

per ordini inferiori a € 900 si richiede un contributo di formulazione pari a € 70 per ogni colore extra

for orders of less than € 900, a formulation charge of € 70 is due for every new extra colour

pour les commandes inférieures à € 900, une majoration de € 70 pour la formulation de chaque couleur supplémentaire est appliquée

für Bestellungen mit einem Gesamtbetrag unter € 900, wird ein Beitrag von € 70 für jede zusätzliche Farbe verrechnet

## smaltimento imballo packaging disposal

gli imballi utilizzati da TDA possono essere riciclati come previsto dalle normative vigenti, TDA assolve al contributo CONAI ove dovuto

the packaging used by TDA can be recycled in accordance with current regulations, TDA takes care of the CONAI environmental charge

les emballages que TDA utilise peuvent être recyclés comme prévu par les réglementations en vigueur, TDA paie les frais CONAI ou dues

TDA Verpackungen können in Übereinstimmung mit den aktuell gültigen Normen wieder verwertet werden, TDA zahlt den Conai-Beitrag falls fällig

## élimination de l'emballage Verpackungsentsorgung





#### CONTENITORI / CORPUS / MEUBLES / MOEBEL

fianchi, tetto e fondo realizzati con pannelli di particelle di legno idrorepellenti spessore 16 o 18 mm a basso contenuto di formaldeide nelle seguenti conformazioni:

- . (A) nobilitati con carta melaminica colore URBAN all'interno e laccati con vernici poliuretatiche in finitura opaco o lucido all'esterno; bordi in ABS in finitura
- . (B) nobilitati con carta melaminica finitura LEGNO riprodotto ad alta fedeltà, sia interno che esterno; bordi in ABS in finitura
- . schienale realizzato con pannelli in MDF spessore 3 mm nobilitato con polipropilene due lati in finitura URBAN

wood particles panel 16 or 18 mm with low formaldehyde content:

- . (A) internal parts covered with Nobilitato URBAN colour, external parts matt/glossy lacquered, ABS edges
- . (B) internal and external parts covered with Nobilitato LEGNO, ABS edges
- . back part in MDF panel 3 mm Nobilitato URBAN

panneaux de particules de bois 16 ou 18 mm à faible teneur en formaldéhyde:

- . (A) parties internes recouvertes de Nobilitato couleur URBAN, parties externes mat/brillant laqué, bords ABS
- . (B) parties internes et externes de Nobilitato LEGNO, bords ABS
- . partie arrière en panneau MDF 3 mm Nobilitato URBAN

Holzpartikelplatte 16 oder 18 mm mit niedrigem Formaldehyd Gehalt:

- . (A) Innenteile mit Nobilitato URBAN-Farbe überzogen, Außenteile matt/glänzend lackiert, ABS-Kanten
- . (B) Innenteile und Außenteile aus Nobilitato LEGNO, ABS-Kanten
- . Hinterteil aus MDF Panel 3 mm Nobilitato URBAN



#### VANI A GIORNO / SHELVING UNITS / ÉLÉMENTS OUVERTS / REGALE

fianchi, tetto e fondo realizzati con pannelli di particelle di legno idrorepellenti spessore 10 o 18 mm a basso contenuto di formaldeide nelle seguenti conformazioni:

- . (A) laccati con vernici poliuretatiche in finitura opaco interno ed esterno od opaco interno e lucido esterno
- . (B) nobilitati con carta melaminica finitura LEGNO riprodotto ad alta fedeltà, sia interno che esterno; bordi in ABS in finitura
- . schienale prodotto con pannelli in particelle di legno idrorepellenti sp 18 mm in finitura Laccato OPACO (A) o Nobilitato con carta melaminica finitura LEGNO (B)

wood particles panels 10 or 18 mm with low formaldehyde content:

- . (A) matt lacquered internal and external parts or matt lacquered internal parts and glossy lacquered external parts
- . (B) internal and external parts covered with Nobilitato LEGNO, ABS edges
- . Matt lacquered back panel 18 mm (A) or Nobilitato LEGNO (B)

panneaux de particules de bois 10 ou 18 mm à faible teneur en formaldéhyde:

- . (A) parties internes recouvertes de Nobilitato couleur URBAN, parties externes mat/brillant laqué, bords ABS
- . (B) parties internes et externes de Nobilitato LEGNO, bords ABS
- . partie arrière mat laqué en panneau 18 mm (A) ou Nobilitato LEGNO (B)

Holzpartikelplatte 10 oder 18 mm mit niedrigem Formaldehyd Gehalt:

- . (A) Innenteile mit Nobilitato URBAN-Farbe überzogen, Außenteile matt/glänzend lackiert, ABS-Kanten
- . (B) Innenteile und Außenteile aus Nobilitato LEGNO, ABS-Kanten
- . matt lackiert Hinterteilpanel 18 mm (A) oder Nobilitato LEGNO (B)



PANNELLI TERMINALI / LATTER PANELS / PANNEAUX LATERAUX / SCHLISS PANEELE

. realizzati con pannelli di particelle di legno idrorepellenti spessore 10 / 18 mm a basso contenuto di formaldeide  
. previsti in finitura Laccato OPACO/LUCIDO o Nobilitato LEGNO

. wood particles panel 10 mm with low formaldehyde content  
. MATT/GLOSSY Lacquered or Nobilitato LEGNO

. panneaux de particules de bois 10 mm à faible teneur en formaldéhyde  
. MAT/BRILLANT Laqué ou Nobilitato LEGNO

. Holzpartikelplatte 10 mm mit niedrigem Formaldehyd Gehalt  
. MATT/GLÄNZEND Lackiert aus Nobilitato LEGNO



RIPIANI / SHELVES / ÉTAGÈRES / REGALE

i ripiani in vetro sono in posizione predefinita, il ripiano intermedio nelle colonne è realizzato con pannelli in particelle di legno idrorepellenti sp. 18 mm nobilitati con carta melaminica colore URBAN. In AUDACE i ripiani sono tutti in legno sp. 18 mm nobilitati con carta melaminica colore URBAN

inside the base cabinets the shelves, made of glass, are in a fixed position. In the wall cabinets and tall cabinets as well, but the shelf in the middle is made of Nobilitato LEGNO. For the AUDACE program the shelves are all in wood th. 18 mm ennobled with URBAN color melamine paper

les étagères en verre sont en position fixe, l'étagère au milieu des colonnes est en Nobilitato LEGNO. AUDACE a les étagères toutes en bois 18 mm ennobli de papier mélaminé couleur URBAN

in den Unterschränken sind die Regale in einer festen Position aus Glas. In den Wand-schränke das Regal in der Mitte ist aus Nobilitato LEGNO. Für das AUDACE-Programm sind die Regale alle aus Holz. 18 mm veredelt mit URBAN-Farbmelaminpapier



## dettagli costruttivi technical details

## détails de construction Konstruktionsdetails



### FISSAGGIO DELLE BASI / FIXING PARTS FOR UNITS / SUPPORTS DE MONTAGE POUR MEUBLES BAS / BEFESTIGUNGSTEILE

attaccaglie metalliche già predisposte sul retro, facile montaggio e regolazioni nelle tre dimensioni

adjustable metal brackets to be fixed to the wall, easy assembly and adjustments in three dimensions

supports métalliques réglables à fixer au mur, montage et réglages faciles en trois dimensions

verstellbare Metallstützen zur Befestigung an der Wand, einfache Montage und Einstellung in drei Dimensionen



### FISSAGGIO DI PENSILI COLONNE VANI A GIORNO / FIXING PARTS FOR WALL UNITS / SUPPORTS DE MONTAGE POUR MEUBLES HAUTS / BEFESTIGUNGSTEILE

attaccaglie metalliche predisposte sul retro. Facile montaggio e regolazioni nelle tre dimensioni

adjustable metal brackets to be fixed to the wall. Easy assembly and adjustments in three dimensions

supports métalliques réglables à fixer au mur. montage et réglages faciles en trois dimensions

verstellbare Metallstützen zur Befestigung an der Wand. einfache Montage und Einstellung in drei Dimensionen

dettagli costruttivi  
technical details

détails de construction  
Konstruktionsdetails



GUIDE GRASS®

cassetto montato su guide metalliche ad estrazione totale con chiusura ammortizzata e regolazione o con Sistema Premi-Apri

drawer fixed on full extension metal runners with soft-closing and adjustment

tiroir monté sur glissières métalliques à extension complète avec fermeture et réglage en douceur

Schublade montiert auf Vollauszug Metallschienen mit Dämpfung und Einstellung



CERNIERA

cerniera con apertura fino a 105° con chiusura rallentata, silenziosa e ammortizzata

soft-closing hinge, 105 degree, silent and cushioned slowed closure

charnière d'ouverture à 105 degrés avec fermeture ralentie, silencieuse et coussinée

105-Grad-Öffnungsscharnier mit geräuschlosem, gedämpftem Verschluss



ZOCCOLO

lo zoccolo in altezza 12 cm per i programmi LEALE e AUDACE è realizzato in coestruso di PVC resistente all'acqua e monta appositi ganci per il fissaggio ai piedini del mobile. Disponibile in finitura alluminio, laccato lucido/opaco nella cartella colori.02

the toe-kick is made of water-resistant PVC with hooks for fixing to the furniture. Available in alu finish, matt/glossy lacquered in the 48 colori.02

le socle est en PVC résistant à l'eau avec des crochets pour la fixation au meuble. Disponible en finition alu, laqué mat/brillant aux 48 colori.02

der Sockel besteht aus wasserfestem PVC mit Haken zur Befestigung am Möbel. Erhältlich in Alu-Finish, matt/glänzend lackiert in 48 colori.02





Il Colosseo è il più grande anfiteatro del mondo in grado di contenere fino a 80.000 unità e il più imponente monumento dell'antica Roma. Inserito nel 1980 nella lista dei patrimoni dell'umanità dall'UNESCO e nel 2007 tra le Nuove Sette Meraviglie del Mondo Moderno. Iniziato da Vespasiano nel 70 d.C. e inaugurato da Tito nell'80 d.C. l'edificio forma un'ellisse di 537 m di perimetro, con una superficie di 3.357 m<sup>2</sup>





Colosseo is the world biggest amphitheater that can welcome up to 80.000 units and it is the most massive monument of the ancient Rome. In 1980 it was added to the heritage of the humanity's list by UNESCO. In 2007 the Colosseo was included in the New Modern World's Seven Wonders. Starting with Vespasiano, in the 70 a.D., and inaugurated by Tito, in the 80 a.D., the edifice creates an ellipse with a diameter of 537 m with a surface of 3357 m<sup>2</sup>

**SISTEMA PER ARREDARE**  
CON LA RACCOLTA DEI PRODOTTI AROCK®

**UNICAMENTE AROCK®**  
DISSEMINATI NEL LISTINO PREZZI

FILOPIANO LAVABO INTEGRATO SOSPESO	ALCENTIMETRO
PIANO SOSPESO	ALCENTIMETRO
FILOPIANO LAVABO INTEGRATO PER MOBILI	ALCENTIMETRO
PIANO PER MOBILI	ALCENTIMETRO
PIANO PER BASI D'ARREDO	ALCENTIMETRO
LAVABO SOPRAPIANO DA APPOGGIO	
LAVABO SOPRAPIANO E SOTTOPIANO DA INCASSO	
SPECCHIO CON CORNICE	
PORTASALVIETTE	FREE-STANDING
COLONNINA	
POMOLO	PORTASALVIETTE
MENSOLA	NON ALCENTIMETRO
MENSOLA	CON PORTASALVIETTE - NON ALCENTIMETRO

**SISTEMA PER ARREDARE**  
CON I NOSTRI PRODOTTI IN QUARANTOTTO COLORI

**ALCENTIMETRO PROGETTO**  
E CON LE VOSTRE MISURE

PIANI SOSPESI	TUTTI
FILOPIANO LAVABO INTEGRATO SOSPESO	AROCK®
SHAMBOLA®	CONSOLE PER LAVABO
SHAMBOLA®	CONSOLE PER LAVABO CON TAVOLO
SHAMBOLA®	CONSOLE PER TAVOLO E TAVOLO DA INGRESSO
FILOPIANO LAVABI INTEGRATI PER MOBILI	
PIANI PER MOBILI	
PIANI PER BASI D'ARREDO	
SPECCHI LINEO E AERO	REVERSIBILI
MENSOLA	IN NOBILITATO E LACCATO OPACO/LUCIDO
PANCA	
BANCONE	
ZOCCOLO D'ARREDO H 3	

**ELEMENTI CONTENITORI**  
PER CREARE E COMPLETARE UN ARREDAMENTO

tutte le BASI D'ARREDO	
tutti i PENSILI CON ANTA SPECCHIATA	
tutti i PENSILI	
tutti i PENSILI A GIORNO	SOLO VERTICALI
tutte le COLONNE	
tutte le COLONNE A GIORNO	SOLO VERTICALI

**ELEMENTI COMPLEMENTARI**  
PER CREARE E COMPLETARE UN ARREDAMENTO

tutti i LAVABI	NON ALCENTIMETRO	PORTASALVIETTE	FREE-STANDING
tutti gli SPECCHI	NON ALCENTIMETRO	PORTASALVIETTE	A MURO
tutte le LAMPADE		MENSOLA	CON PORTASALVIETTE NON ALCENTIMETRO
		MENSOLA	NON ALCENTIMETRO
		COLONNINA	
VANI A GIORNO	SOLO ORIZZONTALI	POMOLO	PORTASALVIETTE IN AROCK®

**MOBILI DISEGNATI**

<b>SHAMBOLA®</b> di PAOLO SALVADÈ	<b>TALETE</b> di PAOLO SALVADÈ	<b>HAIKU</b> di T_FELDER
--------------------------------------	-----------------------------------	-----------------------------

**MOBILI COMPATTI**

<b>ONESTO</b>	<b>LIBERO</b>
---------------	---------------

**MOBILI COMPONENTI**

<b>LEALE</b>	<b>GIUSTO</b>
--------------	---------------

**MOBILI LAVANDERIA**

<b>AUDACE</b>
---------------







SISTEMA PER ARREDARE  
CON LA RACCOLTA DEI PRODOTTI AROCK®

UNICAMENTE

AROCK®

DISSEMINATI NEL LISTINO PREZZI

FILOPIANO LAVABO INTEGRATO SOSPESO ALCENTIMETRO

PIANO SOSPESO ALCENTIMETRO

FILOPIANO LAVABO INTEGRATO PER MOBILI ALCENTIMETRO

PIANO PER MOBILI ALCENTIMETRO

PIANO PER BASI D'ARREDO ALCENTIMETRO

LAVABO SOPRAPIANO DA APPOGGIO

LAVABO SOPRAPIANO E SOTTOPIANO DA INCASSO

SPECCHIO CON CORNICE

PORTASALVIETTE FREE-STANDING

COLONNINA

POMOLO

MENSOLA NON ALCENTIMETRO

MENSOLA CON PORTASALVIETTE - NON ALCENTIMETRO

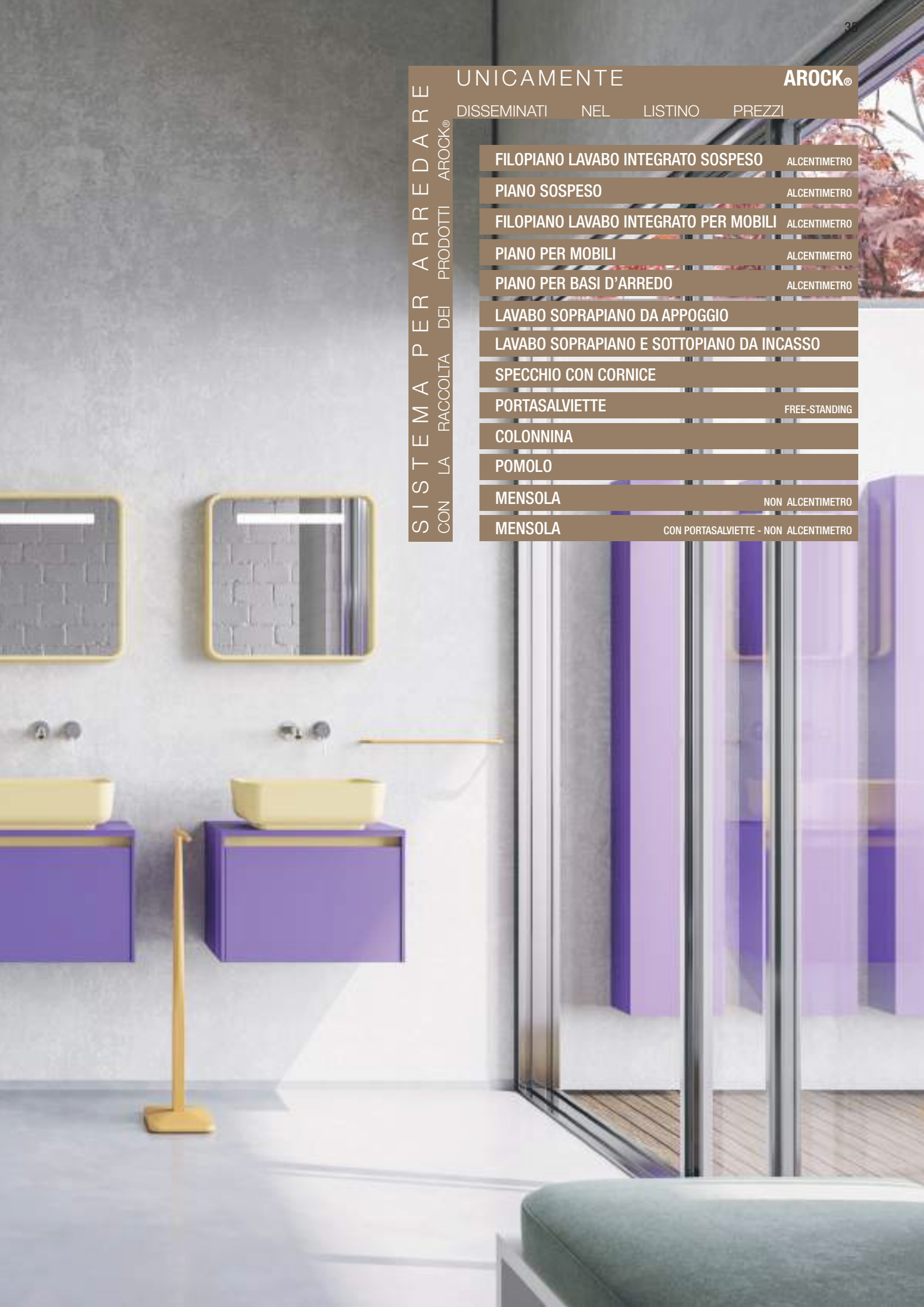

AROCK® È UN MATERIALE RICCO DI PURISSIMA ROCCIA CALCAREA ITALIANA UNITO A RESINE POLIESTERE E RIFINITO CON UNA SUPERFICIE IN GELCOAT COLORATO. IDROREPELENTE, ANTIBATTERICO E RESISTENTE, ACCOMPAGNA GLI ARREDI DI TDA IN TUTTI GLI AMBIENTI DELLA CASA.

A  
R  
O  
C  
K  
®



AROCK® IS A RICH MATERIAL MADE OF PURE ITALIAN LIMESTONE ROCK MELT WITH POLYESTER RESINS. IT IS REFINED WITH A COLORED GELCOAT SURFACE. IT IS AN HYDROPHOBIC, ANTIBACTERIAL, AND RESISTANT MATERIAL, WHICH GOES WITH TDA'S BATHROOM AND LIVING FURNITURE.



FILOPIANO LAVABO INTEGRATO **SOSPESO** ALCENTIMETRO

PIANO **SOSPESO** ALCENTIMETRO

### lavabo / basin / vasque / Becken



lavabo integrato  
integrated basin  
vasque intégrée  
integriertes Becken

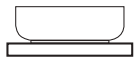

soprapiano da appoggio  
countertop basin  
lavabo à poser  
Aufsatzwaschtisch

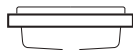

soprapiano da incasso  
recessed basin  
lavabo encastré surélevé  
Halbeinbaubecken

		P 45 / 51,5 cm		
<p>filopiano lavabo integrato sospeso wall-mounted integrated top basin plan suspendu pour les lavabos aufgehängte Platte fuer die Waschbecken</p> <p><b>H 6 / 10 / 15 cm</b></p>			<p>48 colori.02</p>	
<p>piano sospeso wall counter top plan suspendu pour l'ameublement aufgehängte Platte fuer Einrichtung</p> <p><b>H 6 / 10 / 15 cm</b></p>				
<p>piano sospeso per lavabo soprapiano da appoggio wall counter-mounted counter top basin plan suspendu pour les lavabos aufgehängte Platte fuer die Waschbecken</p> <p><b>H 6 / 10 / 15 cm</b></p>				
<p>piano sospeso per lavabo soprapiano da incasso wall counter-mounted counter top basin plan suspendu pour les lavabos encastré aufgehängte Platte für Halbeinbaubecken</p> <p><b>H 10 / 15</b></p>				

**come calcolare il prezzo**  
**how to calculate the price**

**comment calculer le prix**  
**wie berechnet man den Preis**

1. scegliere la tipologia di lavabo desiderato  
choose your type of basin  
choisissez le type de lavabo que vous préférez  
wählen Sie den gewünschten Becken
2. verificare la profondità necessaria del piano sospeso, per l'installazione del lavabo scelto  
check the depth of the free-standing top needed to install your basin  
vérifier la profondeur du plan suspendu nécessaire pour installer le lavabo choisi  
überprüfen Sie die Tiefe der Freistehndeplatte, der für die Installation der Becken erforderlich ist
3. stabilire la lunghezza del piano sospeso  
decide the length of the free-standing top  
établir la longueur du plan suspendu  
stellen Sie das Material und die Länge der Freistehndeplatte fest
4. calcolare il prezzo totale usando la tabella al cm lineare del piano sospeso scelto  
calculate the total price using the cost per cm of the chosen free-standing top  
calculer le prix total en utilisant le cout linéaire par cm du plan suspendu choisi  
berechnen Sie den Gesamtpreis anhand der linearen Kosten in cm des gewählten Freistehndeplatte
5. aggiungere il prezzo di eventuali variabili in tabella  
add the price of any variables to be found in the table  
ajouter le prix des variables dans le tableau  
addieren Sie den Preis aller Variablen in der Tabelle
6. aggiungere il prezzo del numero di staffe secondo la lunghezza del piano sospeso  
add the price of the brackets according to the length of the free-standing top  
ajouter le prix du nombre de supports en fonction de la longueur du plan suspendu  
addieren Sie den Preis fuer die Wandhalterungen

**attenzione - note**  
**attention - notes**

**attention - notes**  
**achtung - Notizen**

- i fori per la rubinetteria NON prevedono sovrapprezzo  
NO extra costs for tap holes  
PAS frais supplémentaires pour les trous de robinetterie  
KEINE zusätzlichen Kosten fuer Waschenbeckenlöcher
- i piani di misura inferiore alla L minima indicata, NON sono realizzabili  
NO smaller size than the one indicated for the top  
PAS la mesure inférieure au minimum indiqué pour plan  
KEIN Plan niedriger als das angegebene Minimum
- le lavorazioni a smusso e per i cambi di profondità NON sono ammesse  
NO bevel cuts and depth changing  
PAS change de la profondeur et coupe en biseau  
KEIN abgeschrägter Schnitt und Änderung der Tiefe
- i piani con dima e/o disegno tecnico, hanno un sovrapprezzo di **300 €**  
**300 €** extra cost for tops with template or technical drawing  
extra cost for tops with template or technical drawing **300 €**  
Platte mit Vorlage oder technischer Zeichnung haben einen Aufpreis von **300 €**
- la scheda tecnica di un lavabo non presente nel nostro listino è indispensabile per la produzione del piano  
the technical data sheet of a washbasin, which is not indicated in our price list, is essential for the production of the top  
la fiche technique d'une vasque non présente dans notre tarif est indispensable pour la réalisation du plan  
das technische Datenblatt eines Becken, das nicht in unserer Preisliste enthalten ist, ist für die Herstellung des Tops zwingend erforderlich



FILOPIANO LAVABO INTEGRATO SOSPEO AROCK®







**AROCK®**

Filopiano lavabo integrato  
 Integrated plan washbasin  
 Vasque en plan intégrée  
 Integrierte Waschtischplatte

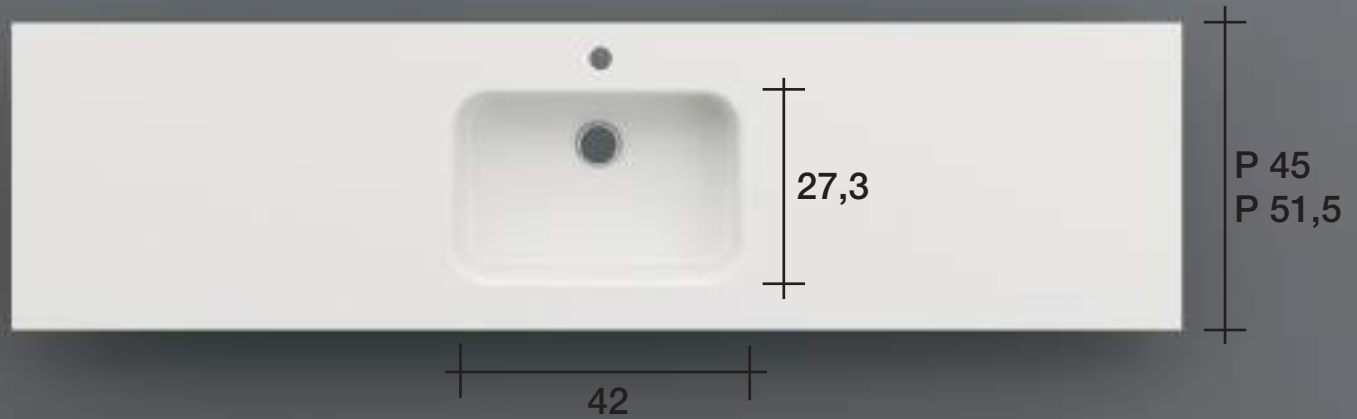
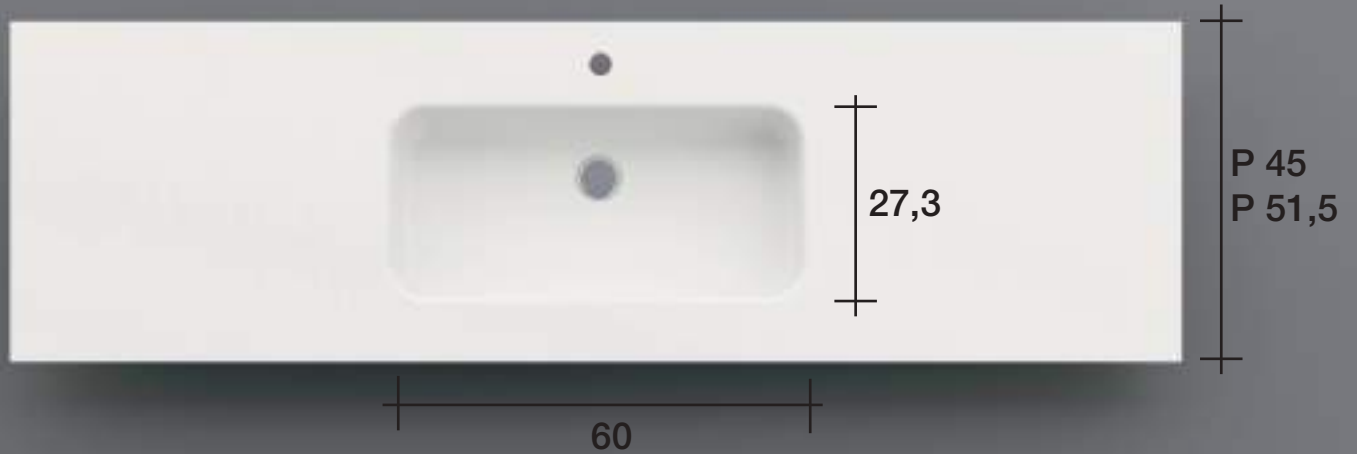

foro rubinetto incl.  
 tap hole incl.  
 trou pour le robinet incl.  
 Armaturbohrung inkl.

non provisto di scarico troppopieno  
 without overflow system  
 sans système de trop-plein  
 ohne Überlaufsystem

kit piletta e sifone da ordinare separatamente  
 waste kit and siphon to be ordered separately  
 kit bonde d'évacuation et siphon à commander séparément  
 Ablauf Kit und Siphon müssen separat bestellt werden

AROCK®



H 6 / 10 / 15 cm - L max 210 cm

piano sospeso min L 60 cm - vasca L 42  
 piano sospeso min L 80 cm - vasca L 60

wall counter top min W 60 cm - integrated basin W 42  
 wall counter top min W 80 cm - integrated basin W 60

plan suspendu pour l'ameublement min L 60 cm - vasque L 42  
 plan suspendu pour l'ameublement min L 80 cm - vasque L 60

aufgehängte Platte fuer Einrichtung min B 60 cm - Becken B 42  
 aufgehängte Platte fuer Einrichtung min B 80 cm - Becken B 60

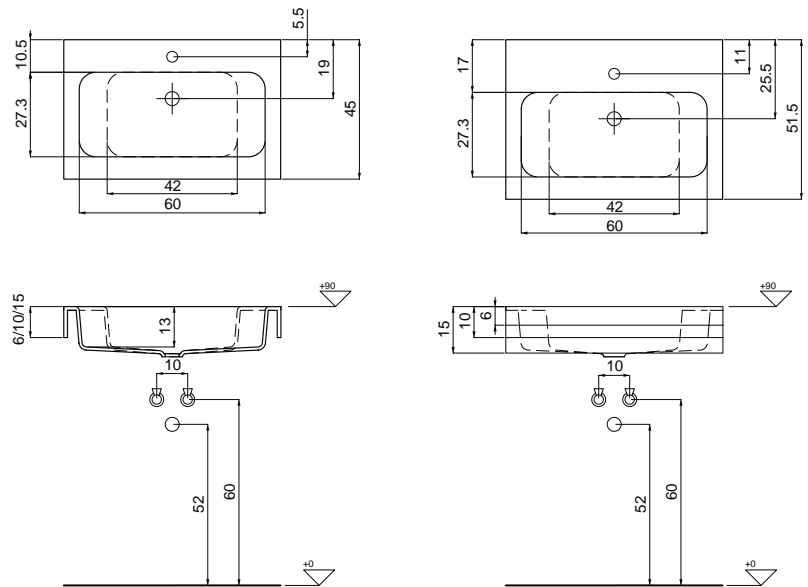



Per calcolare il prezzo totale del piano sospeso sommare al prezzo dei primi 50 cm il prezzo dei centimetri restanti

To calculate the total price of the wall counter top, add the price of the remaining cm to the price of the first 50 cm

Pour calculer le prix total de le plan suspendu pour l'ameublement, ajouter le prix du cm restant au prix des 50 premiers cm

Um den Gesamtpreis für den aufgehängte Platte fuer Einrichtung, addieren Sie den Preis für die verbleibenden cm zum Preis für die ersten 50 cm

cod.	P	H	< 50 cm		
			vasca incl. nel prezzo basin price incl. prix du lavabo incl. Preis des Becken inkl.		prezzo seconda vasca additional basin price prix du lavabo supplémentaire Preis für das zusätzliche Becken
P5HI4506	45	6			
P5HI5106	51,5	6			
P5HI4510	45	10			
P5HI5110	51,5	10			
P5HI4515	45	15			
P5HI5115	51,5	15			
				al cm lineare per linear cm au cm linéaire pro cm	

Staffa di sostegno - ordinare separatamente  
 Brackets - order separately  
 Supports - commander séparément  
 Wandhalterungen - Separat bestellen

cod. **OMZSTA06**

**52 €** un pezzo  
 each piece  
 une pièce  
 einzelne Stück

< L 90 - 2 pz  
 L 91 ÷ 130 - 3 pz  
 L 131 ÷ 180 - 4 pz  
 L 181 ÷ 210 - 5 pz

**AROCK®**

Filopiano lavabo integrato  
Integrated plan washbasin  
Vasque en plan intégrée  
Integrierte Waschtischplatte

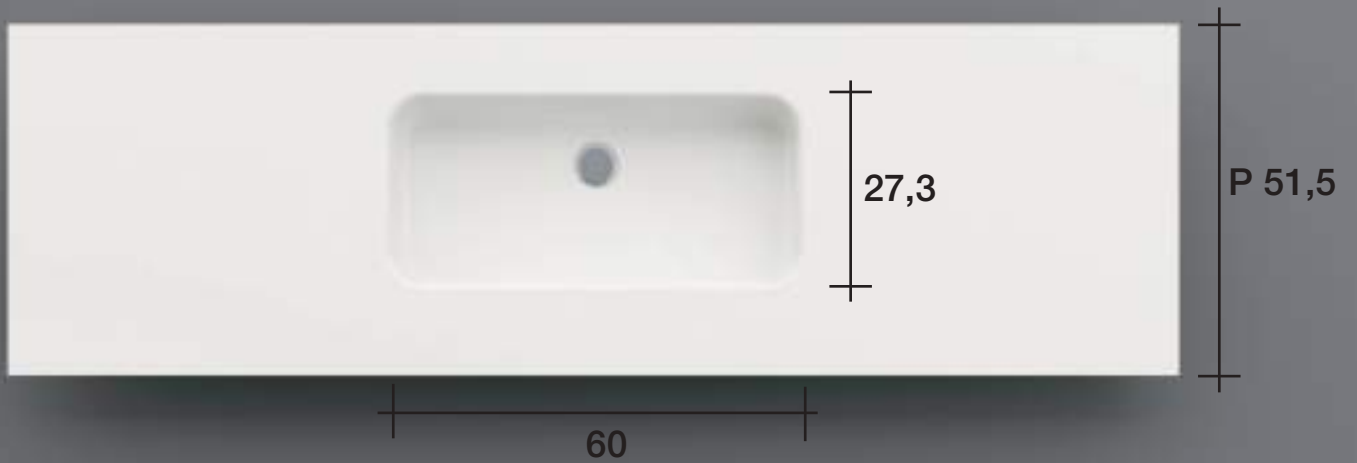

non provvisto di scarico troppopieno  
without overflow system  
sans système de trop-plein  
ohne Überlaufsystem

kit piletta e sifone da ordinare separatamente  
waste kit and siphon to be ordered separately  
kit bonde d'évacuation et siphon à commander séparément  
Ablauf Kit und Siphon müssen separat bestellt werden

AROCK®



H 6 / 10 / 15 cm - L max 210 cm

piano sospeso min L 60 cm - vasca L 42  
 piano sospeso min L 80 cm - vasca L 60

wall counter top min W 60 cm - integrated basin W 42  
 wall counter top min W 80 cm - integrated basin W 60

plan suspendu pour l'ameublement min L 60 cm - vasque L 42  
 plan suspendu pour l'ameublement min L 80 cm - vasque L 60

aufgehängte Platte fuer Einrichtung min B 60 cm - Becken B 42  
 aufgehängte Platte fuer Einrichtung min B 80 cm - Becken B 60

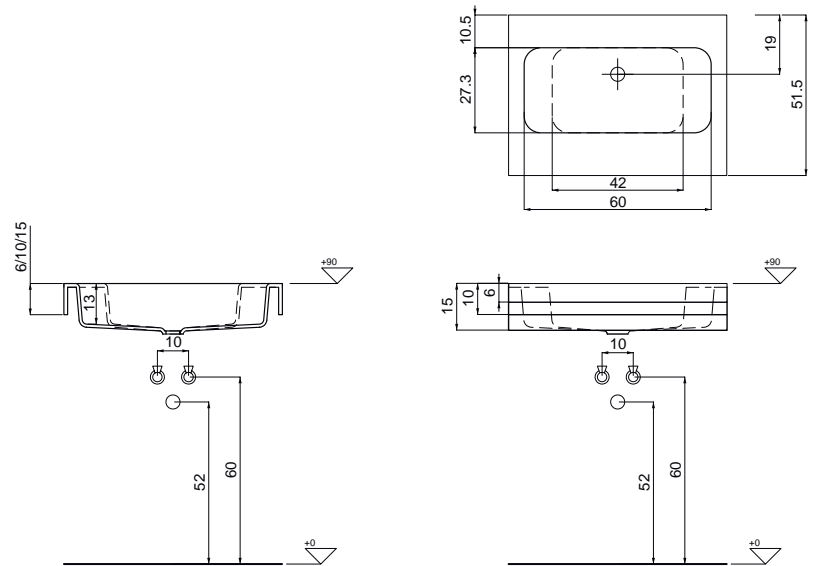



Per calcolare il prezzo totale del piano sospeso sommare al prezzo dei primi 50 cm il prezzo dei centimetri restanti

To calculate the total price of the wall counter top, add the price of the remaining cm to the price of the first 50 cm

Pour calculer le prix total de le plan suspendu pour l'ameublement, ajouter le prix du cm restant au prix des 50 premiers cm

Um den Gesamtpreis für den aufgehängte Platte fuer Einrichtung, addieren Sie den Preis für die verbleibenden cm zum Preis für die ersten 50 cm

cod.	P	H	< 50 cm		
			vasca incl. nel prezzo basin price incl. prix du lavabo incl. Preis des Becken inkl.		prezzo seconda vasca additional basin price prix du lavabo supplémentaire Preis für das zusätzliche Becken
PSHV5106	51,5	6			
PSHV5110	51,5	10			
PSHV5115	51,5	15			
				al cm lineare per linear cm au cm linéaire pro cm	

Staffa di sostegno - ordinare separatamente  
 Brackets - order separately  
 Supports - commander séparément  
 Wandhalterungen - Separat bestellen

cod. **OMZSTA06**

**52 €** un pezzo  
 each piece  
 une pièce  
 einzelne Stück

< L 90 - 2 pz  
 L 91 ÷ 130 - 3 pz  
 L 131 ÷ 180 - 4 pz  
 L 181 ÷ 210 - 5 pz



PIANO SOSPEO AROCK®





AROCK®



Per calcolare il prezzo totale del piano sospeso sommare al prezzo dei primi 50 cm il prezzo dei centimetri restanti  
 To calculate the total price of the wall counter top, add the price of the remaining cm to the price of the first 50 cm  
 Pour calculer le prix total de le plan suspendu pour l'ameublement, ajouter le prix du cm restant au prix des 50 premiers cm  
 Um den Gesamtpreis für den aufgehängte Platte fuer Einrichtung, addieren Sie den Preis für die verbleibenden cm zum Preis für die ersten 50 cm

cod.	P	H	< 50 cm	al cm lineare per linear cm au cm linéaire pro cm	+ prezzo foro lavabo + washbasin hole price + prix du trou pour vasque + Preis für Waschbeckenloch	
PSHA4506	45	6				
PSHA5106	51,5	6				
PSHL4506	45	6				
PSHL5106	51,5	6				
PSHA4510	45	10				
PSHA5110	51,5	10				
PSHL4510	45	10				
PSHL5110	51,5	10				
PSHA4515	45	15				
PSHA5115	51,5	15				
PSHL4515	45	15				
PSHL5115	51,5	15				

Staffa di sostegno - ordinare separatamente  
 Brackets - order separately  
 Supports - commander séparément  
 Wandhalterungen - Separat bestellen

cod. **OMZSTA06**

**52 €** un pezzo  
 each piece  
 une pièce  
 einzelne Stück

< L 90 - 2 pz  
 L 91 ÷ 130 - 3 pz  
 L 131 ÷ 180 - 4 pz  
 L 181 ÷ 210 - 5 pz

FILOPIANO LAVABO INTEGRATO PER MOBILI ALCENTIMETRO

PIANO PER MOBILI ALCENTIMETRO

PIANO PER BASI D'ARREDO

ALCENTIMETRO

### lavabo / basin / vasque / Becken



lavabo integrato  
integrated basin  
vasque intégrée  
integriertes Becken

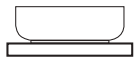





soprapiano da appoggio  
countertop basin  
lavabo à poser  
Aufsetzbecken



soprapiano da incasso  
recessed basin  
lavabo encastré surélevé  
Halbeinbaubecken

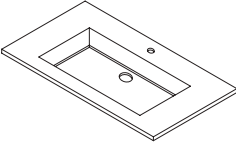
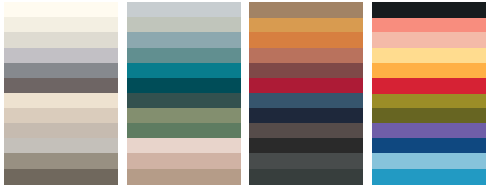
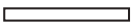
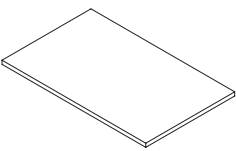
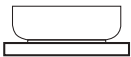
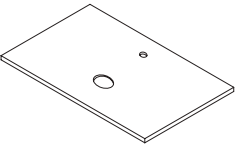

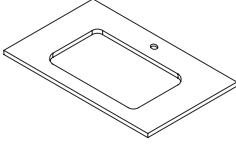
sottopiano da incasso  
undermounted basin  
lavabo en profondeur  
Unteneinbaubecken

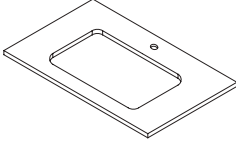
<p>filopiano lavabo integrato integrated top basin plan pour meubles avec vasque intégrée Abdeckplatten für Waschbeckenunterschranke</p>			<p>48 colori.02</p> 
<p>piano per mobili e per basi d'arredo tops for units plans pour meubles Abdeckplatten für Unterschranke</p>			
<p>piano per lavabo soprapiano da appoggio counter top basin plan pour lavabo à poser Abdeckplatten für Aufsetzbecken</p>			
<p>piano per lavabo soprapiano da incasso counter top recessed basin plan pour lavabo à encastré surélevé Abdeckplatten für Halbeinbaubecken</p>			
<p>piano per lavabo sottopiano da incasso counter top undermounted basin plan pour lavabo en profondeur Abdeckplatten für Unteneinbaubecken</p>			

**come calcolare il prezzo di un piano o piano d'arredo**  
**how to calculate the price of a top**

**comment calculer le prix d'un plain**  
**wie berechnet man den Preis einer Platte**

1. scegliere la tipologia di lavabo desiderato  
 choose your type of basin  
 choisissez le type de lavabo que vous préférez  
 wählen Sie den gewünschten Becken
2. verificare la profondità necessaria del piano per l'installazione del lavabo scelto  
 check the depth of the top needed to install your basin  
 vérifier la profondeur du plan nécessaire pour installer le lavabo choisi  
 überprüfen Sie die Tiefe der Platte, der für die Installation der Becken erforderlich ist
3. stabilire la lunghezza del piano  
 decide material and length of the top  
 établir le matériau et la longueur du plan  
 stellen Sie das Material und die Länge der Platte fest
4. calcolare il prezzo totale usando la tabella al cm lineare del piano scelto  
 calculate the total price using the cost per cm of the chosen top  
 calculer le prix total en utilisant le cout linéaire par cm du plan choisi  
 berechnen Sie den Gesamtpreis anhand der linearen Kosten in cm des gewählten Plans
5. aggiungere il prezzo di eventuali variabili in tabella  
 add the price of any variables to be found in the table  
 ajouter le prix des variables dans le tableau  
 addieren Sie den Preis aller Variablen in der Tabelle

**attenzione - note**  
**attention - notes**

**attention - notes**  
**achtung - Notizen**

- i fori per la rubinetteria NON prevedono sovrapprezzo  
 NO extra costs for tap holes  
 PAS frais supplémentaires pour les trous de robinetterie  
 KEINE zusätzlichen Kosten fuer Waschenbeckenlöcher
- i piani di misura inferiore alla L minima indicata, NON sono realizzabili  
 NO smaller size than the one indicated for the top  
 PAS la mesure inférieure au minimum indiqué pour plan  
 KEIN Plan niedriger als das angegebene Minimum
- per le lavorazioni a smusso e per i cambi di profondità, inviare sempre la richiesta all'ufficio tecnico TDA  
 for bevel cuts and depth changing please contact TDA technical office  
 pour changement de profondeur et coupe en biseau, contacter le bureau technique TDA  
 für abgeschrägter Schnitt und Änderung der Tiefe, wenden Sie sich an das technische Büro von TDA
- i piani con dima e/o disegno tecnico, hanno un sovrapprezzo di **300 €**  
**300 €** extra cost for tops with template or technical drawing  
 extra cost for tops with template or technical drawing **300 €**  
 Platte mit Vorlage oder technischer Zeichnung haben einen Aufpreis von **300 €**
- la scheda tecnica di un lavabo non presente nel nostro listino è indispensabile per la produzione del piano  
 the technical data sheet of a washbasin not indicated in our price list is essential for the production of the top  
 la fiche technique d'une vasque non présente dans notre tarif est indispensable pour la réalisation du plan  
 das technische Datenblatt eines Becken, das nicht in unserer Preisliste enthalten ist, ist für die Herstellung des Tops zwingend erforderlich

FILOPIANO LAVABO INTEGRATO AROCK®

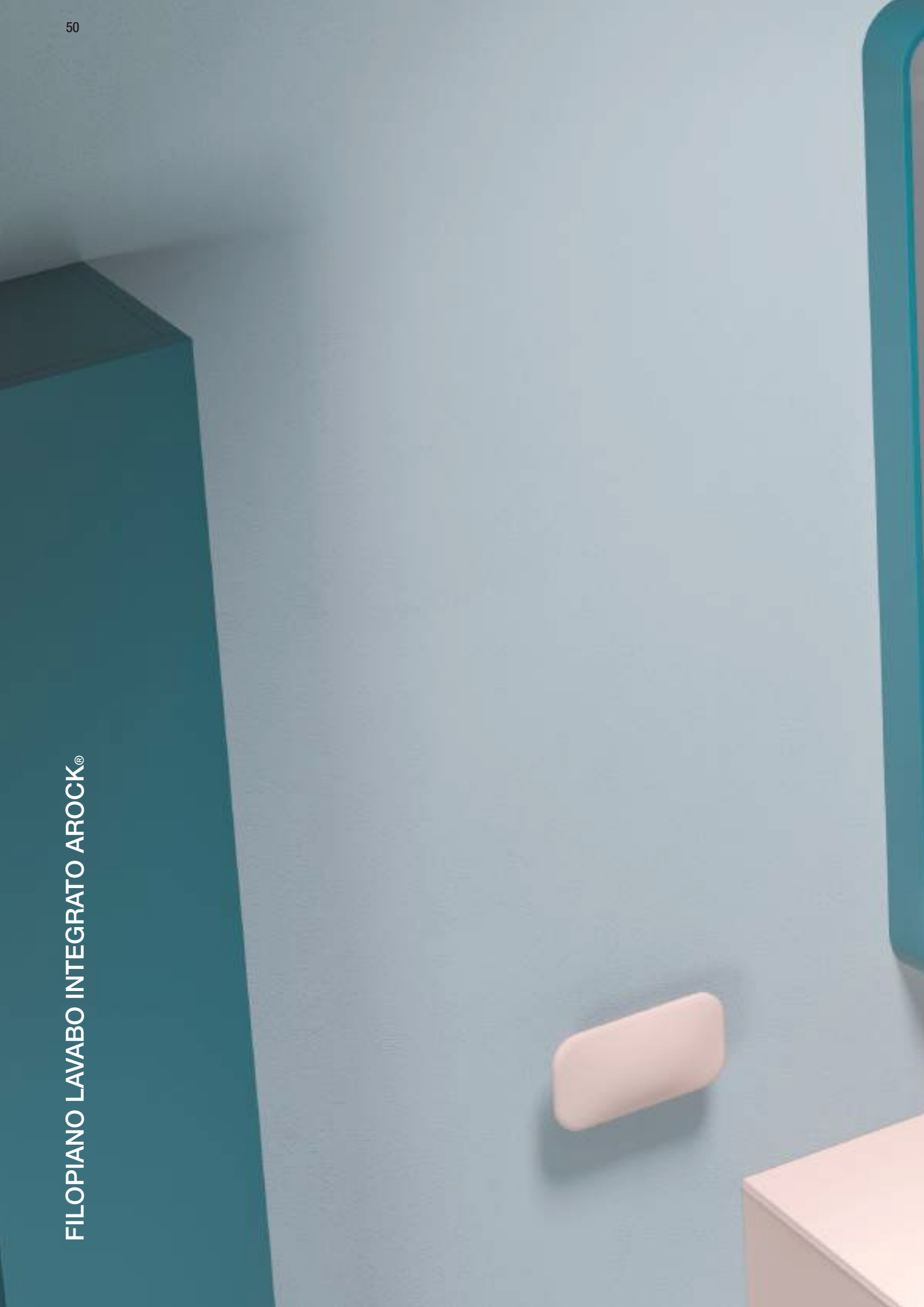

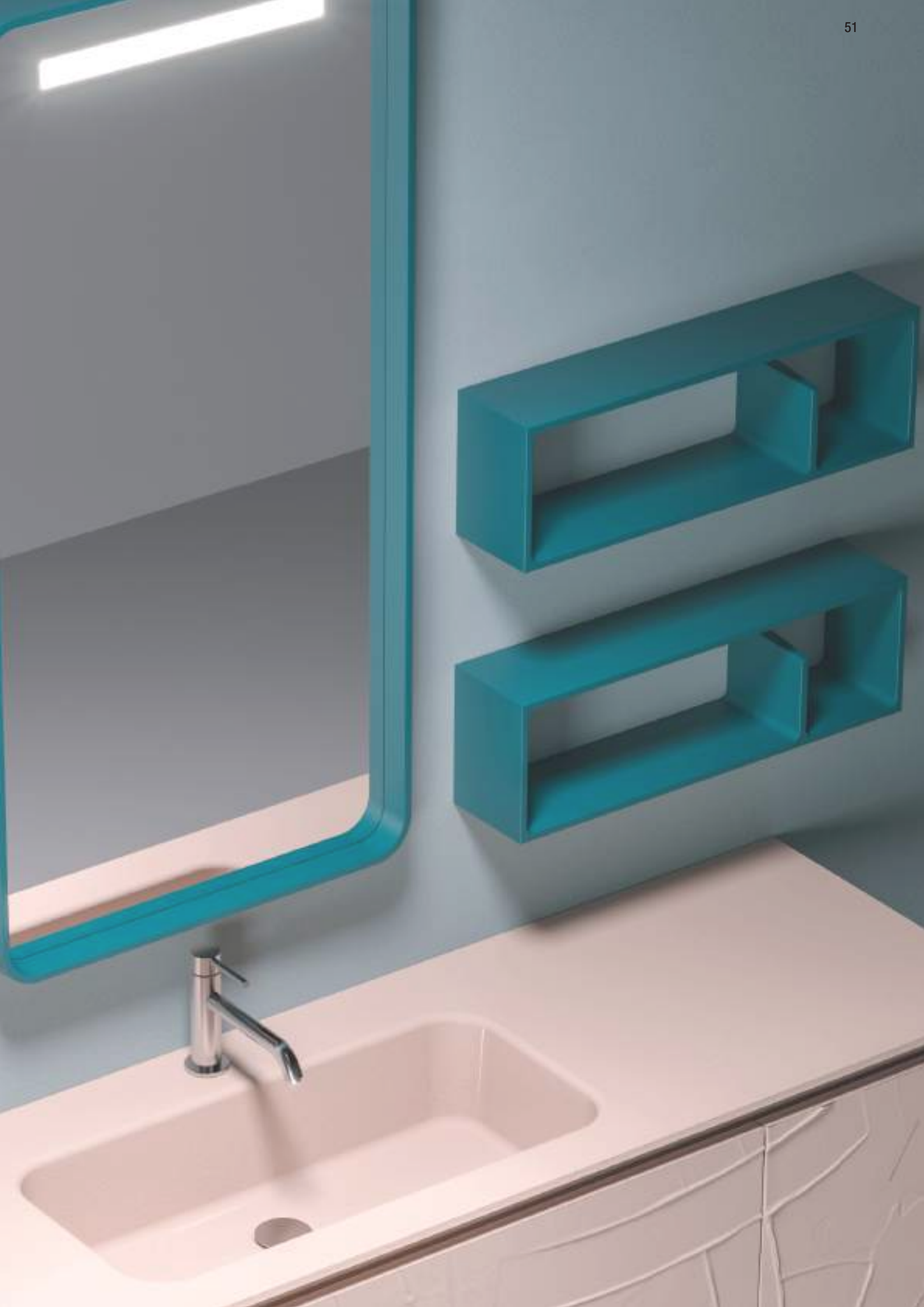



**AROCK®**

Filopiano lavabo integrato  
 Integrated plan washbasin  
 Vasque en plan intégrée  
 Integrierte Waschtischplatte

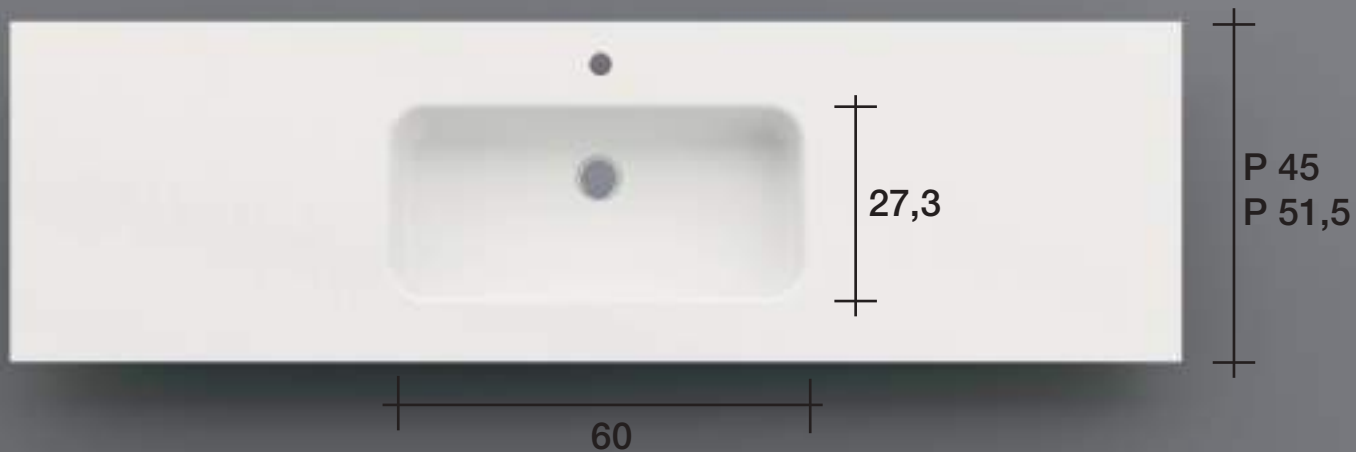

foro rubinetto incl.  
 tap hole incl.  
 trou pour le robinet incl.  
 Armaturbohrung inkl.

non provisto di scarico troppopieno  
 without overflow system  
 sans système de trop-plein  
 ohne Überlaufsystem

kit piletta e sifone da ordinare separatamente  
 waste kit and siphon to be ordered separately  
 kit bonde d'évacuation et siphon à commander séparément  
 Ablauf Kit und Siphon müssen separat bestellt werden

AROCK®



H 1,2 cm - L max 210 cm



H 6 cm - L max 210 cm

su basi portalavabo min L 54 cm - vasca L 42  
 su basi portalavabo min L 70 cm - vasca L 60

washbasin unit min W 54 cm - integrated basin W 42  
 washbasin unit min W 70 cm - integrated basin W 60

meuble sous-vasque min L 54 cm - vasque L 42  
 meuble sous-vasque min L 70 cm - vasque L 60

Waschtischunterschrank min B 54 cm - Becken B 42  
 Waschtischunterschrank min B 70 cm - Becken B 60

Per calcolare il prezzo totale del piano sospeso sommare al prezzo dei primi 50 cm il prezzo dei centimetri restanti

To calculate the total price of the wall counter top, add the price of the remaining cm to the price of the first 50 cm

Pour calculer le prix total de le plan suspendu pour l'ameublement, ajouter le prix du cm restant au prix des 50 premiers cm

Um den Gesamtpreis für den aufgehängte Platte fuer Einrichtung, addieren Sie den Preis für die verbleibenden cm zum Preis für die ersten 50 cm

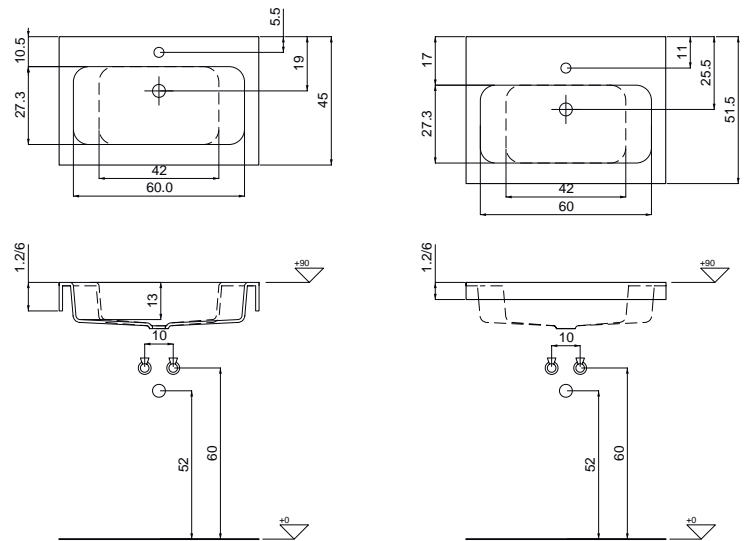

cod.	P	H	< 50 cm				
			vasca incl. nel prezzo basin price incl. prix du lavabo incl. Preis des Becken inkl.		prezzo seconda vasca additional basin price prix du lavabo supplémentaire Preis für das zusätzliche Becken		
PSHI45IN	45	1,2					
PSHI51IN	51,5	1,2					
PSHI4506	45	6					
PSHI5106	51,5	6					
				al cm lineare per linear cm au cm linéaire pro cm			

Alzata / Wall top / Plan au mur / Platte an die Wand

cod.	sp.	H	al cm lineare / per linear cm / au cm linéaire / pro cm
PSH015AL	1,2	5 ÷ 15	
PSH040AL	1,2	16 ÷ 40	

**AROCK®**

Filopiano lavabo integrato  
Integrated plan washbasin  
Vasque en plan intégrée  
Integrierte Waschtischplatte

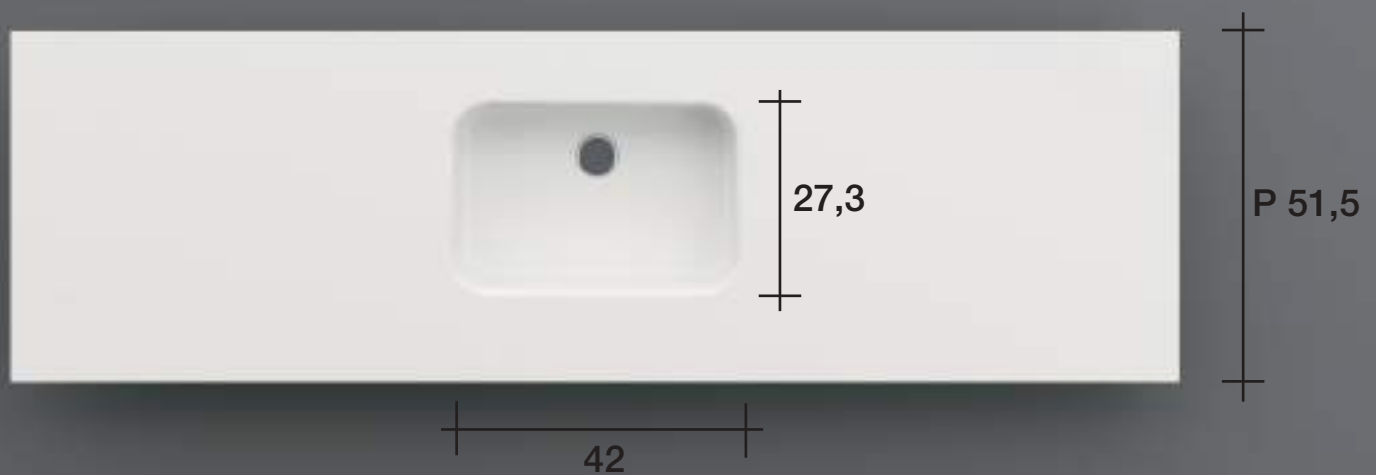
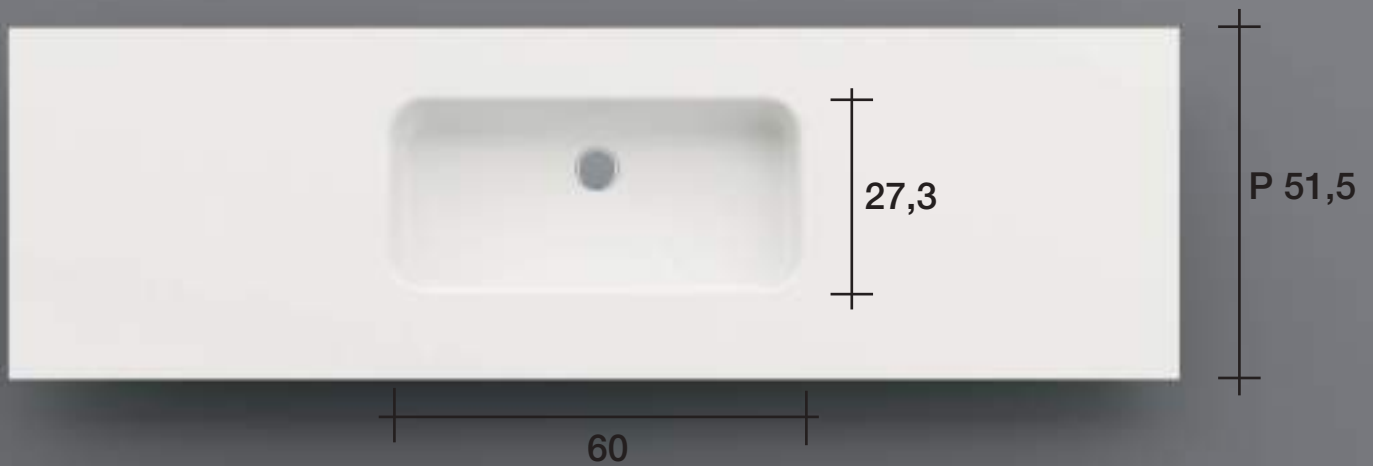

non provvisto di scarico troppopieno  
without overflow system  
sans système de trop-plein  
ohne Überlaufsystem

kit piletta e sifone da ordinare separatamente  
waste kit and siphon to be ordered separately  
kit bonde d'évacuation et siphon à commander séparément  
Ablauf Kit und Siphon müssen separat bestellt werden

AROCK®



H 1,2 cm - L max 210 cm



H 6 cm - L max 210 cm

su basi portalavabo min L 54 cm - vasca L 42

su basi portalavabo min L 70 cm - vasca L 60

washbasin unit min W 54 cm - integrated basin W 42

washbasin unit min W 70 cm - integrated basin W 60

meuble sous-vasque min L 54 cm - vasque L 42

meuble sous-vasque min L 70 cm - vasque L 60

Waschtischunterschrank min B 54 cm - Becken B 42

Waschtischunterschrank min B 70 cm - Becken B 60

Per calcolare il prezzo totale del piano sospeso sommare al prezzo dei primi 50 cm il prezzo dei centimetri restanti

To calculate the total price of the wall counter top, add the price of the remaining cm to the price of the first 50 cm

Pour calculer le prix total de le plan suspendu pour l'ameublement, ajouter le prix du cm restant au prix des 50 premiers cm

Um den Gesamtpreis für den aufgehängte Platte fuer Einrichtung, addieren Sie den Preis für die verbleibenden cm zum Preis für die ersten 50 cm

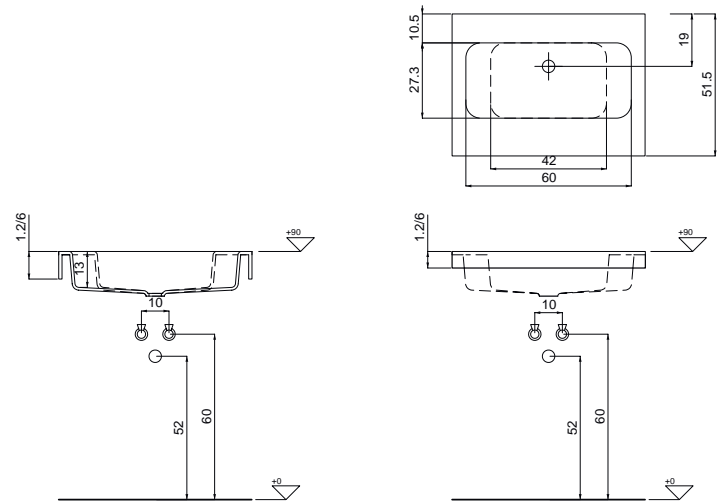

cod.	P	H	< 50 cm			
			vasca incl. nel prezzo basin price incl. prix du lavabo incl. Preis des Becken inkl.		prezzo seconda vasca additional basin price prix du lavabo supplémentaire Preis für das zusätzliche Becken	
PSHV51IN	51,5	1,2				
PSHV5106	51,5	6		al cm lineare per linear cm au cm linéaire pro cm		

Alzata / Wall top / Plan au mur / Platte an die Wand

cod.	sp.	H	al cm lineare / per linear cm / au cm linéaire / pro cm
PSH015AL	1,2	5 ÷ 15	
PSH040AL	1,2	16 ÷ 40	



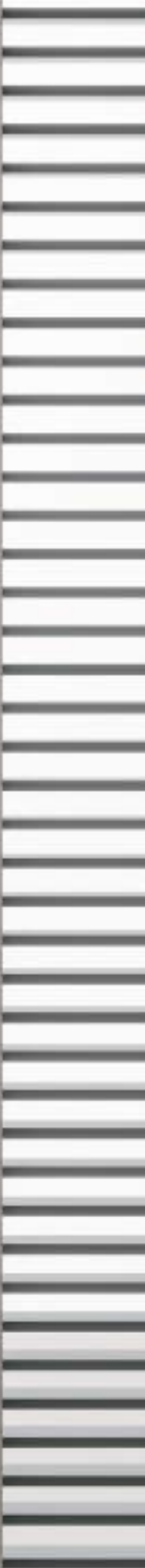

PIANO PER MOBILI AROCK®

PIANO PER MOBILI

ALCENTIMETRO

PIANO PER BASI D'ARREDO

AROCK®



Per calcolare il prezzo totale del piano sommare al prezzo dei primi 50 cm il prezzo dei centimetri restanti

To calculate the total price of the top, add the price of the remaining cm to the price of the first 50 cm

Pour calculer le prix total de le plan, ajouter le prix du cm restant au prix des 50 premiers cm

Um den Gesamtpreis für den Platte zu berechnen, addieren Sie den Preis für die verbleibenden cm zum Preis für die ersten 50 cm

cod.	P	H	< 50 cm	al cm lineare per linear cm au cm linéaire pro cm		+ prezzo foro lavabo + washbasin hole price + prix du trou pour vasque + Preis für Waschbeckenloch	
PSHA18PA	18	1,2					
PSHA35PA	34	1,2					
PSHA37PA	37	1,2					
PSHA43PA	43,5	1,2					
PSHA45PA	45	1,2					
PSHA51PA	51,5	1,2					
PSHA4506	45	6					
PSHA5106	51,5	6					
PSHA4510	45	10					
PSHA5110	51,5	10					
PSHA4515	45	15					
PSHA5115	51,5	15					
PSHL45AP	45	1,2					
PSHL51AP	51,5	1,2					
PSHL54AP	54	1,2					

Alzata / Wall top / Plan au mur / Platte an die Wand

cod.	sp.	H	al cm lineare / per linear cm / au cm linéaire / pro cm
PSH015AL	1,2	5 ÷ 15	3,0 €
PSH040AL	1,2	16 ÷ 40	3,0 €

## LAVABO SOPRAPIANO DA APPOGGIO AROCK®





**RUBIZIO**

Lavabo sopra piano da appoggio in Arock®  
 Arock® countertop basin  
 Lavabo à poser en Arock®  
 Aufsatzbecken aus Arock®

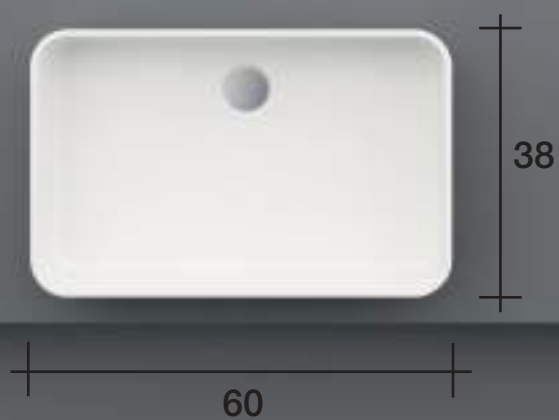
**GGKL6002****GNIFFO**

Lavabo sopra piano da appoggio in Arock®  
 Arock® countertop basin  
 Lavabo à poser en Arock®  
 Aufsatzbecken aus Arock®

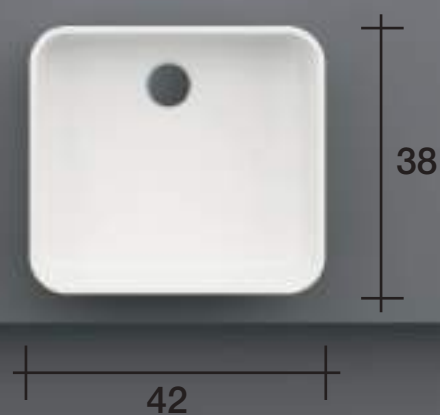
**GGKL4202**

non provvisto di scarico troppopieno  
 without overflow system  
 sans système de trop-plein  
 ohne Überlaufsystem

kit piletta e sifone da ordinare separatamente  
 waste kit and siphon to be ordered separately  
 kit bonde d'évacuation et siphon à commander séparément  
 Ablauf Kit und Siphon müssen separat bestellt werden

non provvisto di scarico troppopieno  
 without overflow system  
 sans système de trop-plein  
 ohne Überlaufsystem

kit piletta e sifone da ordinare separatamente  
 waste kit and siphon to be ordered separately  
 kit bonde d'évacuation et siphon à commander séparément  
 Ablauf Kit und Siphon müssen separat bestellt werden



AROCK®

## RUBIZIO



su basi portalavabo min L 60 cm  
 washbasin unit min W 60 cm  
 meuble sous-vasque min L 60 cm  
 Waschtischunterschrank min B 60

piano sospeso min L 60 cm  
 wall counter top min W 60 cm  
 plan suspendu pour l'ameublement min L 60 cm  
 aufgehängte Platte fuer Einrichtung min B 60 cm

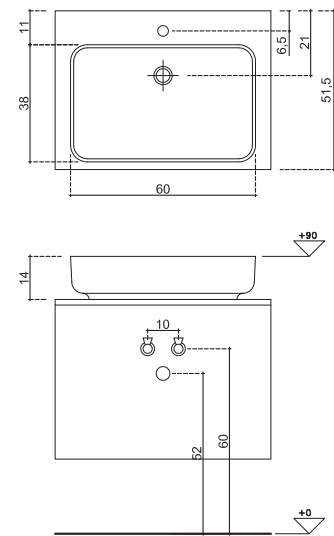
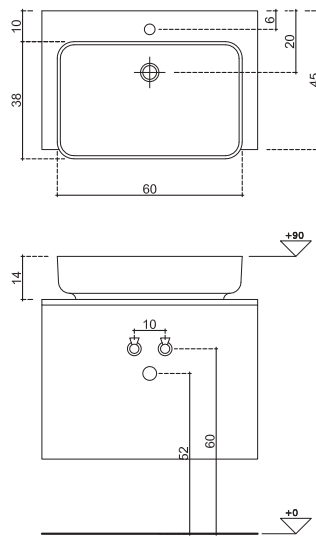

## GNIFFO



su basi portalavabo min L 54 cm  
 washbasin unit min W 54 cm  
 meuble sous-vasque min L 54 cm  
 Waschtischunterschrank min B 54

piano sospeso min L 54 cm  
 wall counter top min W 54 cm  
 plan suspendu pour l'ameublement min L 54 cm  
 aufgehängte Platte fuer Einrichtung min B 54 cm

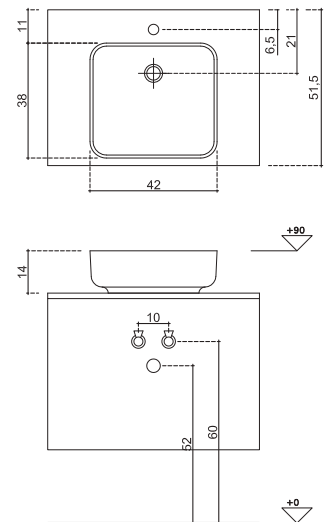
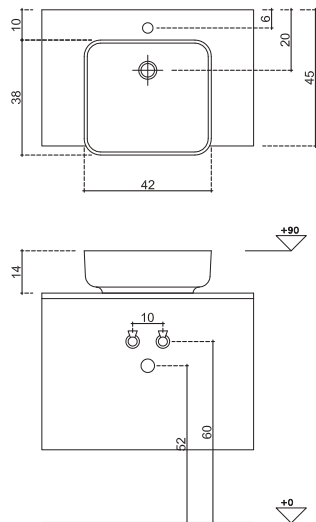

LAVABO SOPRAPIANO DA INCASSO AROCK®





## ENCATRO

Lavabo soprapiano da incasso in Arock®  
Arock® recessed basin  
Lavabo encastré surélevé en Arock®  
Halbeinbaubecken aus Arock®

## GGKL5010



non provvisto di scarico troppopieno  
without overflow system  
sans système de trop-plein  
ohne Überlaufsystem

kit piletta e sifone da ordinare separatamente  
waste kit and siphon to be ordered separately  
kit bonde d'évacuation et siphon à commander séparément  
Ablauf Kit und Siphon müssen separat bestellt werden

AROCK®

## ENCATRO



su basi portalavabo min L 54 cm  
 washbasin unit min W 54 cm  
 meuble sous-vasque min L 54 cm  
 Waschtischunterschrank min B 54

piano sospeso min L 54 cm  
 wall counter top min W 54 cm  
 plan suspendu pour l'ameublement min L 54 cm  
 aufgehängte Platte fuer Einrichtung min B 54 cm

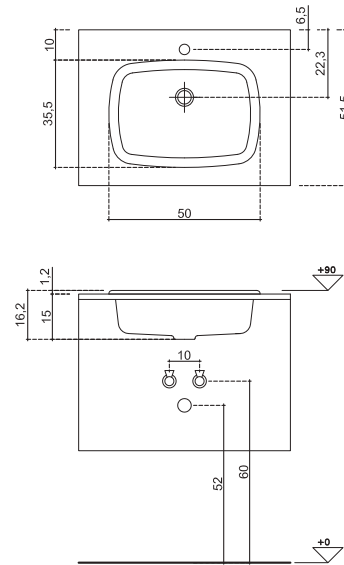



LAVABO SOTTOPIANO DA INCASSO AROCK®





**FRIBBIO**

Lavabo sottopiano da incasso in Arock®  
 Arock® undermounted basin  
 Lavabo en profondeur en Arock®  
 Untereinbaubecken aus Arock®

**GGKL6001**

27,3

60

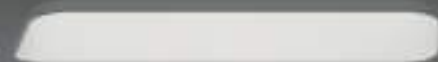
**ZONFO**

Lavabo sottopiano da incasso in Arock®  
 Arock® undermounted basin  
 Lavabo en profondeur en Arock®  
 Untereinbaubecken aus Arock®

**GGKL4201**

27,3

42

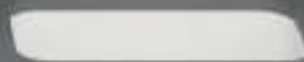

non provvisto di scarico troppopieno  
 without overflow system  
 sans système de trop-plein  
 ohne Überlaufsystem

kit piletta e sifone da ordinare separatamente  
 waste kit and siphon to be ordered separately  
 kit bonde d'évacuation et siphon à commander séparément  
 Ablauf Kit und Siphon müssen separat bestellt werden

non provvisto di scarico troppopieno  
 without overflow system  
 sans système de trop-plein  
 ohne Überlaufsystem

kit piletta e sifone da ordinare separatamente  
 waste kit and siphon to be ordered separately  
 kit bonde d'évacuation et siphon à commander séparément  
 Ablauf Kit und Siphon müssen separat bestellt werden

AROCK®

## FRIBBIO



su basi portalavabo min L 80 cm  
 washbasin unit min W 80 cm  
 meuble sous-vasque min L 80 cm  
 Waschtischunterschrank min B 80 cm

piano sospeso min L 80 cm  
 wall counter top min W 80 cm  
 plan suspendu pour l'ameublement min L 80 cm  
 aufgehängte Platte fuer Einrichtung min B 80 cm

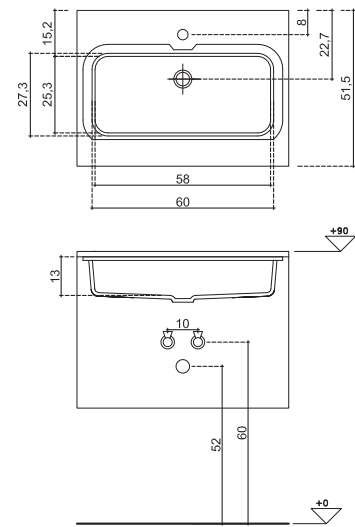
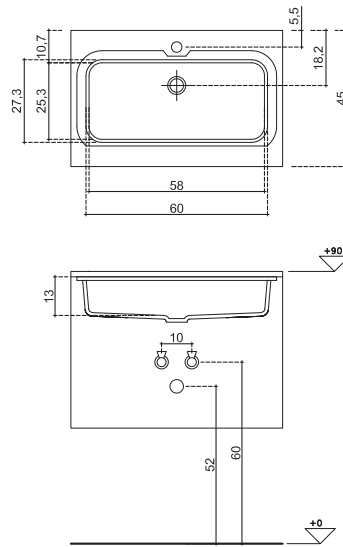

## ZONFO



su basi portalavabo min L 60 cm  
 washbasin unit min W 60 cm  
 meuble sous-vasque min L 60 cm  
 Waschtischunterschrank min B 60 cm

piano sospeso min L 60 cm  
 wall counter top min W 60 cm  
 plan suspendu pour l'ameublement min L 60 cm  
 aufgehängte Platte fuer Einrichtung min B 60 cm

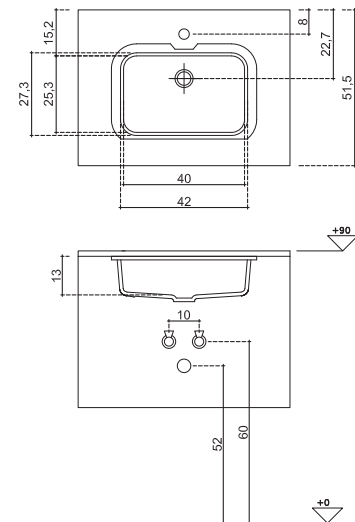
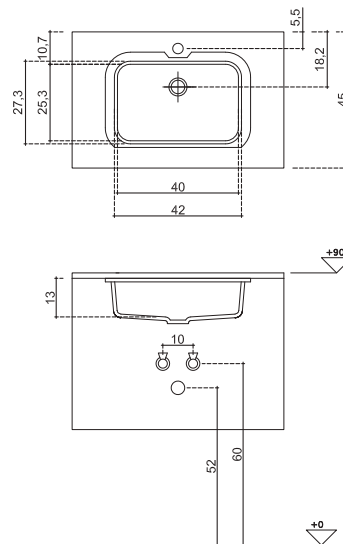







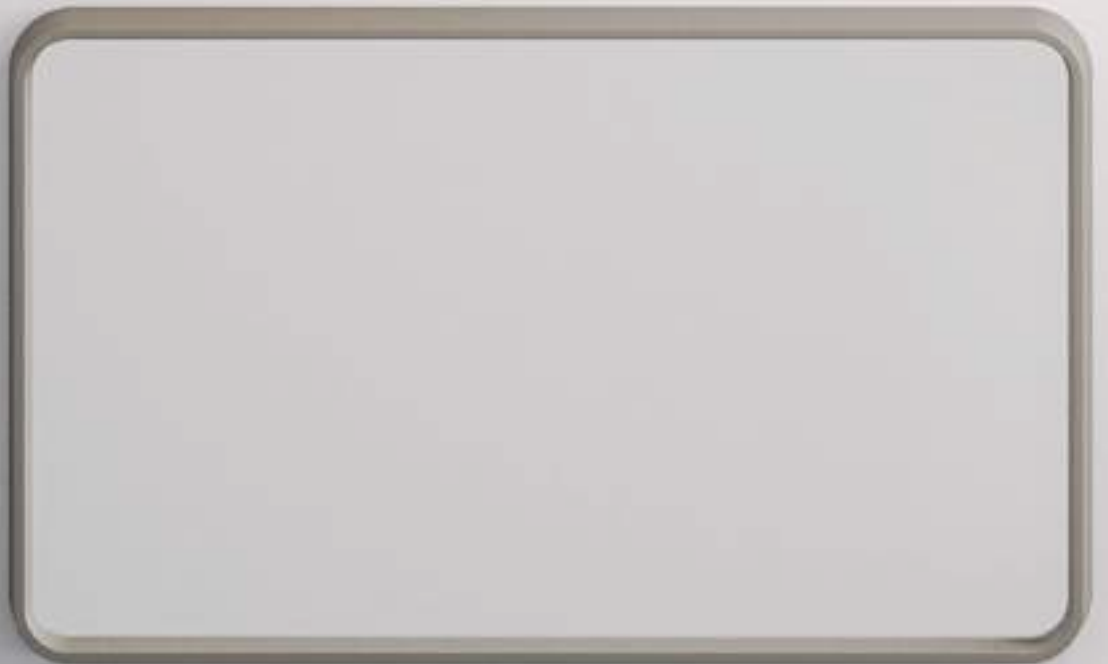
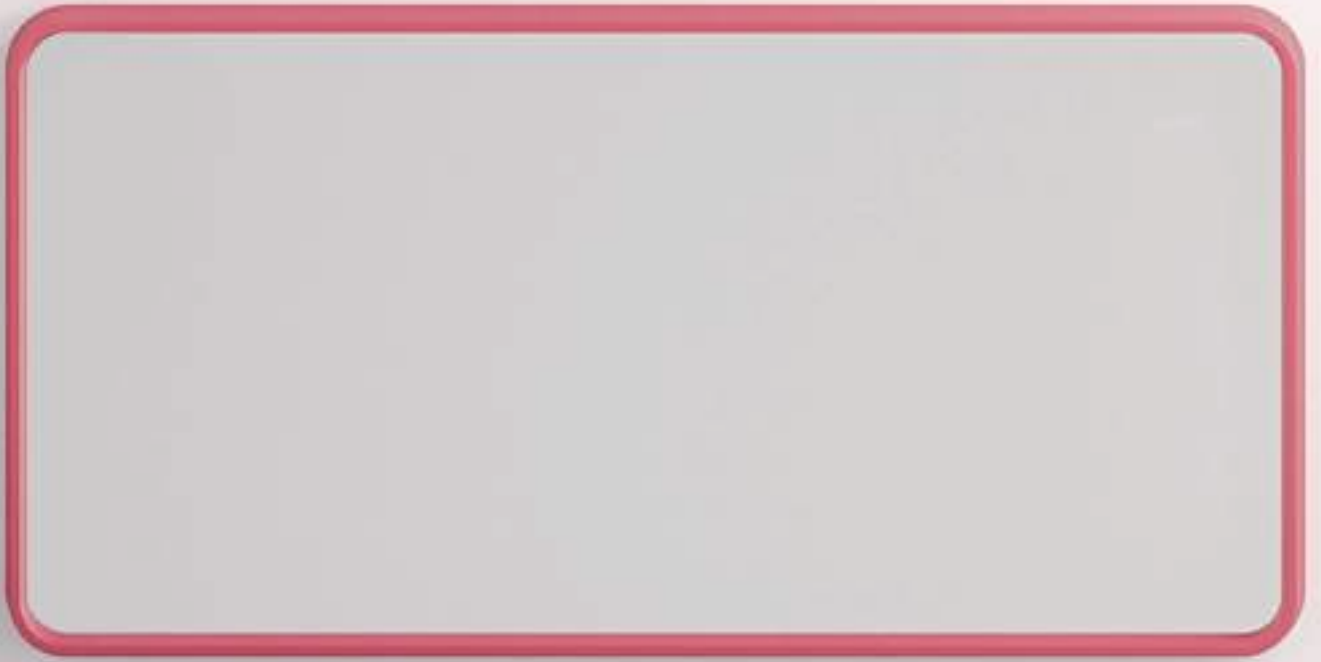



- . specchio con cornice Arock® disponibile in 48 colori.02
- . senza o con illuminazione integrata a LED
- . 7 misure e 2 tipologie di installazione, orizzontale e verticale

- . miroir avec cadre Arock® en 48 colori.02
- . sans ou avec éclairage LED intégré
- . 7 mesures et 2 installations différentes, horizontales et verticales

- . mirror with frame Arock® in 48 colori.02
- . without or with integrated LED lighting
- . 7 measures and 2 different installations, horizontal and vertical

- . Spiegel mit Rahmen Arock® in 48 colori.02
- . ohne oder mit integrierter LED-Beleuchtung
- . 7 Maße und 2 verschiedene Installationen, horizontal und vertikal

## Arock®

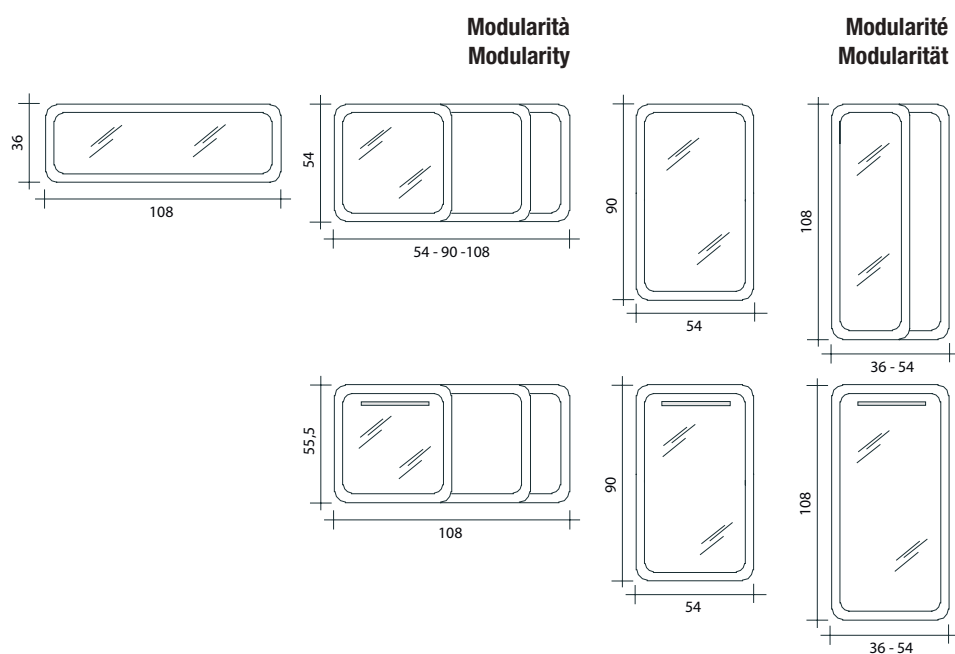
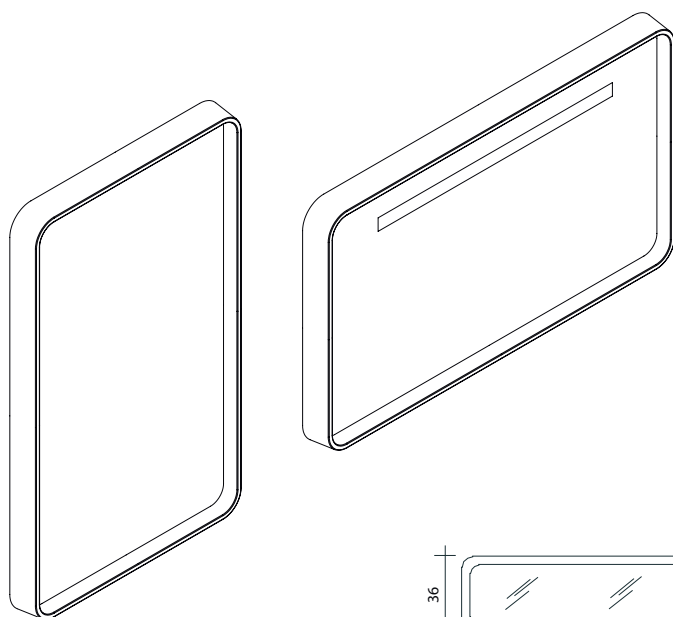
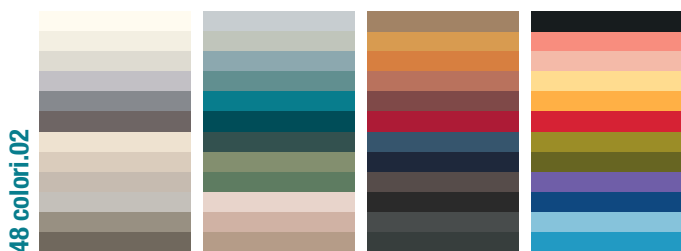

# Specchi Mirrors

# Miroirs Spiegel

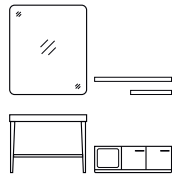

ALCENTIMETRO  
PROGETTO

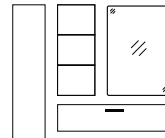

Elementi  
CONTENITORI

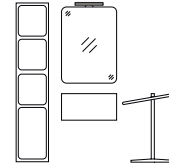

Elementi  
COMPLEMENTARI



RICAMBI

98

180

226

592

## H 36



## P 6

Specchio • cornice Arock®  
Mirror • frame Arock®  
Miroir • cadre Arock®  
Spiegel • Rahmen Arock®

### L

108 GGKSP022

### F4

## H 54

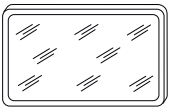

## P 6

Specchio • cornice Arock®  
Mirror • frame Arock®  
Miroir • cadre Arock®  
Spiegel • Rahmen Arock®

### L

54 GGKSP012

90 GGKSP014

108 GGKSP015

### F4

## H 90

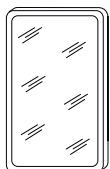

## P 6

Specchio • cornice Arock®  
Mirror • frame Arock®  
Miroir • cadre Arock®  
Spiegel • Rahmen Arock®

### L

54 GGKSP018

### F4

H  
L  
P

Misure in cm  
Measures in cm  
Mesures en cm  
Maße in cm

**F1** Laccato opaco  
Matt lacquered  
Laqué mat  
Matt lackiert

**F2** Laccato lucido  
Glossy lacquered  
Laqué brillant  
Hochglanz lackiert

**F3** Nobilitati  
Veneer wood  
Placage bois  
Beschichtetes Holz

**F4** Arock®  
Arock®  
Arock®  
Arock®

**F5** abitat / vogue  
abitat / vogue  
abitat / vogue  
abitat / vogue



# Specchi Mirrors

# Miroirs Spiegel

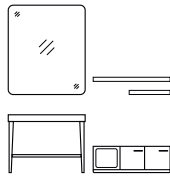

ALCENTIMETRO  
PROGETTO

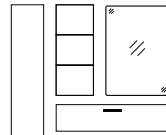

Elementi  
CONTENITORI

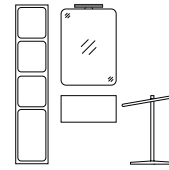

Elementi  
COMPLEMENTARI



RICAMBI

98

180

226

592

## H 108



## P 6

Specchio • cornice Arock®  
Mirror • frame Arock®  
Miroir • cadre Arock®  
Spiegel • Rahmen Arock®

L	F4		
36	GGKSP020		
54	GGKSP021		

## H 54

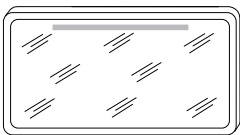

## P 6

Specchio • cornice Arock® + illuminazione LED integrata  
Mirror • frame Arock® + LED lighting  
Miroir • cadre Arock® + éclairage par LED  
Spiegel • Rahmen Arock® + LED Beleuchtung

L	F4		
54	GGKSP002		
90	GGKSP004		
108	GGKSP005		

## H 90

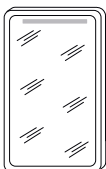

## P 6

Specchio • cornice Arock® + illuminazione LED integrata  
Mirror • frame Arock® + LED lighting  
Miroir • cadre Arock® + éclairage par LED  
Spiegel • Rahmen Arock® + LED Beleuchtung

L	F4		
54	GGKSP008		



Misure in cm  
Measures in cm  
Mesures en cm  
Maße in cm

**F1** Laccato opaco  
Matt lacquered  
Laqué mat  
Matt lackiert

**F2** Laccato lucido  
Glossy lacquered  
Laqué brillant  
Hochglanz lackiert



**F3** Nobilitati  
Veneer wood  
Placage bois  
Beschichtetes Holz

**F4** Arock®  
Arock®  
Arock®  
Arock®

**F5** abitat / vogue  
abitat / vogue  
abitat / vogue  
abitat / vogue

## Specchi Mirrors

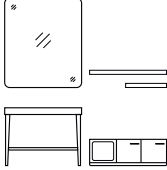
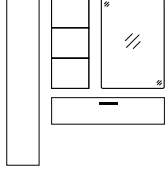
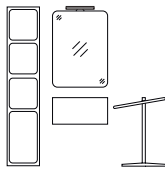
## Miroirs Spiegel

	 <p>ALCENTIMETRO PROGETTO</p>	 <p>Elementi CONTENITORI</p>	 <p>Elementi COMPLEMENTARI</p>	 <p>RICAMBI</p>
	98	180	226	592

### H 108

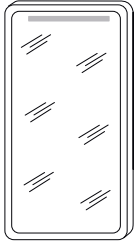

### P 6

Specchio • cornice Arock® + illuminazione LED integrata  
 Mirror • frame Arock® + LED lighting  
 Miroir • cadre Arock® + éclairage par LED  
 Spiegel • Rahmen Arock® + LED Beleuchtung

### L

54 GGKSP011

### F4

 Misure in cm  
 Measures in cm  
 Mesures en cm  
 Maße in cm

**F1** Laccato opaco  
 Matt lacquered  
 Laqué mat  
 Matt lackiert

**F2** Laccato lucido  
 Glossy lacquered  
 Laqué brillant  
 Hochglanz lackiert

**F3** Nobilitati  
 Veneer wood  
 Placage bois  
 Beschichtetes Holz

**F4** Arock®  
 Arock®  
 Arock®  
 Arock®

**F5** abitat / vogue  
 abitat / vogue  
 abitat / vogue  
 abitat / vogue





. portasalviette free-standing con base in Arock® ottenuta da stampo disponibile in 48 colori.02  
 . struttura in alluminio anodizzato disponibile in finitura abitat e vogue o in 48 colori.02 laccato OPACO

. towel stand holder with molded Arock® base in 48 colori.02  
 . anodized aluminum structure available in abitat and vogue finishing or in 48 colori.02 MATT lacquered

. porte-serviettes autoportant avec base moulée Arock® en 48 colori.02  
 . structure en aluminium anodisé disponible en finition abitat et vogue ou en 48 colori.02 MAT laqué

. Handtuchhalter-stehend mit geformter Arock®-Basis in 48 colori.02  
 . eloxierte Aluminiumstruktur in abitat und vogue Ausführung erhältlich oder in 48 colori.02 MATT Lackiert

### abitat / vogue



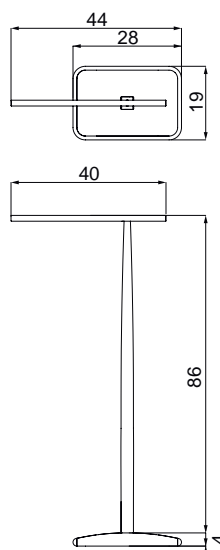
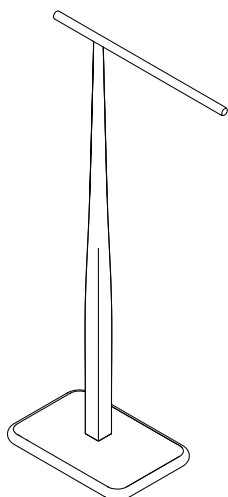

### Arock® & laccato OPACO Arock® & MATT lacquered Arock® & laqué MAT Arock® & MATT Lackiert

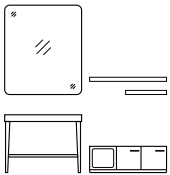
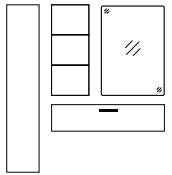
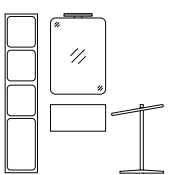

## Portasalvietta free-standing Towel stand

## Porte-serviettes Handtuchhalter-stehend

	 <p>ALCENTIMETRO PROGETTO</p>	 <p>Elementi CONTENITORI</p>	 <p>Elementi COMPLEMENTARI</p>	 <p>RICAMBI</p>
	98	180	226	592

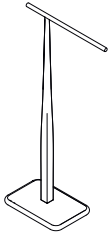
**H 90****P 44**

Portasalvietta free-standing  
Towel stand  
Porte-serviettes  
Handtuchhalter-stehend

**L**

19 GGKP4022

**F1****F5**

  
 H  
 L  
 P

Misure in cm  
Measures in cm  
Mesures en cm  
Maße in cm

**F1** Laccato opaco  
Matt lacquered  
Laqué mat  
Matt lackiert

**F2** Laccato lucido  
Glossy lacquered  
Laqué brillant  
Hochglanz lackiert

**F3** Nobilitati  
Veneer wood  
Placage bois  
Beschichtetes Holz

**F4** Arock®  
Arock®  
Arock®  
Arock®

**F5** abitat / vogue  
abitat / vogue  
abitat / vogue  
abitat / vogue





## COLONNINA

## UNICAMENTE

AROCK®

- . colonnina in Arock® disponibile in 48 colori.02
- . ottenuta da stampo nelle dimensioni 17 x 108 x 12 cm
- . 2 tipologie di installazione, orizzontale e verticale

- . Arock® shelving unit available in 48 colori.02
- . molded in the dimensions 17 x 108 x 12 cm
- . 2 types of installation, horizontal and vertical

- . étagère Arock® disponible en 48 colori.02
- . moulé aux dimensions 17 x 108 x 12 cm
- . 2 types d'installation, horizontale et verticale

- . Arock® Regal erhältlich in 48 colori.02
- . geformt in den Maßen 17 x 108 x 12 cm
- . 2 Montagearten, horizontal und vertikal

## Arock®

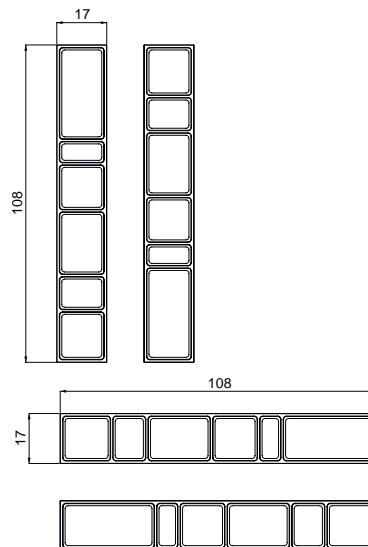
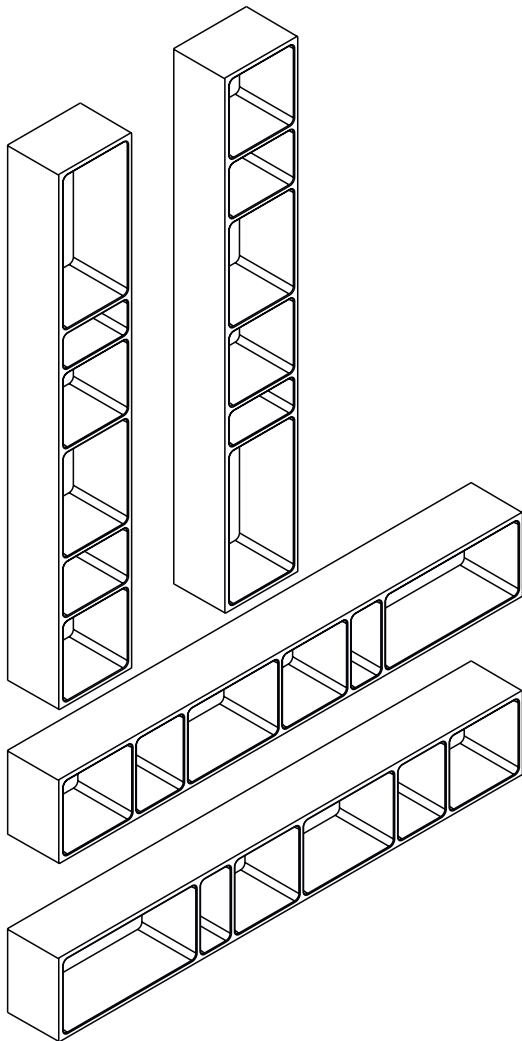
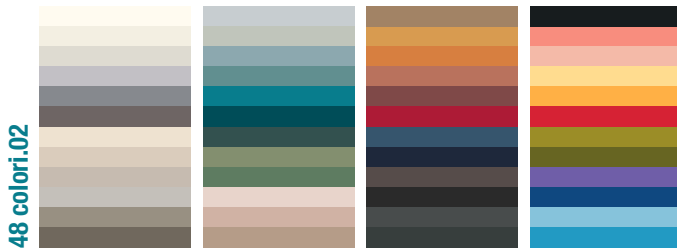

## Colonnina Shelving unit

## Étagère Regalelement

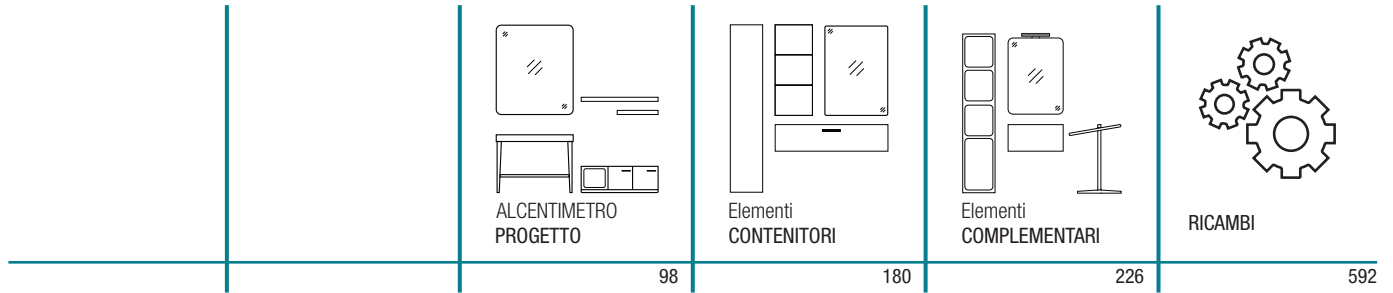

### H 17



### P 12

Colonnina P 12  
Shelving unit P 12  
Étagère P 12  
Regalelement T 12

### L

108 GGKC2108

### F4

### H 17

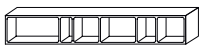

### P 12

Colonnina P 12  
Shelving unit P 12  
Étagère P 12  
Regalelement T 12

### L

108 GGKC4108

### F4

### H 108

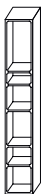

### P 12

Colonnina P 12  
Shelving unit P 12  
Étagère P 12  
Regalelement T 12

### L

17 GGKC6108

### F4



Misure in cm  
Measures in cm  
Mesures en cm  
Maße in cm

### F1

Laccato opaco  
Matt lacquered  
Laqué mat  
Matt lackiert

### F2

Laccato lucido  
Glossy lacquered  
Laqué brillant  
Hochglanz lackiert

### F3

Nobilitati  
Veneer wood  
Placage bois  
Beschichtetes Holz

### F4



Arock®  
Arock®  
Arock®  
Arock®

### F5

abitat / vogue  
abitat / vogue  
abitat / vogue  
abitat / vogue

## Colonnina Shelving unit

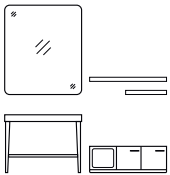
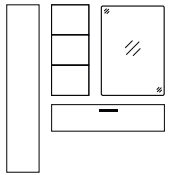
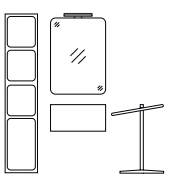
## Étagère Regalelement

	 <p>ALCENTIMETRO PROGETTO</p>	 <p>Elementi CONTENITORI</p>	 <p>Elementi COMPLEMENTARI</p>	 <p>RICAMBI</p>
	98	180	226	592

**H 108**

**P 12**

Colonnina P 12  
Shelving unit P 12  
Étagère P 12  
Regalelement T 12

**L**

17 GGKC8108

**F4**

Misure in cm  
Measures in cm  
Mesures en cm  
Maße in cm

**F1** Laccato opaco  
Matt lacquered  
Laqué mat  
Matt lackiert

**F2** Laccato lucido  
Glossy lacquered  
Laqué brillant  
Hochglanz lackiert

**F3** Nobilitati  
Veneer wood  
Placage bois  
Beschichtetes Holz

**F4** Arock®  
Arock®  
Arock®  
Arock®

**F5** abitat / vogue  
abitat / vogue  
abitat / vogue  
abitat / vogue







- . pomolo in Arock® disponibile in 48 colori.02
- . ottenuto da stampo in dimensioni 20 x 11 x 6 cm
- . 2 tipologie di installazione, orizzontale e verticale

- . Arock® towel hook available in 48 colors.02
- . molded in the dimensions 20 x 11 x 6 cm
- . 2 types of installation, horizontal and vertical

- . porte-serviettes en Arock® disponible en 48 colori.02
- . moulé aux dimensions 20 x 11 x 6 cm
- . 2 types d'installation, horizontale et verticale

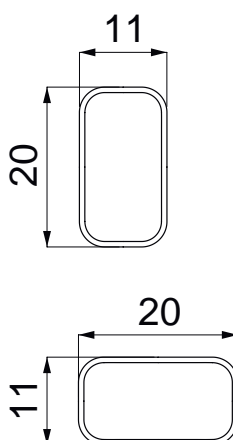
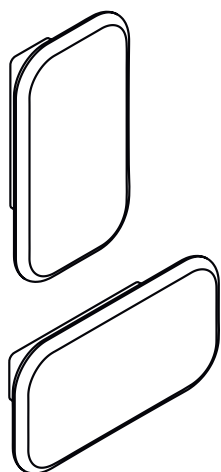
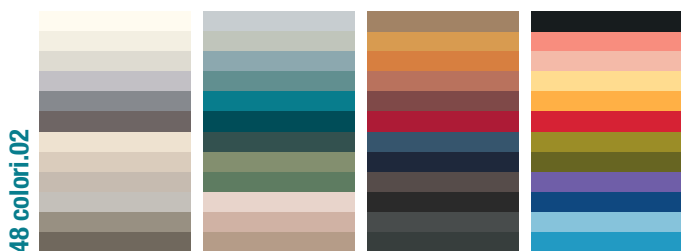

- . Arock® Handtuchhalter in 48 colori.02
- . geformt in den Maßen 20 x 11 x 6 cm
- . 2 Montagearten, horizontal und vertikal

## Arock®

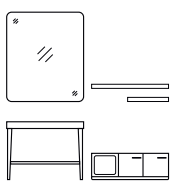
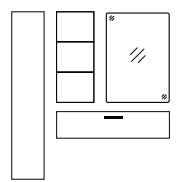
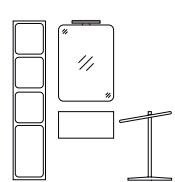

## Pomolo Towel hook Arock®

## Porte-serviettes en Arock® Arock® Handtuchhalter

	 <p>ALCENTIMETRO PROGETTO</p>	 <p>Elementi CONTENITORI</p>	 <p>Elementi COMPLEMENTARI</p>	 <p>RICAMBI</p>
	98	180	226	592

### H 11



Pomolo  
Towel hook Arock®  
Porte-serviettes en Arock®  
Arock® Handtuchhalter

**L**

20 GGKP3017

**F4**



Misure in cm  
Measures in cm  
Mesures en cm  
Maße in cm

**F1** Laccato opaco  
Matt lacquered  
Laqué mat  
Matt lackiert

**F2** Laccato lucido  
Glossy lacquered  
Laqué brillant  
Hochglanz lackiert

**F3** Nobilitati  
Veneer wood  
Placage bois  
Beschichtetes Holz

**F4** Arock®  
Arock®  
Arock®  
Arock®

**F5** abitat / vogue  
abitat / vogue  
abitat / vogue  
abitat / vogue

- . mensola in 48 colori.02
- . ottenuta da stampo nelle dimensioni 17 x 54/63 x 12 cm
- . 1 tipologia di installazione, orizzontale

- . shelf in 48 colori.02
- . molded in the dimensions 17 x 54/63 x 12 cm
- . 1 type of installation, horizontal

- . étagère disponible en 48 colori.02
- . moulé aux dimensions 17 x 54/63 x 12 cm
- . 1 type d'installation, horizontale

- . Regalelement in 48 colori.02
- . geformt in den Maßen 17 x 54/63 x 12 cm
- . 1 Montagearte, horizontal

## Arock®

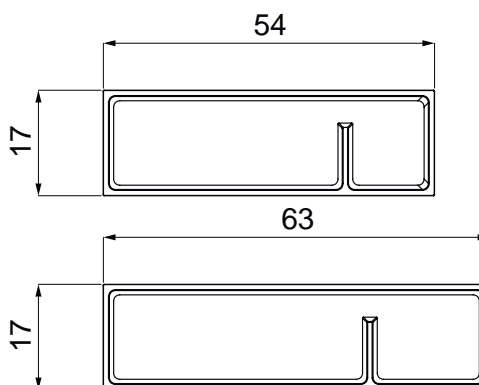
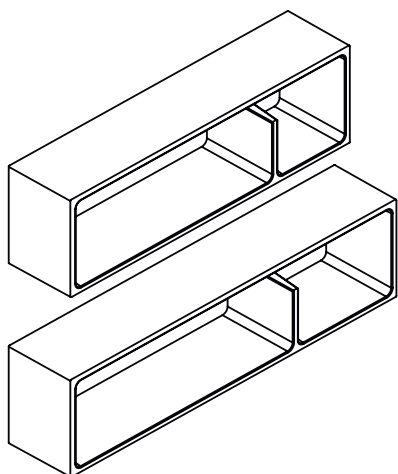
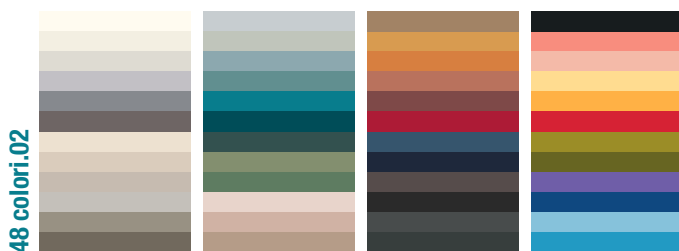

# Mensola Shelf

# Étagère Regalelement

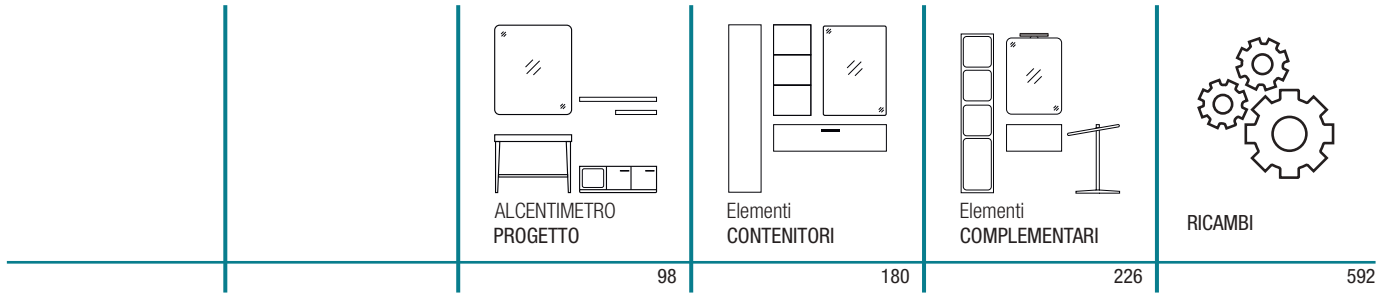

## H 17



## P 12

Mensola P 12  
Shelf P 12  
Étagère P 12  
Regalelement T 12

### L

54 GGKM2054

### F4

## H 17

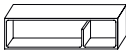

## P 12

Mensola P 12  
Shelf P 12  
Étagère P 12  
Regalelement T 12

### L

63 GGKM2063

### F4



Misure in cm  
Measures in cm  
Mesures en cm  
Maße in cm

### F1

Laccato opaco  
Matt lacquered  
Laqué mat  
Matt lackiert

### F2

Laccato lucido  
Glossy lacquered  
Laqué brillant  
Hochglanz lackiert

### F3

Nobilitati  
Veneer wood  
Placage bois  
Beschichtetes Holz

### F4

Arock®  
Arock®  
Arock®  
Arock®

### F5

abitat / vogue  
abitat / vogue  
abitat / vogue  
abitat / vogue







- . mensola in Arock® disponibile in 48 colori.02
- . ottenuta da stampo nelle dimensioni 17 x 54/63 x 12 cm
- . 1 tipologia di installazione, orizzontale
- . portasalviette in alluminio anodizzato disponibile in finitura abitat/vogue o in 48 colori.02 laccato OPACO

- . Arock® shelf available in 48 colori.02
- . molded in the dimensions 17 x 54/63 x 12 cm
- . 1 type of installation, horizontal
- . anodized aluminum towel holder available in abitat/vogue finishing or in 48 colori.02 MATT lacquered

- . étagère Arock® disponible en 48 colori.02
- . moulé aux dimensions 17 x 54/63 x 12 cm
- . 1 type d'installation, horizontale
- . porte-serviettes en aluminium anodisé disponible en finition abitat/vogue ou en 48 colori.02 MATT laqué

- . Arock® Regalelement in 48 colori.02
- . geformt in den Maßen 17 x 54/63 x 12 cm
- . 1 Montagearte, horizontal
- . eloxierte Aluminiumstruktur Handtuchhalter in abitat/vogue Ausführung erhältlich oder in 48 colori.02 MATT Lackiert

### abitat / vogue



### Arock® & laccato OPACO Arock® & MATT lacquered Arock® & laqué MAT Arock® & MATT Lackiert

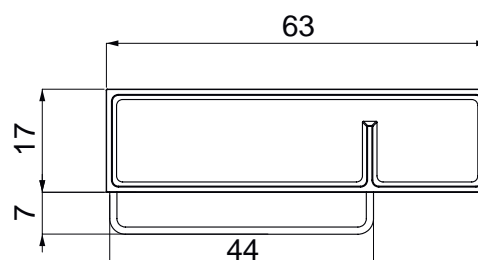
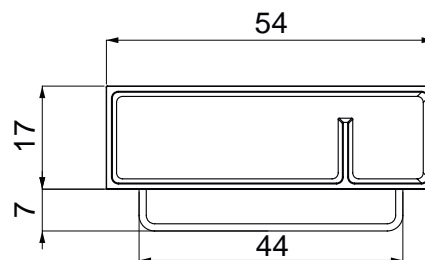
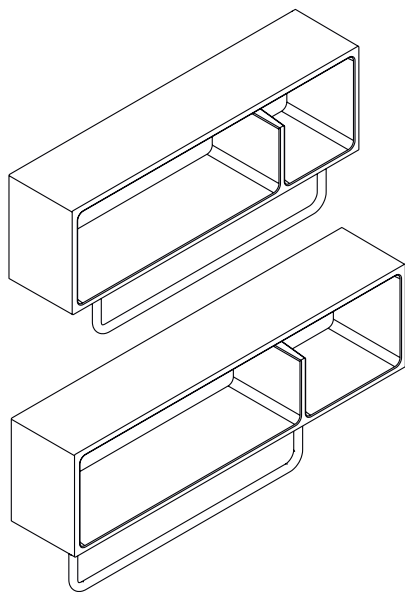
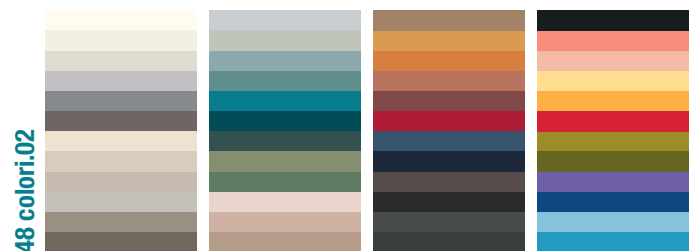

## Mensola Shelf

## Étagère Regalelement

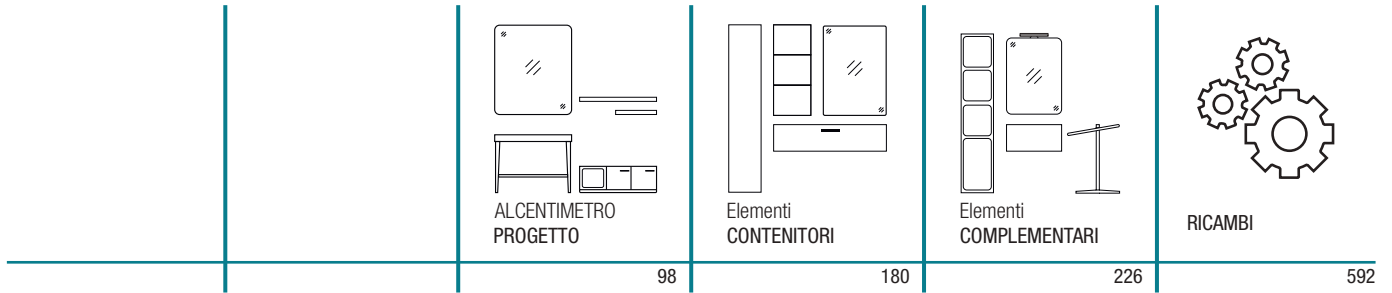
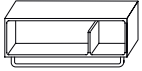
**H 17**

**P 12**

Mensola + portasalviette  
Shelf + towel rail  
Étagère + porte-serviettes  
Regalelement + Handtuchhalter

**L**

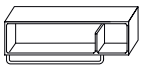
54 GGKM3054

**F1**
**F5**
**H 17**

**P 12**

Mensola + portasalviette  
Shelf + towel rail  
Étagère + porte-serviettes  
Regalelement + Handtuchhalter

**L**

63 GGKM3063

**F1**
**F5**

H  
L  
P

Misure in cm  
Measures in cm  
Mesures en cm  
Maße in cm

**F1** Laccato opaco  
Matt lacquered  
Laqué mat  
Matt lackiert

**F2** Laccato lucido  
Glossy lacquered  
Laqué brillant  
Hochglanz lackiert

**F3** Nobilitati  
Veneer wood  
Placage bois  
Beschichtetes Holz

**F4** Arock®  
Arock®  
Arock®  
Arock®

**F5** abitat / vogue  
abitat / vogue  
abitat / vogue  
abitat / vogue



Chichén Itzá è un importante complesso archeologico Maya, situato a Nord della penisola dello Yucatán, realizzato fra il VI e l'XI secolo. Le rovine si estendono su un'area di 3 km<sup>2</sup> e comprendono numerosi edifici rappresentativi di diversi stili architettonici, fra i più celebri sono la Piramide di Kulkulkan, l'Osservatore Astronomico e il Tempio dei Guerrieri. Nel 1988 dichiarato patrimonio dell'umanità dall'UNESCO, amministrato dall'Istituto Nacional de Antropología e Historia, dal 2007 è inserito fra le Sette Meraviglie del Mondo Moderno





Chichén Itzá is an important Maya archaeological structure located in the North of the Yucatán peninsula in Mexico. Chichén Itzá was created between the VI and the XI centuries. The ruins occupy an area of 3 square kilometers, and they include numerous buildings, which represent different architectural styles, such as the Kukulcan Pyramid, the Astronomical Observatory, and the Temple of the Warriors.

In 1988, UNESCO declared the site a heritage of the humanity. Today, Chichén Itzá is administered by the Instituto Nacional de Antropología e Historia. In addition, since 2007, it has been included in the Modern World's Seven Wonders





SISTEMA PER ARREDARE CON I NOSTRI PRODOTTI IN QUARANTOTTO COLORI	ALCENTIMETRO		PROGETTO
	E CON LE VOSTRE MISURE		
	PIANI SOSPESI		TUTTI
	FILOPIANO LAVABO INTEGRATO SOSPESO		AROCK®
	SHAMBOLA®		CONSOLE PER LAVABO
	SHAMBOLA®		CONSOLE PER LAVABO CON TAVOLO
	SHAMBOLA®		CONSOLE PER TAVOLO E TAVOLO DA INGRESSO
	FILOPIANO LAVABI INTEGRATI PER MOBILI		CRISTALLO - AROCK®
	PIANI PER MOBILI		TUTTI
	PIANI PER BASI D'ARREDO		TUTTI
	SPECCHI LINEO E AERO		REVERSIBILI
	MENSOLA		NOBILITATO - LACCATO OPACO/LUCIDO
	PANCA		
	BANCONE		
	ZOCCOLO D'ARREDO H 3		



PIANI SOSPESI

TUTTI

FILOPIANO LAVABO INTEGRATO SOSPESO

AROCK®

## lavabo / basin / vasque / Becken



lavabo integrato  
integrated basin  
vasque intégrée  
integriertes Becken

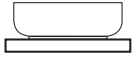

soprapiano da appoggio  
countertop basin  
lavabo á poser  
Aufsetzbecken



soprapiano da incasso  
recessed basin  
lavabo encastré surélevé  
Halbeinbaubecken

		P 45 / 51,5 cm	
<p>piano sospeso wall counter top plan suspendu aufgehängte Platte</p> <p><b>H 6 / 10 / 15 cm</b></p>			<p>HPL Nobilitato LEGNO/ALTATTO Laccato OPACO/LUCIDO Arock®</p>
<p>piano sospeso accoppiato wall counter coupled top plan suspendu couplé aufgehängte doppelte Platte</p> <p><b>H 6,6 / 10,6 / 15,6 cm</b></p>			<p>GRES accoppiato</p>
<p>piano sospeso per lavabo soprapiano da appoggio wall counter-mounted counter top basin plan suspendu pour les lavabos aufgehängte Platte fuer die Waschbecken</p> <p><b>H 6 / 10 / 15 cm</b></p>			<p>HPL Nobilitato LEGNO/ALTATTO Laccato OPACO/LUCIDO Arock®</p>
<p>piano sospeso accoppiato per lavabo soprapiano da appoggio wall counter-mounted coupled counter top basin plan suspendu couplé pour les lavabos aufgehängte doppelte Platte fuer die Waschbecken</p> <p><b>H 6,6 / 10,6 / 15,6 cm</b></p>			<p>GRES accoppiato</p>
<p>piano sospeso per lavabo soprapiano da incasso wall counter-mounted counter top basin plan suspendu pour les lavabos encastré aufgehängte Platte für Halbeinbaubecken</p> <p><b>H 10 / 15 cm</b></p>			<p>HPL Nobilitato LEGNO/ALTATTO Laccato OPACO/LUCIDO Arock®</p>
<p>piano sospeso accoppiato per lavabo soprapiano da incasso wall counter-mounted coupled counter top basin plan suspendu couplé pour les lavabos encastré aufgehängte doppelte Platte für Halbeinbaubecken</p> <p><b>H 10,6 / 15,6 cm</b></p>			<p>GRES accoppiato</p>
<p>filopiano lavabo integrato sospeso wall-mounted integrated top basin plan suspendu pour les lavabos aufgehängte Platte fuer die Waschbecken</p> <p><b>H 6 / 10 / 15 cm</b></p>			<p>Arock®</p>



**come calcolare il prezzo**  
**how to calculate the price**
**comment calculer le prix**  
**wie berechnet man den Preis**

1. scegliere la tipologia di lavabo desiderato  
choose your type of basin  
choisissez le type de lavabo que vous préférez  
wählen Sie den gewünschten Becken
2. verificare la profondità necessaria del piano sospeso, per l'installazione del lavabo scelto  
check the depth of the free-standing top needed to install your basin  
vérifier la profondeur du plan suspendu nécessaire pour installer le lavabo choisi  
überprüfen Sie die Tiefe der Freistehndeplatte, der für die Installation der Becken erforderlich ist
3. stabilire il materiale e la lunghezza del piano sospeso  
decide material and length of the free-standing top  
établir le matériau et la longueur du plan suspendu  
stellen Sie das Material und die Länge der Freistehndeplatte fest
4. calcolare il prezzo totale usando la tabella al cm lineare del piano sospeso scelto  
calculate the total price using the cost per cm of the chosen free-standing top  
calculer le prix total en utilisant le cout linéaire par cm du plan suspendu choisi  
berechnen Sie den Gesamtpreis anhand der linearen Kosten in cm des gewählten Freistehndeplatte
5. aggiungere il prezzo di eventuali variabili in tabella  
add the price of any variables to be found in the table  
ajouter le prix des variables dans le tableau  
addieren Sie den Preis aller Variablen in der Tabelle
6. aggiungere il prezzo del numero di staffe secondo la lunghezza del piano sospeso  
add the price of the brackets according to the length of the free-standing top  
ajouter le prix du nombre de supports en fonction de la longueur du plan suspendu  
addieren Sie den Preis fuer die Wandhalterungen

**attenzione - note**  
**attention - notes**
**attention - notes**  
**achtung - Notizen**

- i fori per la rubinetteria NON prevedono sovrapprezzo  
NO extra costs for tap holes  
PAS frais supplémentaires pour les trous de robinetterie  
KEINE zusätzlichen Kosten fuer Waschenbeckenlöcher
- i piani di misura inferiore alla L minima indicata, NON sono realizzabili  
NO smaller size than the one indicated for the top  
PAS la mesure inférieure au minimum indiqué pour plan  
KEIN Plan niedriger als das angegebene Minimum
- le lavorazioni a smusso e per i cambi di profondità NON sono ammesse  
NO bevel cuts and depth changing  
PAS change de la profondeur et coupe en biseau  
KEIN abgeschrägter Schnitt und Änderung der Tiefe
- i piani con dima e/o disegno tecnico, hanno un sovrapprezzo di **300 €**  
**300 €** extra cost for tops with template or technical drawing  
extra cost for tops with template or technical drawing **300 €**  
Platte mit Vorlage oder technischer Zeichnung haben einen Aufpreis von **300 €**
- la scheda tecnica di un lavabo non presente nel nostro listino è indispensabile per la produzione del piano  
the technical data sheet of a washbasin not indicated in our price list is essential for the production of the top  
la fiche technique d'une vasque non présente dans notre tarif est indispensable pour la réalisation du plan  
das technische Datenblatt eines Becken, das nicht in unserer Preisliste enthalten ist, ist für die Herstellung des Tops zwingend erforderlich



PIANO SOSPEO

**HPL - HIGH PRESSURE LAMINATE**

laminato stratificato ad alta pressione costituito da fogli di cellulosa impregnati con resine fenoliche

high pressure layered laminate, a perfect and strong imitation of the natural wooden surface

stratifiés decoratifs haute pression. Plaques à base de résines thermodurcissables appelées stratifiés

Hochdruckmehrschichtlaminat mit einer dreidimensionalen Erscheinung

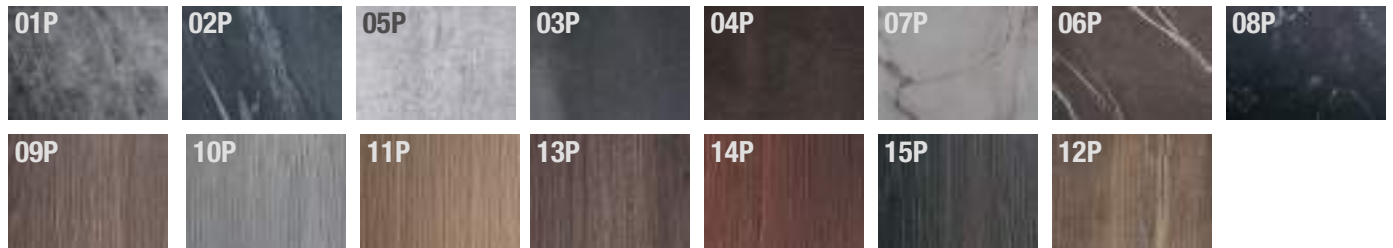

cod.	P	H	al cm lineare per linear cm au cm linéaire pro cm	+ prezzo foro lavabo + washbasin hole price + prix du trou pour vasque + Preis für Waschbeckenloch	
PSDA4506 PSDA5106	45 51,5	6 6			
PSDL4506 PSDL5106	45 51,5	6 6			
PSDA4510 PSDA5110	45 51,5	10 10			
PSDL4510 PSDL5110	45 51,5	10 10			
PSDA4515 PSDA5115	45 51,5	15 15			
PSDL4515 PSDL5115	45 51,5	15 15			

Staffa di sostegno - ordinare separatamente  
Brackets - order separately  
Supports - commander séparément  
Wandhalterungen - Separat bestellen

cod. OMZSTA06

< L 90 - 2 pz  
L 91 ÷ 130 - 3 pz  
L 131 ÷ 180 - 4 pz  
L 181 ÷ 210 - 5 pz

## AROCK®

materiale composito ottenuto da una miscela di carbonati e resine poliestere con finitura superficiale liscia Arock®. Elevata resistenza alle aggressioni chimiche e batteriche

special material composed of carbonates and polyhedral resins. Smooth surface Arock®

matériau spécial composé de carbonates et de résines polyester. Surface lisse Arock®

Spezialwerkstoff aus Carbonaten und Polyesterhärzen Glatte Oberflächen Arock®



Per calcolare il prezzo totale del PIANO SOSPESO sommare al prezzo dei primi 50 cm il prezzo dei centimetri restanti

To calculate the total price of the freestanding top, add the price of the remaining cm to the price of the first 50 cm

Pour calculer le prix total de la console à libre installation, ajouter le prix du cm restant au prix des 50 premiers cm

Um den Gesamtpreis für den Freistehendeplatte zu berechnen, addieren Sie den Preis für die verbleibenden cm zum Preis für die ersten 50 cm

cod.	P	H	< 50 cm	al cm lineare per linear cm au cm linéaire pro cm	+ prezzo foro lavabo + washbasin hole price + prix du trou pour vasque + Preis für Waschbeckenloch	
PSHA4506	45	6				
PSHA5106	51,5	6				
PSHL4506	45	6				
PSHL5106	51,5	6				
PSHA4510	45	10				
PSHA5110	51,5	10				
PSHL4510	45	10				
PSHL5110	51,5	10				
PSHA4515	45	15				
PSHA5115	51,5	15				
PSHL4515	45	15				
PSHL5115	51,5	15				

Staffa di sostegno - ordinare separatamente  
Brackets - order separately  
Supports - commander séparément  
Wandhalterungen - Separat bestellen

cod. OMZSTA06

< L 90 - 2 pz  
L 91 ÷ 130 - 3 pz  
L 131 ÷ 180 - 4 pz  
L 181 ÷ 210 - 5 pz

## Nobilitato LEGNO / ALTATTO

pannello di particelle di legno spessore 18 mm idrofugo a basso contenuto di formaldeide nobilitato interno ed esterno con carta melaminica in finitura LEGNO riprodotto ad alta fedeltà o ALTATTO; bordo in ABS in finitura

high pressure layered laminate, a perfect and strong imitation of the natural wooden surface

stratifiés décoratifs haute pression. Plaques à base de résines thermodurcissables appelées stratifiés

Hochdruckmehrschichtlaminat mit einer dreidimensionalen Erscheinung

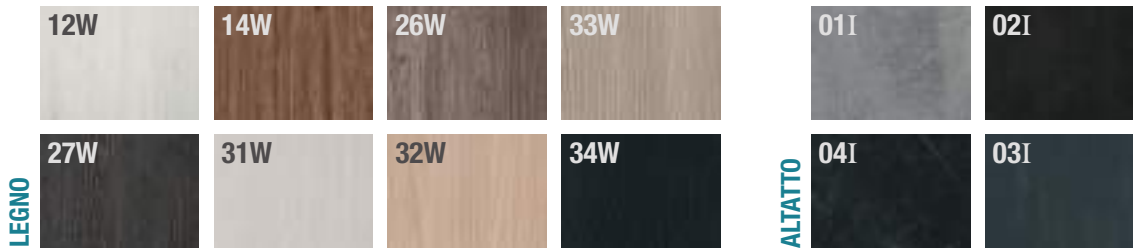

cod.	P	H	al cm lineare per linear cm au cm linéaire pro cm	+ prezzo foro lavabo + washbasin hole price + prix du trou pour vasque + Preis für Waschbeckenloch	
PSFA4506 PSFA5106	45 51,5	6 6			
PSFL4506 PSFL5106	45 51,5	6 6			
PSFA4510 PSFA5110	45 51,5	10 10			
PSFL4510 PSFL5110	45 51,5	10 10			
PSFA4515 PSFA5115	45 51,5	15 15			
PSFL4515 PSFL5115	45 51,5	15 15			

Staffa di sostegno - ordinare separatamente  
Brackets - order separately  
Supports - commander séparément  
Wandhalterungen - Separat bestellen

cod. OMZSTA06

< L 90 - 2 pz  
L 91 ÷ 130 - 3 pz  
L 131 ÷ 180 - 4 pz  
L 181 ÷ 210 - 5 pz

PIANO SOSPESO ACCOPPIATO







**Laccato OPACO / LUCIDO**  
**MATT / GLOSSY Lacquered**
**Laqué MAT / BRILLANT**  
**MATT / HOCHGLANZ Lackiert**

pannello di particelle di legno, idrofugo, a basso contenuto di formaldeide, verniciato con resine poliuretaniche pigmentate opache o lucide

wood particles panel 18 mm with low formaldehyde content, painted with polyurethane resins

panneaux de particules the bois 18 mm à faible teneur en formaldéhide, peint avec des résines de polyuréthane

Holzpartikelplatte 18 mm mit niedrigem Formaldehyd Gehalt, mit Polyurethanharzen lackiert



cod.	P	H	prezzo al cm lineare / per linear cm / au cm linéaire / pro cm		+ prezzo foro lavabo + washbasin hole price + prix du trou pour vasque + Preis für Waschbeckenloch	
			F1	F2		
PSFA4506	45	6				
PSFA5106	51,5	6				
PSFL4506	45	6				
PSFL5106	51,5	6				
PSFA4510	45	10				
PSFA5110	51,5	10				
PSFL4510	45	10				
PSFL5110	51,5	10				
PSFA4515	45	15				
PSFA5115	51,5	15				
PSFL4515	45	15				
PSFL5115	51,5	15				

Staffa di sostegno - ordinare separatamente  
 Brackets - order separately  
 Supports - commander séparément  
 Wandhalterungen - Separat bestellen

cod. OMZSTA06

< L 90 - 2 pz  
 L 91 ÷ 130 - 3 pz  
 L 131 ÷ 180 - 4 pz  
 L 181 ÷ 210 - 5 pz

### GRES accoppiato Coated GRES

materiale ceramico compatto con superficie estremamente resistente alle macchie, ai graffi e agli urti. Antibatterico e igienico. Accoppiato al piano Laccato OPACO/LUCIDO o Nobilitato LEGNO/ALTATTO

compact ceramic material with extremely resistant, decorated, and enamelled surface. Coupled with the top Laccato MATT/GLOSSY or Nobilitato LEGNO/ALTATTO

matériau céramique compact avec une surface décorée et émaillée extrêmement résistante. Couplé avec le plan Laccato MAT/BRILLANT ou Nobilitato LEGNO/ALTATTO

kompakter Keramikwerkstoff mit extrem widerstandsfähiger dekoriertes und emailierter Oberfläche. Verdoppelte mit Oberflächen Laccato MATT/HOCHGLANZ oder Nobilitato LEGNO/ALTATTO

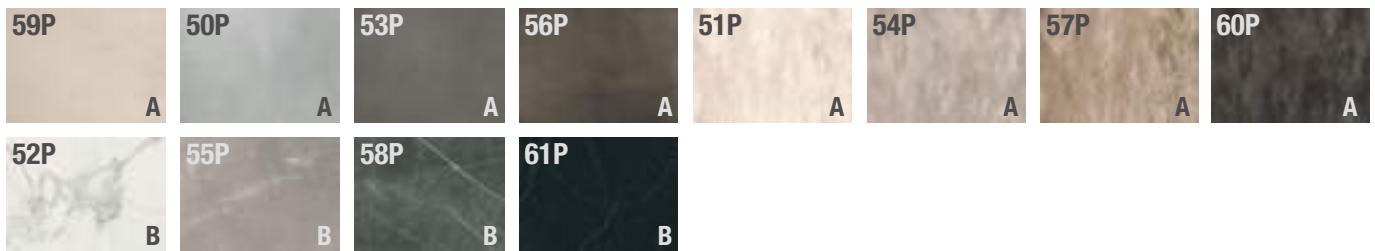

il piano in GRES H 0,6 cm va accoppiato al PIANO SOSPESO Nobilitato LEGNO, Nobilitato ALTATTO e Laccato OPACO/LUCIDO  
GRES H 0,6 cm must be coupled with free-standing tops Nobilitato LEGNO, Nobilitato ALTATTO and MATT/GLOSSY Lacquered  
GRES H0,6 cm doit être couplé avec un plan libre installaion en Nobilitato LEGNO, Nobilitato ALTATTO et MAT/BRILLANT Laqué  
GRES H 0,6 cm muss mit Freistehendeplatte verdoppelt werden

cod.	P	H	prezzo al cm lineare / per linear cm / au cm linéaire / pro cm		+ prezzo foro lavabo + washbasin hole price + prix du trou pour vasque + Preis für Waschbeckenloch	
			A	B		
PSGA4506	45	6,6				
PSGA5106	51,5	6,6				
PSGL4506	45	6,6				
PSGL5106	51,5	6,6				
PSGA4510	45	10,6				
PSGA5110	51,5	10,6				
PSGL4510	45	10,6				
PSGL5110	51,5	10,6				
PSGA4515	45	15,6				
PSGA5115	51,5	15,6				
PSGL4515	45	15,6				
PSGL5115	51,5	15,6				

i prezzi al cm lineare riportati nella tabella sono da intendersi per PIANO SOSPESO già accoppiato  
the prices per linear cm shown in the table are to be intended for the SUSPENDED FLOOR already coupled  
les prix au cm linéaire indiqués dans le tableau sont destinés au PLANCHER SUSPENDU déjà couplé  
Die in der Tabelle angegebenen Preise pro linearem cm gelten für den bereits gekoppelten SUSPENDED PLAN

Staffa di sostegno - ordinare separatamente  
Brackets - order separately  
Supports - commander séparément  
Wandhalterungen - Separat bestellen

cod. OMZSTA06

< L 90 - 2 pz  
L 91 ÷ 130 - 3 pz  
L 131 ÷ 180 - 4 pz  
L 181 ÷ 210 - 5 pz



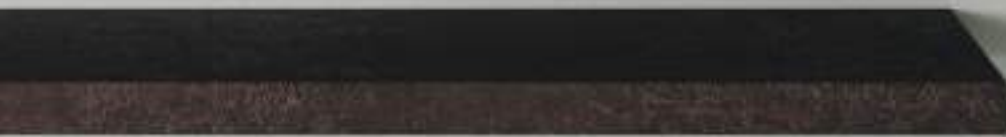

**AROCK®**

Filopiano lavabo integrato  
 Integrated plan washbasin  
 Vasque en plan intégrée  
 Integrierte Waschtischplatte

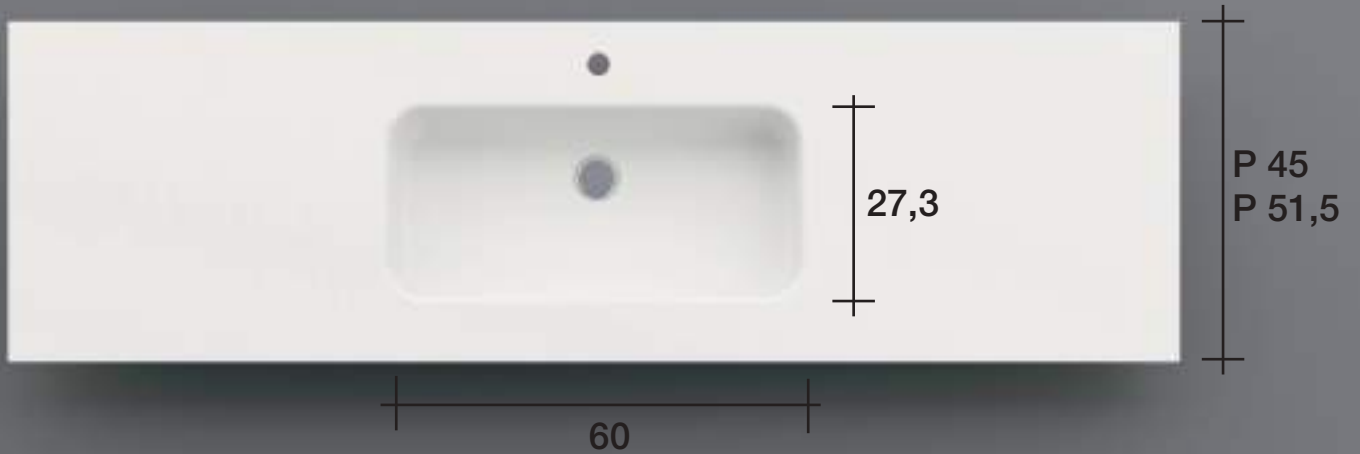

foro rubinetto incl.  
 tap hole incl.  
 trou pour le robinet incl.  
 Armaturbohrung inkl.

non provvisto di scarico troppopieno  
 without overflow system  
 sans système de trop-plein  
 ohne Überlaufsystem

kit piletta e sifone da ordinare separatamente  
 waste kit and siphon to be ordered separately  
 kit bonde d'évacuation et siphon à commander séparément  
 Ablauf Kit und Siphon müssen separat bestellt werden



AROCK®



H 6 / 10 / 15 cm - L max 210 cm

piano sospeso min L 60 cm - vasca L 42  
 piano sospeso min L 80 cm - vasca L 60

wall counter top min W 60 cm - integrated basin W 42  
 wall counter top min W 80 cm - integrated basin W 60

plan suspendu pour l'ameublement min L 60 cm - vasque L 42  
 plan suspendu pour l'ameublement min L 80 cm - vasque L 60

aufgehängte Platte fuer Einrichtung min B 60 cm - Becken B 42  
 aufgehängte Platte fuer Einrichtung min B 80 cm - Becken B 60

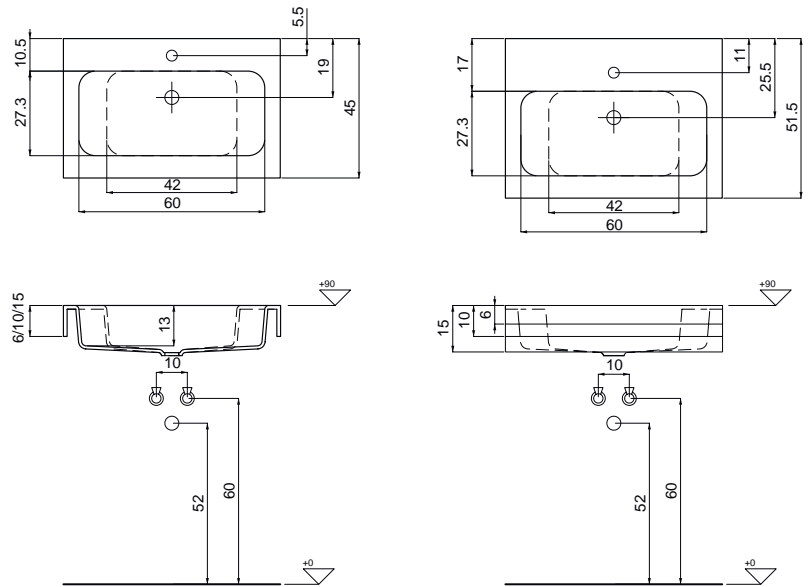

Per calcolare il prezzo totale del PIANO SOSPESO sommare al prezzo dei primi 50 cm il prezzo dei centimetri restanti

To calculate the total price of the freestanding top, add the price of the remaining cm to the price of the first 50 cm

Pour calculer le prix total de la console à libre installation, ajouter le prix du cm restant au prix des 50 premiers cm

Um den Gesamtpreis für den Freistehendeplatte zu berechnen, addieren Sie den Preis für die verbleibenden cm zum Preis für die ersten 50 cm

cod.	P	H	< 50 cm		
			vasca incl. nel prezzo basin price incl. prix du lavabo incl. Preis des Becken inkl.		prezzo seconda vasca additional basin price prix du lavabo supplémentaire Preis für das zusätzliche Becken
P5HI4506	45	6		6,5 €	
P5HI5106	51,5	6		6,5 €	
P5HI4510	45	10		7,0 €	
P5HI5110	51,5	10		7,0 €	
P5HI4515	45	15		7,5 €	
P5HI5115	51,5	15		7,5 €	
				al cm lineare per linear cm au cm linéaire pro cm	

Staffa di sostegno - ordinare separatamente  
 Brackets - order separately  
 Supports - commander séparément  
 Wandhalterungen - Separat bestellen

cod. OMZSTA06

< L 90 - 2 pz  
 L 91 ÷ 130 - 3 pz  
 L 131 ÷ 180 - 4 pz  
 L 181 ÷ 210 - 5 pz

**AROCK®**

Filopiano lavabo integrato  
Integrated plan washbasin  
Vasque en plan intégrée  
Integrierte Waschtischplatte

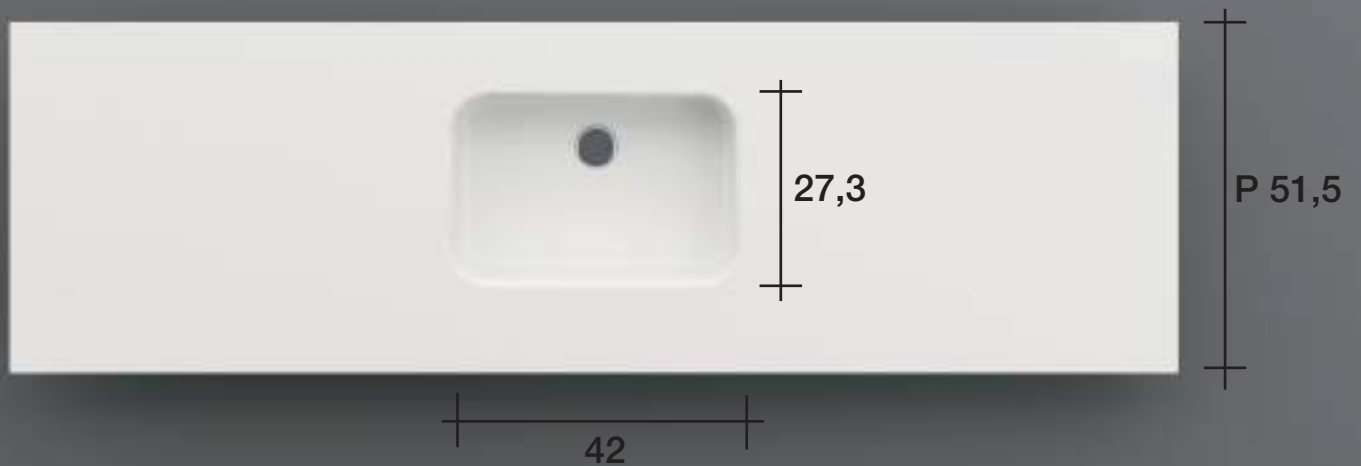
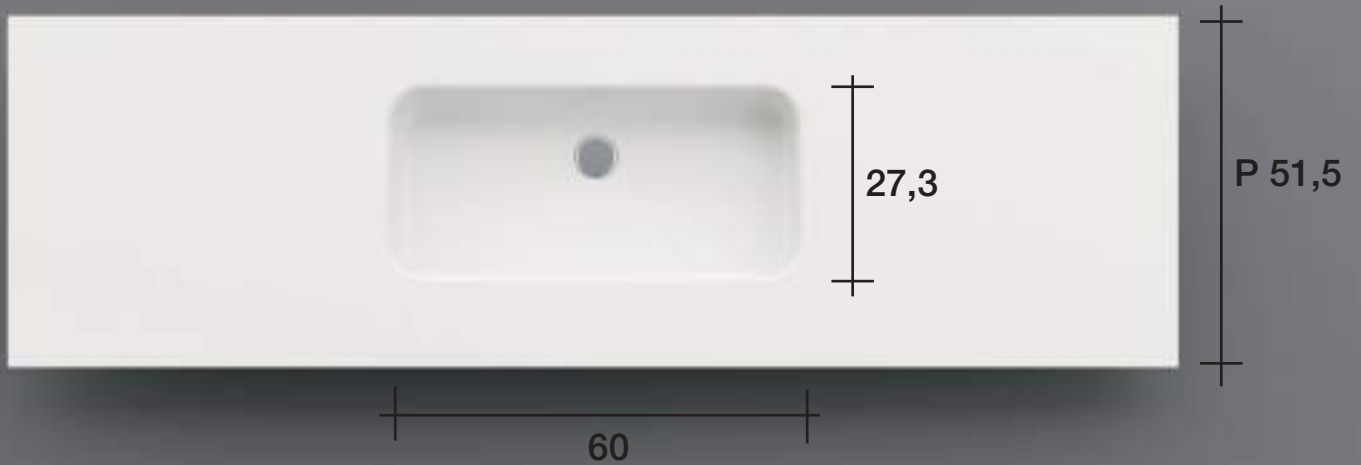

non provvisto di scarico troppopieno  
without overflow system  
sans système de trop-plein  
ohne Überlaufsystem

kit piletta e sifone da ordinare separatamente  
waste kit and siphon to be ordered separately  
kit bonde d'évacuation et siphon à commander séparément  
Ablauf Kit und Siphon müssen separat bestellt werden

AROCK®

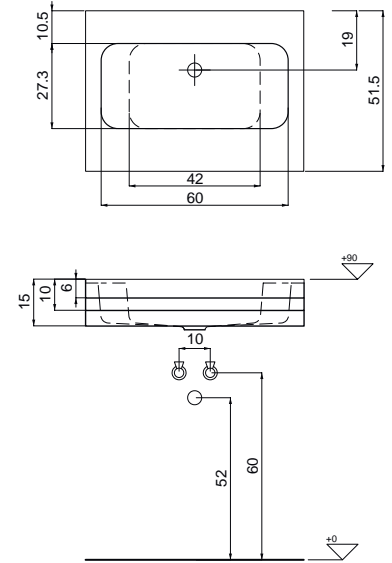
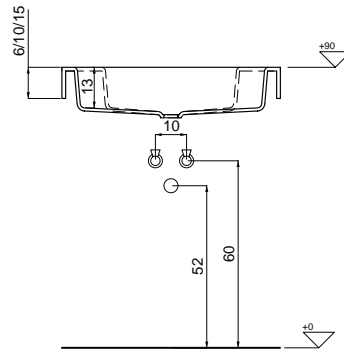

H 6 / 10 / 15 cm - L max 210 cm

base portalavabo min L 60 cm - vasca L 42  
base portalavabo min L 80 cm - vasca L 60washbasin unit min W 60 cm - integrated basin W 42  
washbasin unit min W 80 cm - integrated basin W 60meuble sous-vasque min L 60 cm - vasque L 42  
meuble sous-vasque min L 80 cm - vasque L 60Waschtischunterschrank min B 60 cm - Becken B 42  
Waschtischunterschrank min b 80 cm - Becken B 60

Per calcolare il prezzo totale del PIANO SOSPESO sommare al prezzo dei primi 50 cm il prezzo dei centimetri restanti

To calculate the total price of the freestanding top, add the price of the remaining cm to the price of the first 50 cm

Pour calculer le prix total de la console à libre installation, ajouter le prix du cm restant au prix des 50 premiers cm

Um den Gesamtpreis für den Freistehendeplatte zu berechnen, addieren Sie den Preis für die verbleibenden cm zum Preis für die ersten 50 cm

cod.	P	H	< 50 cm		
			vasca incl. nel prezzo basin price incl. prix du lavabo incl. Preis des Becken inkl.		prezzo seconda vasca additional basin price prix du lavabo supplémentaire Preis für das zusätzliche Becken
PSHV5106	51,5	6			
PSHV5110	51,5	10			
PSHV5115	51,5	15			
				al cm lineare per linear cm au cm linéaire pro cm	

Staffa di sostegno - ordinare separatamente  
Brackets - order separately  
Supports - commander séparément  
Wandhalterungen - Separat bestellen

cod. OMZSTA06

< L 90 - 2 pz  
L 91 ÷ 130 - 3 pz  
L 131 ÷ 180 - 4 pz  
L 181 ÷ 210 - 5 pz



Il Machu Picchu - Vecchia Montagna (scavi iniziati nel 1911) è un sito archeologico Inca situato in Perù nella valle dell'Urubamba a 2430 m s. l. m. Universalmente riconosciuto per le sue imponenti rovine e per l'impressionante vista che si ha sulla valle sottostante. Fa parte dei patrimoni dell'umanità stilati dall'UNESCO ed è stato eletto nel 2007 una delle Sette Meraviglie del Mondo Moderno





Machu Picchu (Old Mountain) is an Inca archaeological site located in Perù, precisely, in the valley of Urubamba 2430 m above sea level, where the excavations took place in 1911. Machu Picchu is, universally, recognized thanks to both its massive ruins and impressive views that is visible from the valley underneath. It is included in the heritage of the humanity drawn up by UNESCO. In addition, in 2007, Machu Picchu was elected one of the Modern World's Seven Wonders.



SHAMBOLA® CONSOLE PER LAVAO CON TAVOLO ALCENTIMETRO







**A** piano / top / plan / Platte

TIPOLOGIE:  
filopiano lavabo integrato;  
per lavabo sopra piano da appoggio e  
da incasso  
PROFONDITA': 45-51,5 cm  
FINITURE: Arock® - HPL - Nobilitato  
LEGNO/ALTATTO - Laccato OPACO/  
LUCIDO - GRES - PIETRA NATURALE -  
SILESTONE

TYPES:  
integrated plan washbasin;  
for countertop basin, recessed basin  
DEPTH: 45-51.5 cm  
FINISHES: Arock® - HPL - Nobilitato  
LEGNO/ALTATTO - Laquered OPACO/  
LUCIDO - GRES - PIETRA NATURALE -  
SILESTONE

TIPOLOGIES:  
lavabo intégré au plan;  
pour lavabo à poser, lavabo encastré  
surélevé  
PROFONDEUR: 45-51,5 cm  
FINITIONS: Arock® - HPL - Mé laminé  
BOIS/ALTATTO - Laque MAT/BRIL-  
LANT - GRES - PIERRE NATURELLE  
- SILESTONE

TIPOLOGIEN:  
integriertes Waschbecken;  
für Aufsatzwaschtisch, Halbeinbau-  
becken  
TIEFE: 45-51,5 cm  
AUSFÜHRUNGEN: Arock® - HPL -  
Melamin HOLZ/ALTATTO - MATT/HO-  
CHGLANZ Lack - GRES - NATURSTEIN  
- SILESTONE

**B** struttura / structure / structure / Struktur

struttura in alluminio anodizzato con  
gambe frontali e ripiano  
portasalviette laterale FACOLTATIVO  
ALTEZZA: 74-89 cm  
PROFONDITA': 45-51,5 cm  
LARGHEZZA: min 50 / max 210 cm  
FINITURE: vogue/abitat & 48 colori.02

anodized aluminum structure with  
front legs and one shelf  
side towel holder OPTIONAL  
HEIGHT: 74-89 cm  
DEPTH: 45-51,5 cm  
WIDTH: min 50 / max 210 cm  
FINISHES: vogue/abitat & 48 colori.02

structure en aluminium anodisé avec  
pieds et un étagère  
porte-serviettes latéral EN OPTION  
HAUTEUR: 74-89 cm  
PROFONDEUR: 45-51,5 cm  
LARGEUR: min 50 / max 210 cm  
FINITIONS: vogue/abitat & 48 colori.02

eloxierte Aluminiumstruktur mit  
Vorderbeinen und ein Regal  
seitlicher Handtuchhalter OPTIONAL  
HÖHE: 74-89 cm  
TIEFE: 45-51,5 cm  
BREITE: min 50 / max 210 cm  
AUSFÜHRUNGEN: vogue/abitat & 48  
colori.02

**C** ripiano / shelf / étagère / Regal

ripiano fissato in posizione predefinita  
a 25 cm da terra  
FINITURE: Arock® - HPL - Nobilitato  
LEGNO/ALTATTO - Laccato OPACO/  
LUCIDO - GRES - PIETRA NATURALE -  
SILESTONE

shelf fixed in a defined position at 25  
cm from the floor  
FINISHES: Arock® - HPL - Nobilitato  
LEGNO/ALTATTO - MATT/GLOSSY Lac-  
quered - GRES - PIETRA NATURALE  
- SILESTONE

étagère fixée en une position définie à  
25 cm du sol  
FINITIONS: Arock® - HPL - Mé laminé  
BOIS/ALTATTO - Laque MAT/BRIL-  
LANT - GRES - PIERRE NATURELLE  
- SILESTONE

Regal in Standardposition 25 cm über  
dem Boden befestigt fixed  
AUSFÜHRUNGEN: Arock® - HPL -  
Melamin HOLZ/ALTATTO - MATT/HO-  
CHGLANZ Lack - GRES - NATURSTEIN  
- SILESTONE

FILOPIANO LAVABI INTEGRATI PER MOBILI  
PIANI PER MOBILI

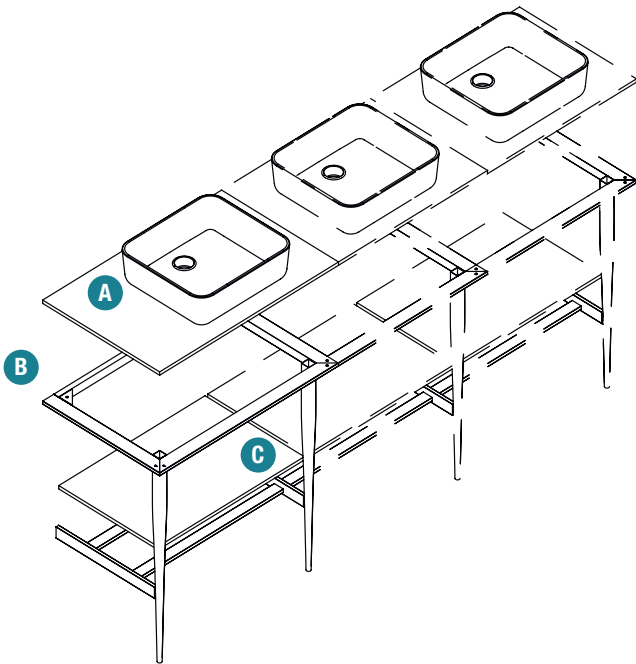
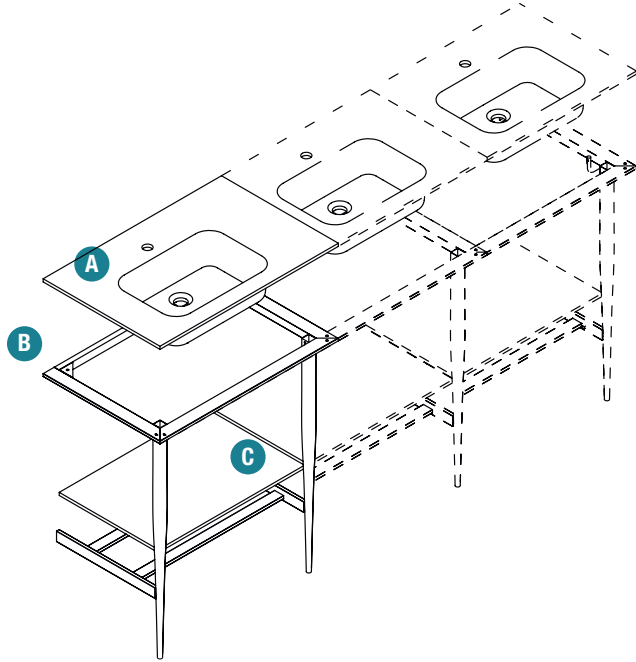

**A** piano / top / plan / Platte

TIPOLOGIE:  
filopiano lavabo integrato;  
per lavabo sopra piano da appoggio e  
da incasso  
PROFONDITA': 45-51,5 cm  
FINITURE: Arock® - HPL - Nobilitato  
LEGNO/ALTATTO - Laccato OPACO/  
LUCIDO - GRES - PIETRA NATURALE -  
SILESTONE

TYPES:  
integrated plan washbasin;  
for countertop basin, recessed basin  
DEPTH: 45-51.5 cm  
FINISHES: Arock® - HPL - Nobilitato  
LEGNO/ALTATTO - Laquered OPACO/  
LUCIDO - GRES - PIETRA NATURALE -  
SILESTONE

TIPOLOGIES:  
lavabo intégré au plan;  
pour lavabo à poser, lavabo encastré  
surélevé  
PROFONDEUR: 45-51,5 cm  
FINITIONS: Arock® - HPL - Mé laminé  
BOIS/ALTATTO - Laque MAT/BRIL-  
LANT - GRES - PIERRE NATURELLE  
- SILESTONE

TIPOLOGIEN:  
integriertes Waschbecken;  
für Aufsatzwaschtisch, Halbeinbau-  
becken  
TIEFE: 45-51,5 cm  
AUSFÜHRUNGEN: Arock® - HPL -  
Melamin HOLZ/ALTATTO - MATT/HO-  
CHGLANZ Lack - GRES - NATURSTEIN  
- SILESTONE

**B** struttura / structure / structure / Struktur

struttura in alluminio anodizzato con  
gambe frontali e ripiano  
portasalviette laterale FACOLTATIVO  
ALTEZZA: 74-89 cm  
PROFONDITA': 45-51,5 cm  
LARGHEZZA: min 50 / max 210 cm  
FINITURE: vogue/abitat & 48 colori.02

anodized aluminum structure with  
front legs and one shelf  
side towel holder OPTIONAL  
HEIGHT: 74-89 cm  
DEPTH: 45-51,5 cm  
WIDTH: min 50 / max 210 cm  
FINISHES: vogue/abitat & 48 colori.02

structure en aluminium anodisé avec  
pieds et un étagère  
porte-serviettes latéral EN OPTION  
HAUTEUR: 74-89 cm  
PROFONDEUR: 45-51,5 cm  
LARGEUR: min 50 / max 210 cm  
FINITIONS: vogue/abitat & 48 colori.02

eloxierte Aluminiumstruktur mit  
Vorderbeinen und ein Regal  
seitlicher Handtuchhalter OPTIONAL  
HÖHE: 74-89 cm  
TIEFE: 45-51,5 cm  
BREITE: min 50 / max 210 cm  
AUSFÜHRUNGEN: vogue/abitat & 48  
colori.02

**C** ripiano / shelf / étagère / Regal

ripiano fissato in posizione predefinita  
a 25 cm da terra  
FINITURE: Arock® - HPL - Nobilitato  
LEGNO/ALTATTO - Laccato OPACO/  
LUCIDO - GRES - PIETRA NATURALE -  
SILESTONE

shelf fixed in a defined position at 25  
cm from the floor  
FINISHES: Arock® - HPL - Nobilitato  
LEGNO/ALTATTO - MATT/GLOSSY Lac-  
quered - GRES - PIETRA NATURALE  
- SILESTONE

étagère fixée en une position définie à  
25 cm du sol  
FINITIONS: Arock® - HPL - Mé laminé  
BOIS / ALTATTO - Laque MAT / BRIL-  
LANT - GRES - PIERRE NATURELLE  
- SILESTONE

Regal in Standardposition 25 cm über  
dem Boden befestigt fixed  
AUSFÜHRUNGEN: Arock® - HPL -  
Melamin HOLZ / ALTATTO - MATT/HO-  
CHGLANZ Lack - GRES - NATURSTEIN  
- SILESTONE

FILOPIANO LAVABI INTEGRATI PER MOBILI  
PIANI PER MOBILI

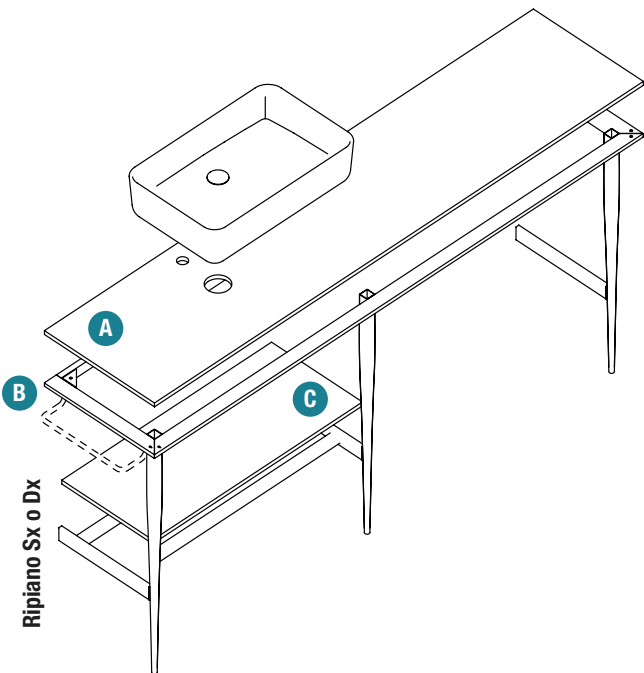
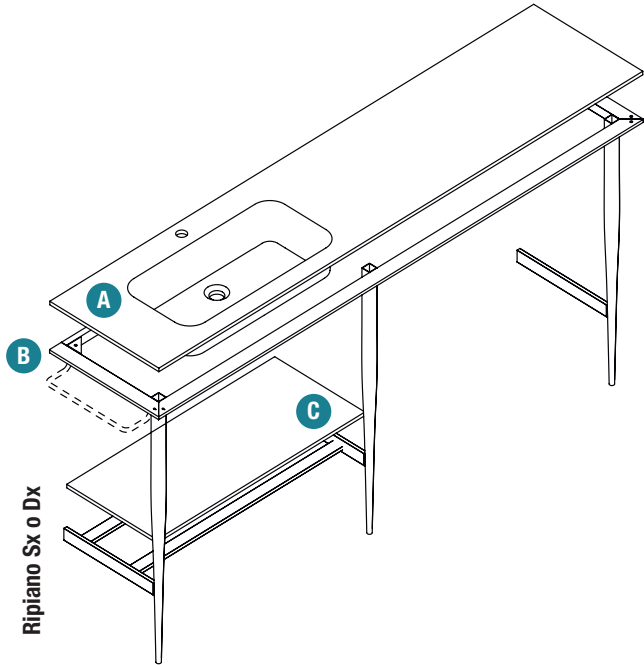

abitat / vogue

Arock® & laccato OPACO  
 Arock® & MATT lacquered  
 Arock® & laqué MAT  
 Arock® & MATT Lackiert

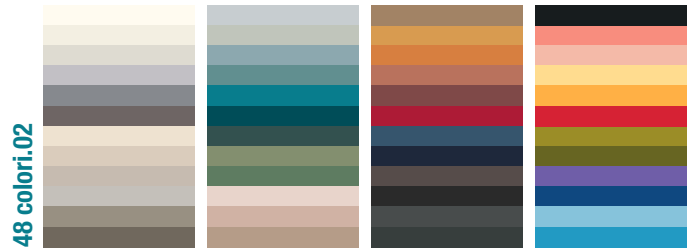
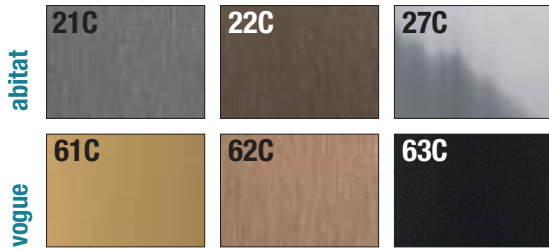

Modularità  
 Modularity

Modularité  
 Modularität

SHAMBOLA® di PAOLO SALVADÉ

CONSOLE PER LAVABO

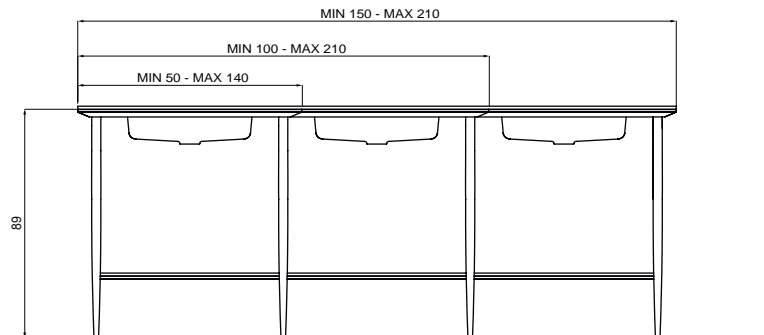

SHAMBOLA® di PAOLO SALVADÉ

CONSOLE PER LAVABO CON TAVOLO

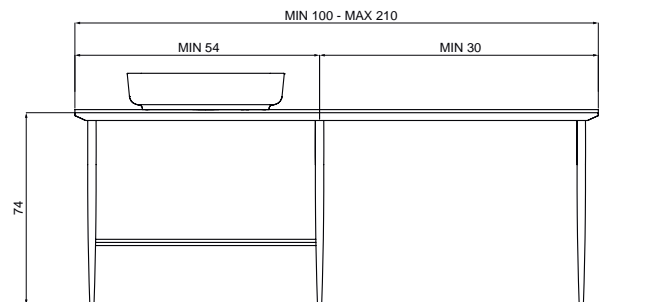
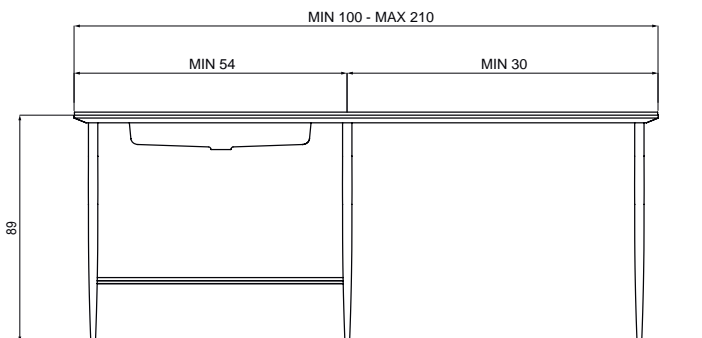

i colori qui riportati sono da considerarsi indicativi  
the colours can diverge from the reality  
la fidélité des couleurs peut être différent de la réalité  
bitte berücksichtigen Sie unsere Farbfächer zur Farbauswahl

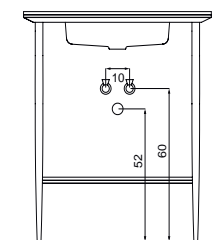
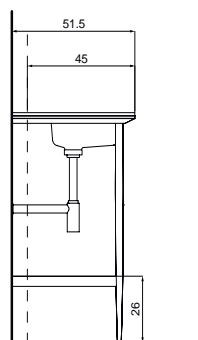
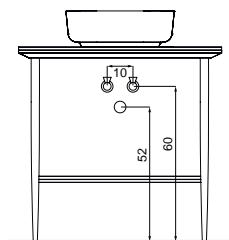
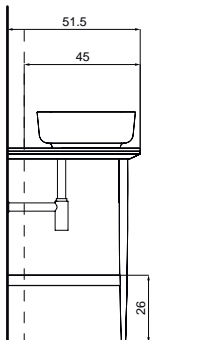
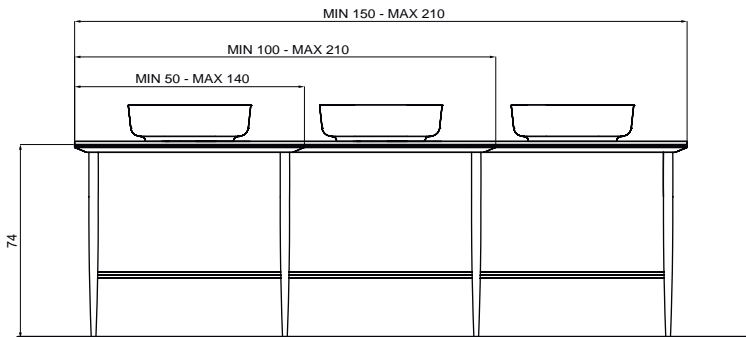







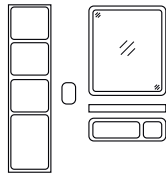
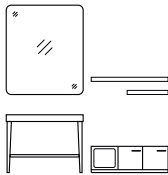
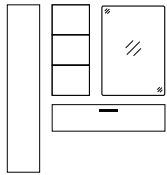
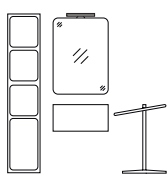

# Shambola® CONSOLE PER LAVABO

				
UNICAMENTE AROCK®	ALCENTIMETRO PROGETTO	Elementi CONTENITORI	Elementi COMPLEMENTARI	RICAMBI
34	98	180	226	592

calcolo del prezzo totale: (valore **S**) + (prezzo al cm lineare x **L** totale)  
 total price calculation: (**S** value) + (price per linear cm x total **L**)  
 calcul du prix total : (valeur **S**) + (prix au cm linéaire x **L** total)  
 Berechnung des Gesamtpreises: (**S**-Wert) + (Preis pro cm x Gesamt-**L**)

## H 74

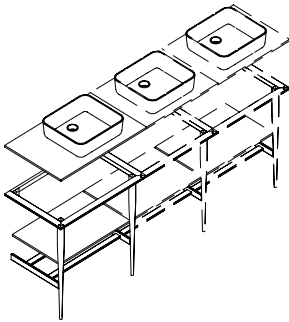

## P 45

Struttura  
Structure  
Structure  
Struktur

L	S	F1	F5
50÷140 2 gambe CLC00120			
100÷210 3 gambe CLC00130			
150÷210 4 gambe CLC00140			

al cm lineare  
per linear cm  
au cm linéaire  
pro linearem cm

## P 51,5

L	S	F1	F5
50÷140 2 gambe CLD00120			
100÷210 3 gambe CLD00130			
150÷210 4 gambe CLD00140			

al cm lineare  
per linear cm  
au cm linéaire  
pro linearem cm

## H 89

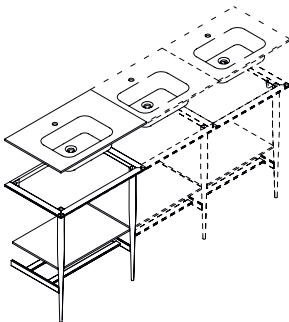

## P 45

Struttura  
Structure  
Structure  
Struktur

L	S	F1	F5
50÷140 2 gambe CLA00120			
100÷210 3 gambe CLA00130			
150÷210 4 gambe CLA00140			

al cm lineare  
per linear cm  
au cm linéaire  
pro linearem cm

## P 51,5

L	S	F1	F5
50÷140 2 gambe CLB00120			
100÷210 3 gambe CLB00130			
150÷210 4 gambe CLB00140			

al cm lineare  
per linear cm  
au cm linéaire  
pro linearem cm



## P 7

Portasalviette per console - FACOLTATIVO  
 Console towel holder - OPTIONAL  
 Porte-serviettes à console - OPTIONNEL  
 Handtuchhalter für Konsole Struktur stehend - OPTIONAL

L	F1	F5
34,5 OMASAL02		



Misure in cm  
Measures in cm  
Mesures en cm  
Maße in cm

**F1** Laccato opaco  
Matt lacquered  
Laqué mat  
Matt lackiert



**F2** Laccato lucido  
Glossy lacquered  
Laqué brillant  
Hochglanz lackiert

**F3** Nobilitati  
Veneer wood  
Placage bois  
Beschichtetes Holz

**F4** Arock®  
Arock®  
Arock®  
Arock®

**F5** abitat / vogue  
abitat / vogue  
abitat / vogue  
abitat / vogue

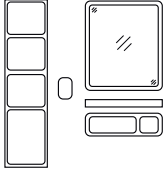
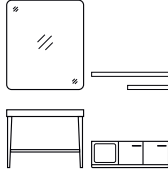
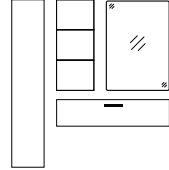
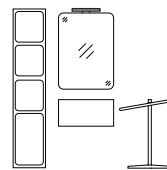
# Shambola® CONSOLE PER LAVABO CON TAVOLO

				
UNICAMENTE AROCK®	ALCENTIMETRO PROGETTO	Elementi CONTENITORI	Elementi COMPLEMENTARI	RICAMBI
34	98	180	226	592

calcolo del prezzo totale: (valore **S**) + (prezzo al cm lineare x **L** totale)

total price calculation: (**S** value) + (price per linear cm x total **L**)

calcul du prix total : (valeur **S**) + (prix au cm linéaire x **L** total)

Berechnung des Gesamtpreises: (**S**-Wert) + (Preis pro cm x Gesamt-**L**)

## H 74

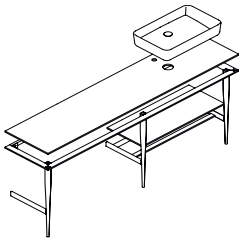

## P 45

Struttura dx • 3 gambe  
Structure • 3 legs  
Structure • 3 pieds  
Struktur • 3 Füße

**L** 100÷210 **CLC00132** **S** **F1** **F5**

al cm lineare  
per linear cm  
au cm linéaire  
pro linearem cm

## P 51,5

**L** 100÷210 **CLD00132** **S** **F1** **F5**

al cm lineare  
per linear cm  
au cm linéaire  
pro linearem cm

## H 74

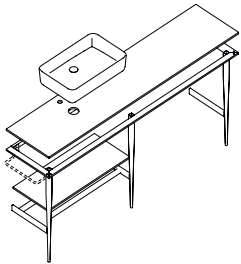

## P 45

Struttura sx • 3 gambe  
Structure • 3 legs  
Structure • 3 pieds  
Struktur • 3 Füße

**L** 100÷210 **CLC00133** **S** **F1** **F5**

al cm lineare  
per linear cm  
au cm linéaire  
pro linearem cm

## P 51,5

**L** 100÷210 **CLD00133** **S** **F1** **F5**

al cm lineare  
per linear cm  
au cm linéaire  
pro linearem cm

## H 89

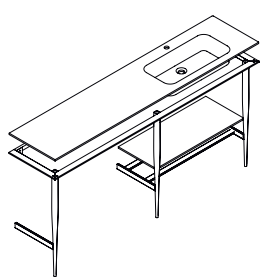

## P 45

Struttura dx • 3 gambe  
Structure • 3 legs  
Structure • 3 pieds  
Struktur • 3 Füße

**L** 100÷210 **CLA00132** **S** **F1** **F5**

al cm lineare  
per linear cm  
au cm linéaire  
pro linearem cm

## P 51,5

**L** 100÷210 **CLB00132** **S** **F1** **F5**

al cm lineare  
per linear cm  
au cm linéaire  
pro linearem cm

## H 89

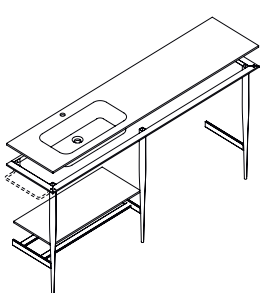

## P 45

Struttura sx • 3 gambe  
Structure • 3 legs  
Structure • 3 pieds  
Struktur • 3 Füße

**L** 100÷210 **CLA00133** **S** **F1** **F5**

al cm lineare  
per linear cm  
au cm linéaire  
pro linearem cm

## P 51,5

**L** 100÷210 **CLB00133** **S** **F1** **F5**

al cm lineare  
per linear cm  
au cm linéaire  
pro linearem cm

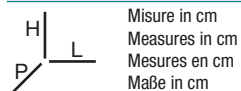

Misure in cm  
Measures in cm  
Mesures en cm  
Maße in cm

**F1** Laccato opaco  
Matt lacquered  
Laqué mat  
Matt lackiert

**F2** Laccato lucido  
Glossy lacquered  
Laqué brillant  
Hochglanz lackiert

**F3** Nobilitati  
Veneer wood  
Placage bois  
Beschichtetes Holz

**F4** Arock®  
Arock®  
Arock®  
Arock®

**F5** abitat / vogue  
abitat / vogue  
abitat / vogue  
abitat / vogue









**A** piano / top / plan / Platte

<p>TIPOLOGIE: per basi d'arredo PROFONDITA': 45-51,5 cm FINITURE: Arock® - HPL - Nobilitato LEGNO/ALTATTO - Laccato OPACO/ LUCIDO - GRES - PIETRA NATURALE - SILESTONE</p>	<p>TYPES: for furnishing units DEPTH: 45-51.5 cm FINISHES: Arock® - HPL - Nobilitato LEGNO/ALTATTO - Laquered OPACO/ LUCIDO - GRES - PIETRA NATURALE - SILESTONE</p>	<p>TIPOLOGIES: lavabo intégré au plan; pour lavabo à poser, lavabo encastré surélevé et lavabo encastré PROFONDEUR: 45-51,5 cm FINITIONS: Arock® - HPL - Mélaminé BOIS/ALTATTO - Laque MAT/BRIL- LANT - GRES - PIERRE NATURELLE - SILESTONE</p>	<p>TIPOLOGIEN: integriertes Waschbecken; für Aufsatzwaschtisch, Halbeinbau- becken und Einbauwaschtisch TIEFE: 45-51,5 cm AUSFÜHRUNGEN: Arock® - HPL - Melamin HOLZ/ALTATTO - MATT/HO- CHGLANZ Lack - GRES - NATURSTEIN - SILESTONE</p>
--	--	---	---

**B** struttura / structure / structure / Struktur

<p>struttura in alluminio anodizzato con gambe frontali e ripiano ALTEZZA: 74-89 cm PROFONDITA': 45-51,5 cm LARGHEZZA: min 100 / max 210 cm FINITURE: vogue/abitat &amp; 48 colori.02</p>	<p>anodized aluminum structure with front legs and one shelf side towel holder OPTIONAL HEIGHT: 74-89 cm DEPTH: 45-51,5 cm WIDTH: min 54 / max 210 cm FINISHES: vogue/abitat &amp; 48 colori.02</p>	<p>structure en aluminium anodisé avec pieds et un étagère HAUTEUR: 74-89 cm PROFONDEUR: 45-51,5 cm LARGEUR: min 54 / max 210 cm FINITIONS: vogue/abitat &amp; 48 colori.02</p>	<p>eloxierte Aluminiumstruktur mit Vorderbeinen und ein Regal HÖHE: 74-89 cm TIEFE: 45-51,5 cm BREITE: min 54 / max 210 cm AUSFÜHRUNGEN: vogue/abitat &amp; 48 colori.02</p>
---	---	---	--

**C** ripiano / shelf / étagère / Regal

<p>ripiano fissato in posizione predefinita a 25 cm da terra FINITURE: Arock® - HPL - Nobilitato LEGNO/ALTATTO - Laccato OPACO/ LUCIDO - GRES - PIETRA NATURALE - SILESTONE</p>	<p>shelf fixed in a defined position at 25 cm from the floor FINISHES: Arock® - HPL - Nobilitato LEGNO/ALTATTO - MATT/GLOSSY Lac- quered - GRES - PIETRA NATURALE - SILESTONE</p>	<p>étagère fixée en une position définie à 25 cm du sol FINITIONS: Arock® - HPL - Mélaminé BOIS/ALTATTO - Laque MAT/BRIL- LANT - GRES - PIERRE NATURELLE - SILESTONE</p>	<p>Regal in Standardposition 25 cm über dem Boden befestigt fixed AUSFÜHRUNGEN: Arock® - HPL - Melamin HOLZ/ALTATTO - MATT/HO- CHGLANZ Lack - GRES - NATURSTEIN - SILESTONE</p>
---	---	--	---

PIANI PER BASI D'ARREDO

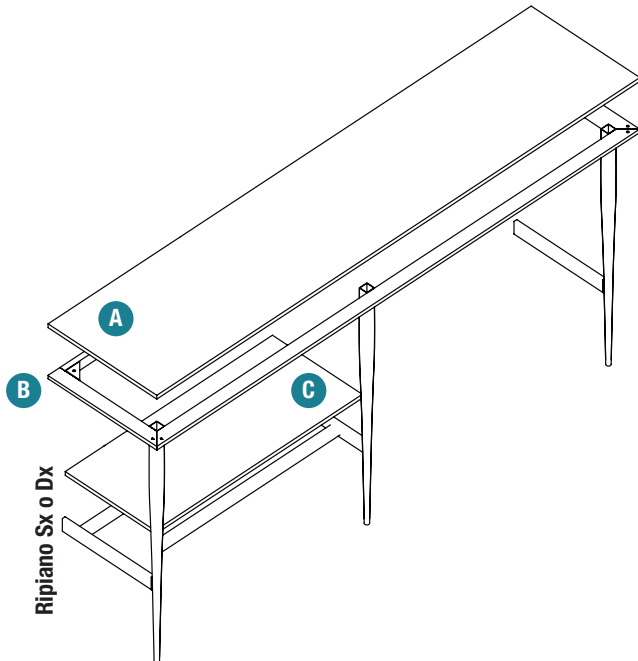

SHAMBOLA®

CONSOLE PER TAVOLO

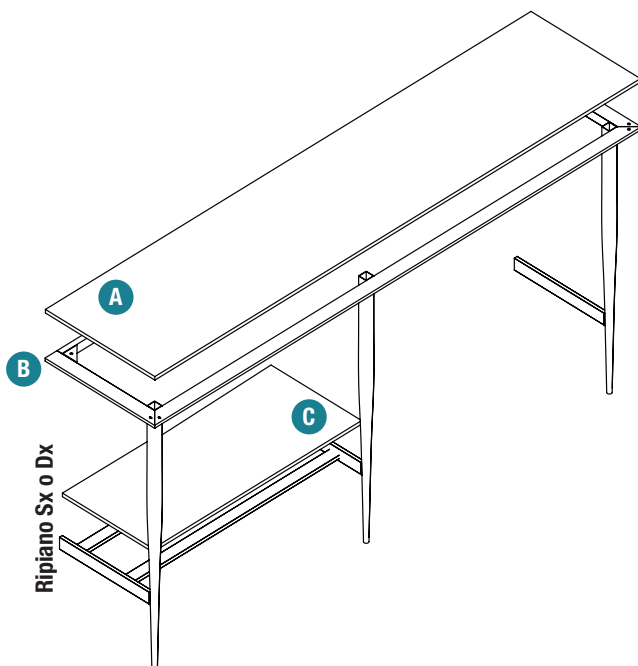

SHAMBOLA®

CONSOLE PER TAVOLO DA INGRESSO

## abitat / vogue

Arock® & laccato OPACO  
 Arock® & MATT lacquered  
 Arock® & laqué MAT  
 Arock® & MATT Lackiert

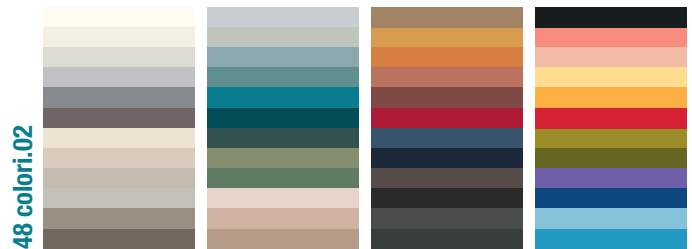

Modularità  
 Modularity

Modularité  
 Modularität

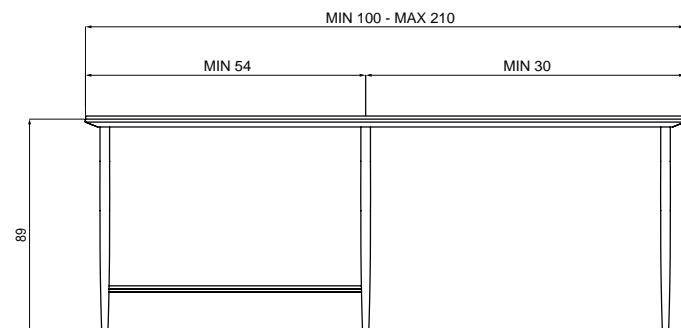
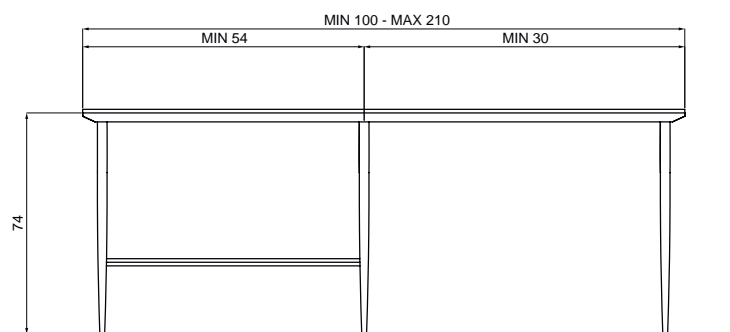



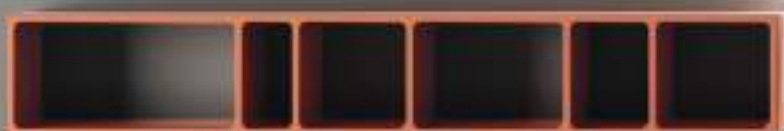

i colori qui riportati sono da considerarsi indicativi  
the colours can diverge from the reality  
la fidélité des couleurs peut être différent de la réalité  
bitte berücksichtigen Sie unsere Farbfächer zur Farbauswahl

---



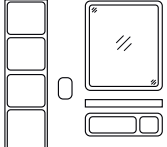

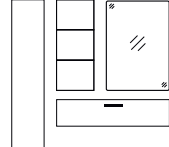
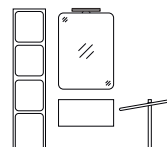
# Shambola® CONSOLE PER TAVOLO E TAVOLO DA INGRESSO

				
UNICAMENTE AROCK®	ALCENTIMETRO PROGETTO	Elementi CONTENITORI	Elementi COMPLEMENTARI	RICAMBI
34	98	180	226	592

calcolo del prezzo totale: (valore **S**) + (prezzo al cm lineare x **L** totale)

total price calculation: (**S** value) + (price per linear cm x total **L**)

calcul du prix total : (valeur **S**) + (prix au cm linéaire x **L** total)

Berechnung des Gesamtpreises: (**S**-Wert) + (Preis pro cm x Gesamt-L)

## H 74

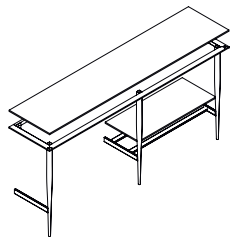

### P 45

Struttura dx • 3 gambe  
Structure • 3 legs  
Structure • 3 pieds  
Struktur • 3 Füße

**L** **S** **F1** **F5**  
100÷210 CLC00132

al cm lineare  
per linear cm  
au cm linéaire  
pro linearem cm

### P 51,5

**L** **S** **F1** **F5**  
100÷210 CLD00132

al cm lineare  
per linear cm  
au cm linéaire  
pro linearem cm

## H 74

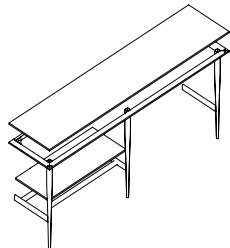

### P 45

Struttura dx • 3 gambe  
Structure • 3 legs  
Structure • 3 pieds  
Struktur • 3 Füße

**L** **S** **F1** **F5**  
100÷210 CLC00133

al cm lineare  
per linear cm  
au cm linéaire  
pro linearem cm

### P 51,5

**L** **S** **F1** **F5**  
100÷210 CLD00133

al cm lineare  
per linear cm  
au cm linéaire  
pro linearem cm

## H 89

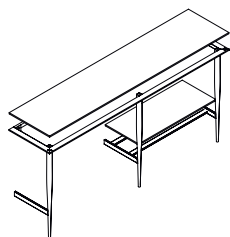

### P 45

Struttura dx • 3 gambe  
Structure • 3 legs  
Structure • 3 pieds  
Struktur • 3 Füße

**L** **S** **F1** **F5**  
100÷210 CLA00132

al cm lineare  
per linear cm  
au cm linéaire  
pro linearem cm

### P 51,5

**L** **S** **F1** **F5**  
100÷210 CLB00132

al cm lineare  
per linear cm  
au cm linéaire  
pro linearem cm

## H 89

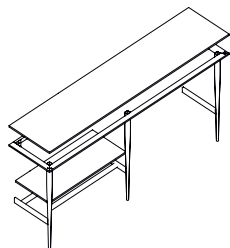

### P 45

Struttura dx • 3 gambe  
Structure • 3 legs  
Structure • 3 pieds  
Struktur • 3 Füße

**L** **S** **F1** **F5**  
100÷210 CLA00133

al cm lineare  
per linear cm  
au cm linéaire  
pro linearem cm

### P 51,5

**L** **S** **F1** **F5**  
100÷210 CLB00133

al cm lineare  
per linear cm  
au cm linéaire  
pro linearem cm

 Misure in cm  
Measures in cm  
Mesures en cm  
Maße in cm

**F1** Laccato opaco  
Matt lacquered  
Laqué mat  
Matt lackiert

**F2** Laccato lucido  
Glossy lacquered  
Laqué brillant  
Hochglanz lackiert

**F3** Nobilitati  
Veneer wood  
Placage bois  
Beschichtetes Holz

**F4** Arock®  
Arock®  
Arock®  
Arock®

**F5** abitat / vogue  
abitat / vogue  
abitat / vogue  
abitat / vogue





**come calcolare il prezzo**  
**how to calculate the price**

**comment calculer le prix**  
**wie berechnet man den Preis**

1. scegliere la tipologia di lavabo desiderato  
choose your type of basin  
choisissez le type de lavabo que vous préférez  
wählen Sie den gewünschten Becken
2. verificare la profondità necessaria del piano per l'installazione del lavabo scelto  
check the depth of the top needed to install your basin  
vérifier la profondeur du plan nécessaire pour installer le lavabo choisi  
überprüfen Sie die Tiefe der Platte, der für die Installation der Becken erforderlich ist
3. stabilire il materiale e la lunghezza del piano  
decide material and length of the top  
établir le matériau et la longueur du plan  
stellen Sie das Material und die Länge der Platte fest
4. calcolare il prezzo totale usando la tabella al cm lineare del piano scelto  
calculate the total price using the cost per cm of the chosen top  
calculer le prix total en utilisant le cout linéaire par cm du plan choisi  
berechnen Sie den Gesamtpreis anhand der linearen Kosten in cm des gewählten Plans
5. aggiungere il prezzo di eventuali variabili in tabella  
add the price of any variables to be found in the table  
ajouter le prix des variables dans le tableau  
addieren Sie den Preis aller Variablen in der Tabelle

**attenzione - note**  
**attention - notes**

**attention - notes**  
**achtung - Notizen**

i fori per la rubinetteria NON prevedono sovrapprezzo  
NO extra costs for tap holes  
PAS frais supplémentaires pour les trous de robinetterie  
KEINE zusätzlichen Kosten fuer Waschenbeckenlöcher

i piani di misura inferiore alla L minima indicata, NON sono realizzabili  
NO smaller size than the one indicated for the top  
PAS la mesure inférieure au minimum indiqué pour plan  
KEIN Plan niedriger als das angegebene Minimum

per le lavorazioni a smusso e per i cambi di profondità, inviare sempre la richiesta all'ufficio tecnico TDA  
for bevel cuts and depth changing please contact TDA technical office  
pour changement de profondeur et coupe en biseau, contacter le bureau technique TDA  
für abgeschrägter Schnitt und Änderung der Tiefe, wenden Sie sich an das technische Büro von TDA

i piani con dima e/o disegno tecnico, hanno un sovrapprezzo di **300 €**  
**300 €** extra cost for tops with template or technical drawing  
extra cost for tops with template or technical drawing **300 €**  
Platte mit Vorlage oder technischer Zeichnung haben einen Aufpreis von **300 €**

• la scheda tecnica di un lavabo non presente nel nostro listino è indispensabile per la produzione del piano  
the technical data sheet of a washbasin not indicated in our price list is essential for the production of the top  
la fiche technique d'une vasque non présente dans notre tarif est indispensable pour la réalisation du plan  
das technische Datenblatt eines Becken, das nicht in unserer Preisliste enthalten ist, ist für die Herstellung des Tops zwingend erforderlich

**AROCK®**

Filopiano lavabo integrato  
 Integrated plan washbasin  
 Vasque en plan intégrée  
 Integrierte Waschtischplatte

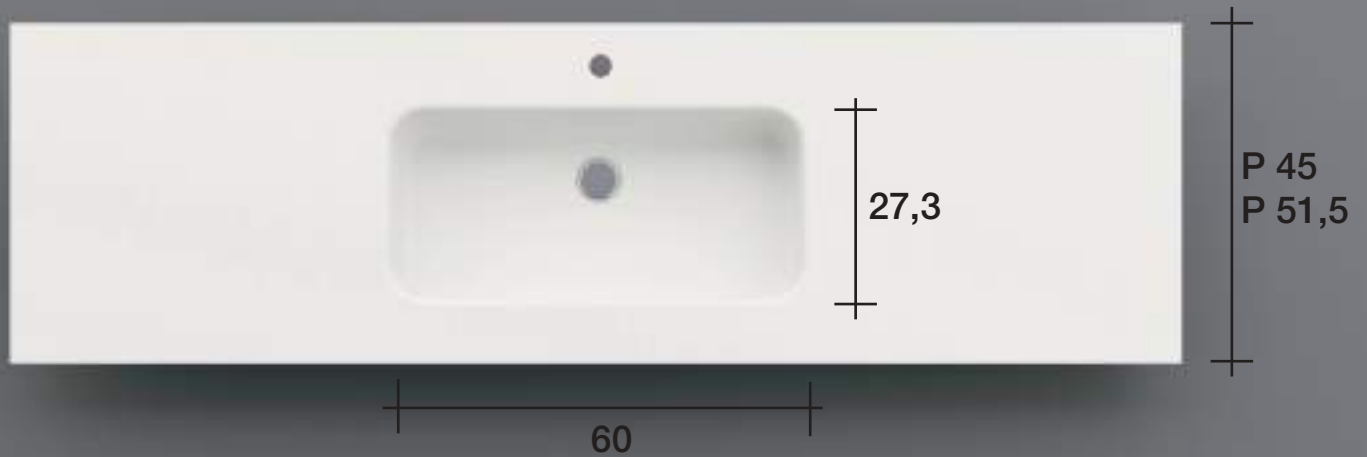

foro rubinetto incl.  
 tap hole incl.  
 trou pour le robinet incl.  
 Armaturbohrung inkl.

non provisto di scarico troppopieno  
 without overflow system  
 sans système de trop-plein  
 ohne Überlaufsystem

kit piletta e sifone da ordinare separatamente  
 waste kit and siphon to be ordered separately  
 kit bonde d'évacuation et siphon à commander séparément  
 Ablauf Kit und Siphon müssen separat bestellt werden

**AROCK®**

materiale composito ottenuto da una miscela di carbonati e resine poliesteri con finitura superficiale liscia Arock®. Elevata resistenza alle aggressioni chimiche e batteriche

special material composed of carbonates and polyhedral resins. Smooth surface Arock®

matériau spécial composé de carbonates et de résines polyester. Surface lisse Arock®

Spezialwerkstoff aus Carbonaten und Polyesterhärzen Glatte Oberflächen Arock®



Per calcolare il prezzo totale del piano sommare al prezzo dei primi 50 cm il prezzo dei centimetri restanti

To calculate the total price of the top, add the price of the remaining cm to the price of the first 50 cm

Pour calculer le prix total de le plan, ajouter le prix du cm restant au prix des 50 premiers cm

Um den Gesamtpreis für den Platte zu berechnen, addieren Sie den Preis für die verbleibenden cm zum Preis für die ersten 50 cm

cod.	P	H	< 50 cm			
			vasca incl. nel prezzo basin price incl. prix du lavabo incl. Preis des Becken inkl.		prezzo seconda vasca additional basin price prix du lavabo supplémentaire Preis für das zusätzliche Becken	
PSHI45IN	45	1,2				
PSHI51IN	51,5	1,2				
PSHI4506	45	6				
PSHI5106	51,5	6		al cm lineare per linear cm au cm linéaire pro cm		

**Alzata / Wall top / Plan au mur / Platte an die Wand**

cod.	sp.	H	al cm lineare / per linear cm / au cm linéaire / pro cm
PSH015AL	1,2	5 ÷ 15	
PSH040AL	1,2	16 ÷ 40	

**AROCK®**

Filopiano lavabo integrato  
Integrated plan washbasin  
Vasque en plan intégrée  
Integrierte Waschtischplatte

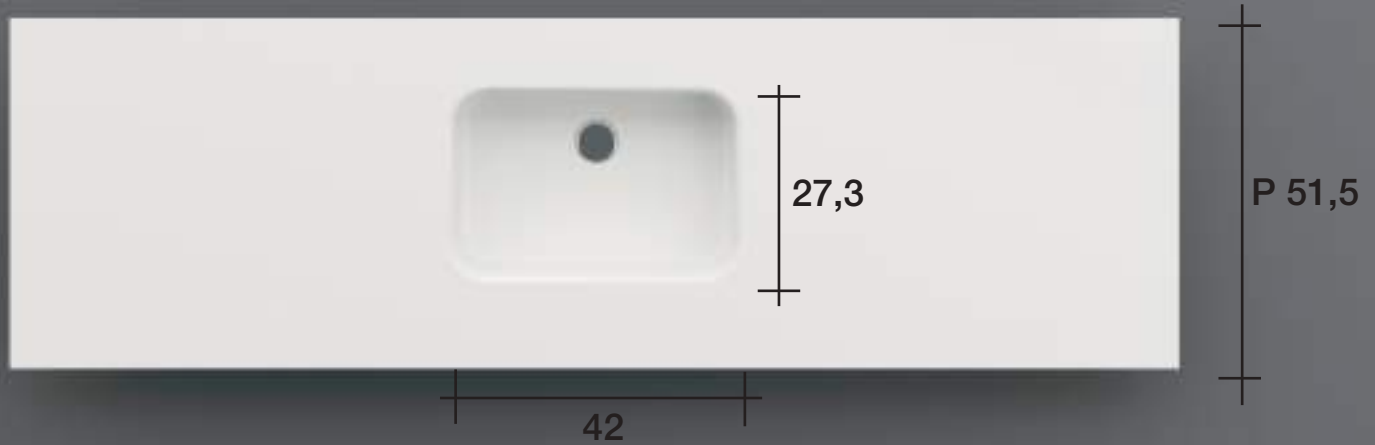
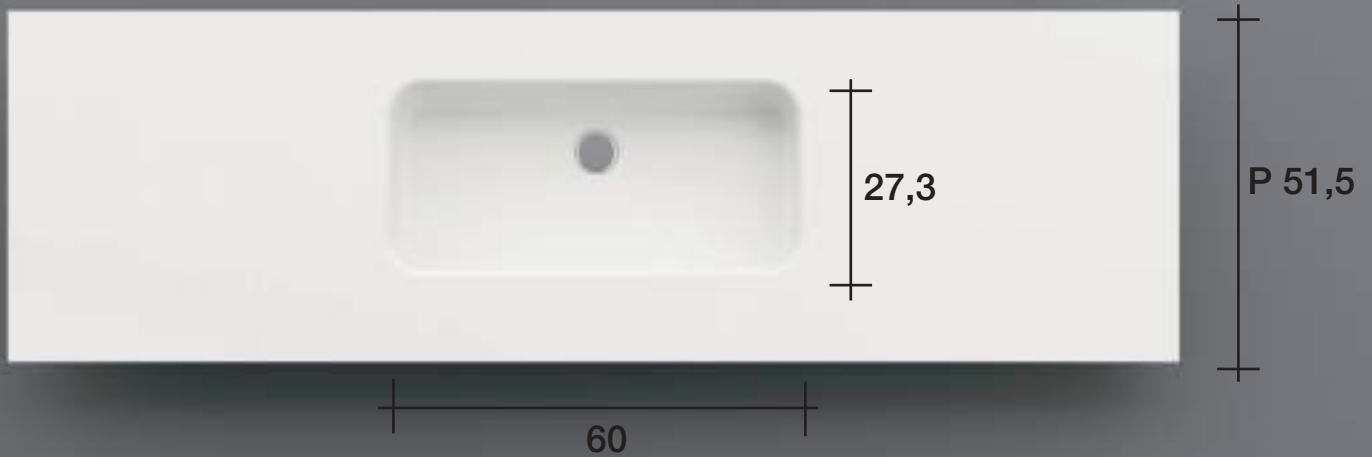

non provvisto di scarico troppopieno  
without overflow system  
sans système de trop-plein  
ohne Überlaufsystem

kit piletta e sifone da ordinare separatamente  
waste kit and siphon to be ordered separately  
kit bonde d'évacuation et siphon à commander séparément  
Ablauf Kit und Siphon müssen separat bestellt werden

**AROCK®**

materiale composito ottenuto da una miscela di carbonati e resine poliesteri con finitura superficiale liscia Arock®. Elevata resistenza alle aggressioni chimiche e batteriche

special material composed of carbonates and polyhedral resins. Smooth surface Arock®

matériau spécial composé de carbonates et de résines polyester. Surface lisse Arock®

Spezialwerkstoff aus Carbonaten und Polyesterhärzen Glatte Oberflächen Arock®



Per calcolare il prezzo totale del piano sommare al prezzo dei primi 50 cm il prezzo dei centimetri restanti

To calculate the total price of the top, add the price of the remaining cm to the price of the first 50 cm

Pour calculer le prix total de le plan, ajouter le prix du cm restant au prix des 50 premiers cm

Um den Gesamtpreis für den Platte zu berechnen, addieren Sie den Preis für die verbleibenden cm zum Preis für die ersten 50 cm

cod.	P	H	< 50 cm			
			vasca incl. nel prezzo basin price incl. prix du lavabo incl. Preis des Becken inkl.		prezzo seconda vasca additional basin price prix du lavabo supplémentaire Preis für das zusätzliche Becken	
PSHV51IN	51,5	1,2				
PSHV5106	51,5	6		al cm lineare per linear cm au cm linéaire pro cm		

**Alzata / Wall top / Plan au mur / Platte an die Wand**

cod.	sp.	H	al cm lineare / per linear cm / au cm linéaire / pro cm
PSH015AL	1,2	5 ÷ 15	<b>3,0 €</b>
PSH040AL	1,2	16 ÷ 40	<b>3,0 €</b>







Filopiano lavabo integrato  
 Integrated plan washbasin  
 Vasque en plan intégrée  
 Integrierte Waschtischplatte



Lavabo filopiano integrato in CRISTALLO extrachiaro verniciato  
 Integrated extra-clear lacquered GLASS basin  
 Vasque intégrée en VERRE lacquée extraclair  
 Platte mit integrierten Becken aus Hochglanz extrahelles GLAS

foro rubinetto incl.  
 tap hole incl.  
 trou pour le robinet incl.  
 Armaturbohrung inkl.

non provvisto di scarico troppopieno  
 without overflow system  
 sans système de trop-plein  
 ohne Überlaufsystem

kit piletta e sifone da ordinare separatamente  
 waste kit and siphon to be ordered separately  
 kit bonde d'évacuation et siphon à commander séparément  
 Ablauf Kit und Siphon müssen separat bestellt werden

**CRISTALLO  
GLASS**

crystallo extrachiario temperato, verniciato. Perimetri molati

extra-clear lacquered glass

verre lacquée extraclair

Hochglanz lackierte Glas

**VERRE  
GLAS**

cod.	P	H				
			vasca incl. nel prezzo basin price incl. prix du lavabo incl. Preis des Becken inkl.	prezzo seconda vasca additional basin price prix du lavabo supplémentaire Preis für das zusätzliche Becken		
PSEI51IN	51,5	1,2	al cm lineare per linear cm au cm linéaire pro cm			

**Alzata / Wall top / Plan au mur / Platte an die Wand**

cod.	sp.	H	al cm lineare / per linear cm / au cm linéaire / pro cm
PSE015AL	1,2	5 ÷ 15	
PSE040AL	1,2	16 ÷ 40	

AROCK®



H 1,2 cm - L max 210 cm



H 6 cm - L max 210 cm

su basi portalavabo min L 54 cm - vasca L 42  
 su basi portalavabo min L 70 cm - vasca L 60

washbasin unit min W 54 cm - integrated basin W 42  
 washbasin unit min W 70 cm - integrated basin W 60

meuble sous-vasque min L 54 cm - vasque L 42  
 meuble sous-vasque min L 70 cm - vasque L 60

Waschtischunterschrank min B 54 cm - Becken B 42  
 Waschtischunterschrank min B 70 cm - Becken B 60

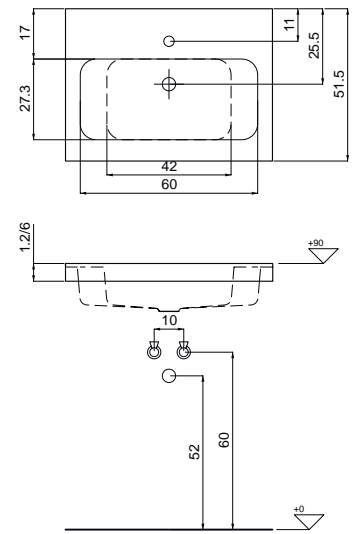
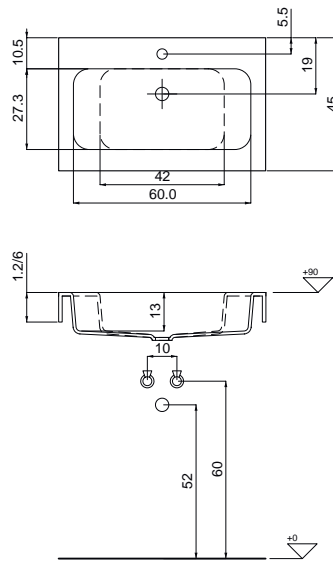

## AROCK®



H 1,2 cm - L max 210 cm



H 6 cm - L max 210 cm

su basi portalavabo min L 54 cm - vasca L 42  
 su basi portalavabo min L 70 cm - vasca L 60

washbasin unit min W 54 cm - integrated basin W 42  
 washbasin unit min W 70 cm - integrated basin W 60

meuble sous-vasque min L 54 cm - vasque L 42  
 meuble sous-vasque min L 70 cm - vasque L 60

Waschtischunterschrank min B 54 cm - Becken B 42  
 Waschtischunterschrank min B 70 cm - Becken B 60

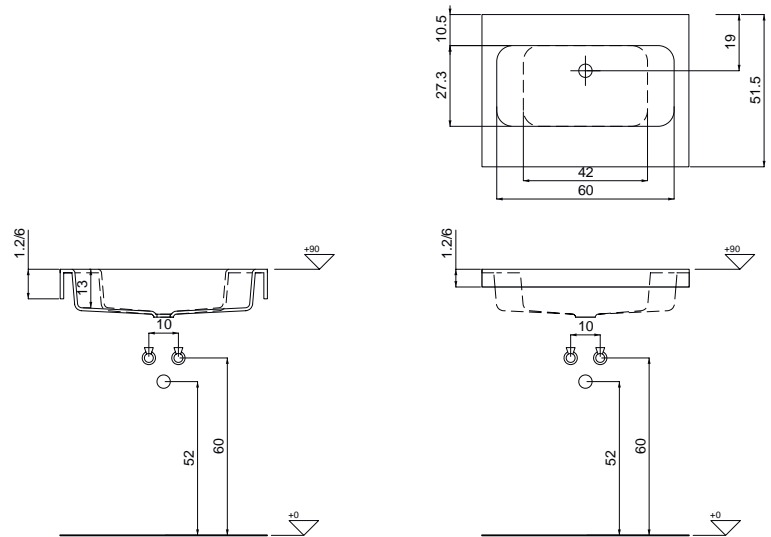
CRISTALLO  
GLASS

su basi portalavabo min L 70 cm  
 washbasin unit min W 70 cm  
 meuble sous-vasque min L 70 cm  
 Waschtischunterschrank min B 70 cm

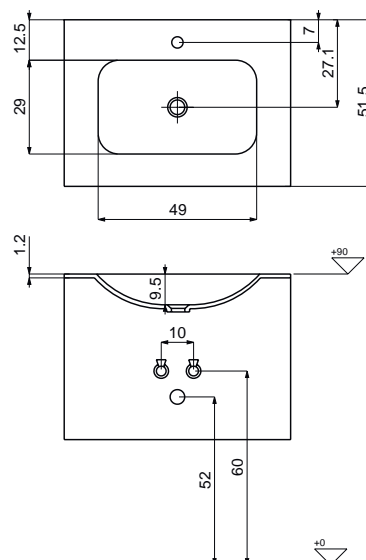
VERRE  
GLAS



PIANI PER MOBILI E PER BASI D'ARREDO



PIANI PER MOBILI

ALCENTIMETRO

PROGETTO

PIANI PER BASI D'ARREDO

**AROCK®**

materiale composito ottenuto da una miscela di carbonati e resine poliesteri con finitura superficiale liscia Arock®. Elevata resistenza alle aggressioni chimiche e batteriche

special material composed of carbonates and polyhedral resins. Smooth surface Arock®

matériau spécial composé de carbonates et de résines polyester. Surface lisse Arock®

Spezialwerkstoff aus Carbonaten und Polyesterhärten Glatte Oberflächen Arock®



Per calcolare il prezzo totale del piano sommare al prezzo dei primi 50 cm il prezzo dei centimetri restanti

To calculate the total price of the top, add the price of the remaining cm to the price of the first 50 cm

Pour calculer le prix total de le plan, ajouter le prix du cm restant au prix des 50 premiers cm

Um den Gesamtpreis für den Platte zu berechnen, addieren Sie den Preis für die verbleibenden cm zum Preis für die ersten 50 cm

cod.	P	H	< 50 cm	al cm lineare per linear cm au cm linéaire pro cm	+ prezzo foro lavabo + washbasin hole price + prix du trou pour vasque + Preis für Waschbeckenloch	
PSHA18PA	18	1,2				
PSHA35PA	34	1,2				
PSHA37PA	37	1,2				
PSHA43PA	43,5	1,2				
PSHA45PA	45	1,2				
PSHA51PA	51,5	1,2				
PSHA4506	45	6				
PSHA5106	51,5	6				
PSHA4510	45	10				
PSHA5110	51,5	10				
PSHA4515	45	15				
PSHA5115	51,5	15				
PSHL45AP	45	1,2				
PSHL51AP	51,5	1,2				
PSHL54AP	54	1,2				

**Alzata / Wall top / Plan au mur / Platte an die Wand**

cod.	sp.	H	al cm lineare / per linear cm / au cm linéaire / pro cm
PSH015AL	1,2	5 ÷ 15	
PSH040AL	1,2	16 ÷ 40	

PIANI PER MOBILI

PIANI PER BASI D'ARREDO

**HPL - HIGH PRESSURE LAMINATE**

laminato stratificato ad alta pressione costituito da fogli di cellulosa impregnati con resine fenoliche

high pressure layered laminate, a perfect and strong imitation of the natural wooden surface

stratifiés décoratifs haute pression. Plaques à base de résines thermodurcissables appelées stratifiés

Hochdruckmehrschichtlaminat mit einer dreidimensionalen Erscheinung

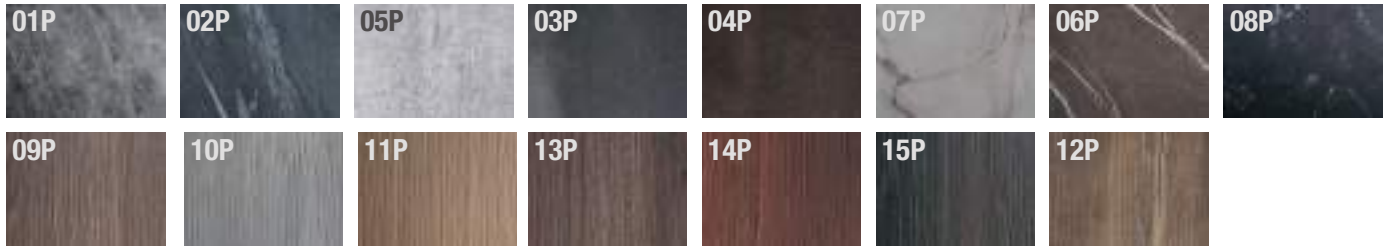

cod.	P	H	al cm lineare per linear cm au cm linéaire pro cm	+ prezzo foro lavabo + washbasin hole price + prix du trou pour vasque + Preis für Waschbeckenloch	
PSDA18PA	18	1			
PSDA35PA	34	1			
PSDA37PA	37	1			
PSDA43PA	43,5	1			
PSDA45PA	45	1			
PSDA51PA	51,5	1			
PSDA54PA	54	1			
PSDA4506	45	6			
PSDA5106	51,5	6			
PSDA4510	45	10			
PSDA5110	51,5	10			
PSDA4515	45	15			
PSDA5115	51,5	15			
PSDL45AP	45	1			
PSDL51AP	51,5	1			
PSDL54AP	54	1			

**Alzata / Wall top / Plan au mur / Platte an die Wand**

cod.	sp.	H	al cm lineare / per linear cm / au cm linéaire / pro cm
PSD015AL	1	5 ÷ 15	
PSD040AL	1	16 ÷ 40	

**Nobilitato LEGNO / ALTATTO**

pannello di particelle di legno spessore 18 mm idrofugo a basso contenuto di formaldeide nobilitato interno ed esterno con carta melaminica in finitura LEGNO riprodotto ad alta fedeltà o ALTATTO; bordo in ABS in finitura

high pressure layered laminate, a perfect and strong imitation of the natural wooden surface

stratifiés decoratifs haute pression. Plaques à base de résines thermodurcissables appelées stratifiés

Hochdruckmehrschichtlaminat mit einer dreidimensionalen Erscheinung

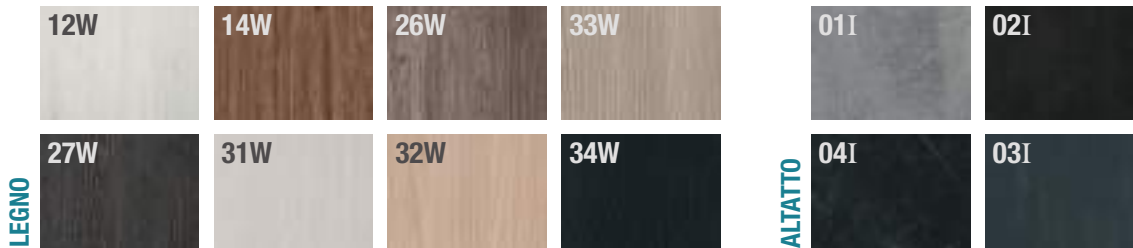

cod.	P	H	al cm lineare per linear cm au cm linéaire pro cm	+ prezzo foro lavabo + washbasin hole price + prix du trou pour vasque + Preis für Waschbeckenloch	
PSFA18PA	18	1,8			
PSFA35PA	34	1,8			
PSFA37PA	37	1			
PSFA43PA	43,5	1			
PSFA45PA	45	1,8			
PSFA51PA	51,5	1,8			
PSFA54PA	54	1,8			
PSFA4506	45	6			
PSFA5106	51,5	6			
PSFA4510	45	10			
PSFA5110	51,5	10			
PSFA4515	45	15			
PSFA5115	51,5	15			
PSFL45AP	45	1,8			
PSFL51AP	51,5	1,8			
PSFL54AP	54	1,8			

**Alzata / Wall top / Plan au mur / Platte an die Wand**

cod.	sp.	H	al cm lineare / per linear cm / au cm linéaire / pro cm
PSF015AL	1,8	5 ÷ 15	
PSF040AL	1,8	16 ÷ 40	

PIANI PER MOBILI

PIANI PER BASI D'ARREDO

**Laccato OPACO / LUCIDO**  
**MATT / GLOSSY Lacquered****Laqué MAT / BRILLANT**  
**MATT / HOCHGLANZ Lackiert**

pannello di particelle di legno, idrofugo, a basso contenuto di formaldeide, verniciato con resine poliuretatiche pigmentate opache o lucide

wood particles panel 18 mm with low formaldehyde content, painted with polyurethane resins

panneaux de particules the bois 18 mm à faible teneur en formaldéhide, peint avec des résines de polyuréthane

Holzpartikelplatte 18 mm mit niedrigem Formaldehydgehalt, mit Polyurethanharzen lackiert



cod.	P	H	prezzo al cm lineare / per linear cm / au cm linéaire / pro cm		+ prezzo foro lavabo + washbasin hole price + prix du trou pour vasque + Preis für Waschbeckenloch	
			F1	F2		
PSFA18PA	18	1,8				
PSFA35PA	34	1,8				
PSFA37PA	37	1,8				
PSFA43PA	43	1,8				
PSFA45PA	45	1,8				
PSFA51PA	51,5	1,8				
PSFA54PA	54	1,8				
PSFA4506	45	6				
PSFA5106	51,5	6				
PSFA4510	45	10				
PSFA5110	51,5	10				
PSFA4515	45	15				
PSFA5115	51,5	15				
PSFL45AP	45	1,8				
PSFL51AP	51,5	1,8				
PSFL54AP	54	1,8				

**Alzata / Wall top / Plan au mur / Platte an die Wand**

cod.	sp.	H	al cm lineare / per linear cm / au cm linéaire / pro cm	
			F1	F2
PSF015AL	1,8	5 ÷ 15		
PSF040AL	1,8	16 ÷ 40		

**PIETRA NATURALE  
NATURAL STONE**





materiale reperibile in natura, resistente e durevole. Superficialmente trattato con apposito impregnante per ridurre l'assorbimento e meglio resistere alle macchie. Le diverse tonalità e disposizioni delle venature sono sinonimo di autenticità

strong and durable natural material. Treated to resist stains and absorption

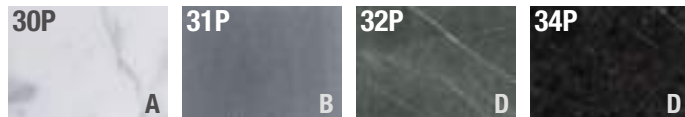
matériau naturel solide et durable. Traité pour résister aux taches et à l'absorption

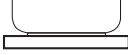
starkes und halbares natürliches Material. Behandelt, um Flecken und Absorption zu widerstehen

**PIERRE NATURELLE  
NATURSTEIN**

cod.	P	H	prezzo al cm lineare / per linear cm / au cm linéaire / pro cm			+ prezzo foro lavabo + washbasin hole price + prix du trou pour vasque + Preis für Waschbeckenloch	
			A	B	D		
PSAA18PA	18	2					
PSAA35PA	34	2					
PSAA37PA	37	2					
PSAA43PA	43	2					
PSAA45PA	45	2					
PSAA51PA	51,5	2					
PSAA54PA	54	2					
PSAL45AP	45	2					
PSAL51AP	51,5	2					
PSAL54AP	54	2					
PSAL51S0	51,5	2					
PSAL54S0	54	2					

**Alzata / Wall top / Plan au mur / Platte an die Wand**

cod.	sp.	H	al cm lineare / per linear cm / au cm linéaire / pro cm		
			A	B	D
PSA015AL	1,2 - 2	5 ÷ 15			
PSA040AL	1,2 - 2	16 ÷ 40			



PIANI PER MOBILI

PIANI PER BASI D'ARREDO

**SILESTONE**





materiale composito costituito per il 94% da quarzo naturale, resine poliestere e pigmenti naturali. Estremamente duro e resistente. Antibatterico ed igienico. Altamente resistente alle macchie. Elevata resistenza a graffi e urti. Totalmente impermeabile ai liquidi

special material composed of quartz and natural pigments. Treated to resist stains and absorption

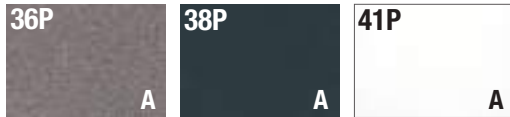
matériaux spécial composé the quartz et pigments naturels. Traité pour résister aux taches et à l'absorbtion

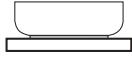
Spezialwerkstoff aus Quarz und natürlichen Pigmente. Behandelt, um Flecken und Absorption zu widerstehen

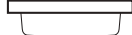

cod.	P	H	prezzo al cm lineare / per linear cm / au cm linéaire / pro cm		+ prezzo foro lavabo + washbasin hole price + prix du trou pour vasque + Preis für Waschbeckenloch	
			A			
PSAA18PA	18	1,2				
PSAA35PA	34	1,2				
PSAA37PA	37	1,2				
PSAA43PA	43	1,2				
PSAA45PA	45	1,2				
PSAA51PA	51,5	1,2				
PSAA54PA	54	1,2				
PSAL45AP	45	1,2				
PSAL51AP	51,5	1,2				
PSAL54AP	54	1,2				
PSAL51S0	51,5	1,2				
PSAL54S0	54	1,2				

**Alzata / Wall top / Plan au mur / Platte an die Wand**

cod.	sp.	H	al cm lineare / per linear cm / au cm linéaire / pro cm	
			A	
PSA015AL	1,2 - 2	5 ÷ 15		
PSA040AL	1,2 - 2	16 ÷ 40		

## GRES





materiale ceramico compatto con superficie estremamente resistente alle macchie, ai graffi e agli urti. Antibatterico e igienico.

compact ceramic material with extremely resistant decorated and enamelled surface.

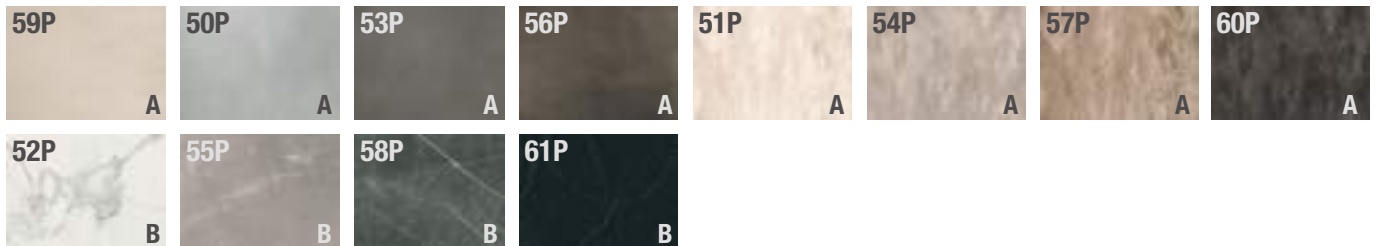
matériau céramique compact avec une surface décorée et émaillée extrêmement résistante.

kompakter Keramikwerkstoff mit extrem widerstandsfähiger dekoriertes und emailierter Oberfläche.



cod.	P	H	prezzo al cm lineare / per linear cm / au cm linéaire / pro cm			+ prezzo foro lavabo + washbasin hole price + prix du trou pour vasque + Preis für Waschbeckenloch	
			A	B			
PSBA18PA	18	0,6					
PSBA35PA	34	0,6					
PSBA37PA	37	0,6					
PSBA43PA	43	0,6					
PSBA45PA	45	0,6					
PSBA51PA	51,5	0,6					
PSBA54PA	54	0,6					
PSCA18PA	18	1,2					
PSCA35PA	35	1,2					
PSBA37PA	37	1,2					
PSBA43PA	43	1,2					
PSCA45PA	45	1,2					
PSCA51PA	51,5	1,2					
PSCA54PA	54	1,2					
PSCL45AP	45	1,2					
PSCL51AP	51,5	1,2					
PSCL54AP	54	1,2					

Alzata / Wall top / Plan au mur / Platte an die Wand

cod.	sp.	H	al cm lineare / per linear cm / au cm linéaire / pro cm	
			A	B
PSB015AL	0,6	5 ÷ 15		
PSB040AL	0,6	16 ÷ 40		

**GRES accoppiato**  
**Coated GRES**

materiale ceramico compatto con superficie estremamente resistente alle macchie, ai graffi e agli urti. Antibatterico e igienico. Accoppiato al piano Laccato OPACO/LUCIDO o Nobilitato LEGNO/ALTATTO

compact ceramic material with extremely resistant decorated and enamelled surface. Coated to the top Laccato MATT/GLOSSY or Nobilitato LEGNO/ALTATTO

matériau céramique compact avec une surface décorée et émaillée extrêmement résistante. Couplé avec le plan Laccato MAT/BRILLANT ou Nobilitato LEGNO/ALTATTO

kompakter Keramikwerkstoff mit extrem widerstandsfähiger dekoriertes und emailierter Oberfläche. Verdoppelte mit Oberflächen Laccato MATT/HOCHGLANZ oder Nobilitato LEGNO/ALTATTO

**GRES accouplé**  
**Verdoppelte GRES**

il piano in GRES H 0,6 cm va accoppiato al piano Nobilitato LEGNO, Nobilitato ALTATTO e Laccato OPACO/LUCIDO  
GRES H 0,6 cm must be coupled with tops Nobilitato LEGNO, Nobilitato ALTATTO and MATT/GLOSSY Lacquered  
GRES H0,6 cm doit être couplé avec un plan en Nobilitato LEGNO, Nobilitato ALTATTO et MAT/BRILLANT Laqué  
GRES H 0,6 cm muss mit Platte verdoppelt werden

cod.	P	H	prezzo al cm lineare / per linear cm / au cm linéaire / pro cm			+ prezzo foro lavabo + washbasin hole price + prix du trou pour vasque + Preis für Waschbeckenloch	
			A	B			
PSGA4506	45	6,6					
PSGA5106	51,5	6,6					
PSGA4510	45	10,6					
PSGA5110	51,5	10,6					
PSGA4515	45	15,6					
PSGA5115	51,5	15,6					
PSGL45AP	45	2,4					
PSGL51AP	51,5	2,4					
PSGL54AP	54	2,4					



SPECCHI LINEO E AERO ALCENTIMETRO







. profilo tecnico estruso in alluminio  
 . reversibile  
 . min L 20 x 20 / max L 120 X 200 cm

. profilé technique en aluminium extrudé  
 . réversible  
 . min L 20 x 20 / max L 120 X 200 cm

. extruded aluminum technical profile  
 . reversible  
 . min L 20 x 20 / max L 120 X 200 cm

. technisches Aluminiumprofil  
 . umkehrbar  
 . min L 20 x 20 / max L 120 X 200 cm

Tbrill®

C24

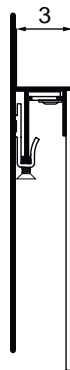
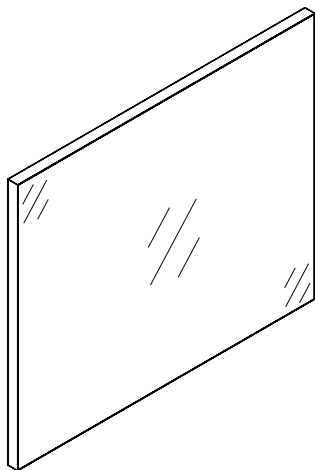
**LINEO**

cod. N5S000L0

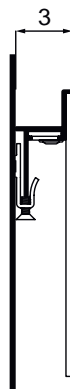
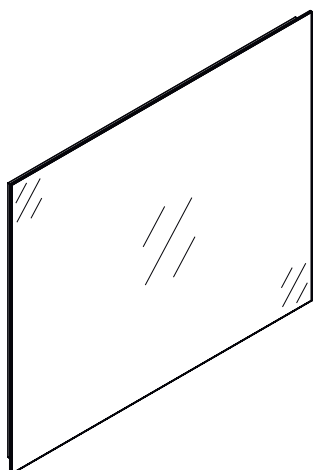
**AERO**

cod. N5S000A0

# Specchi Mirrors

# Miroirs Spiegel

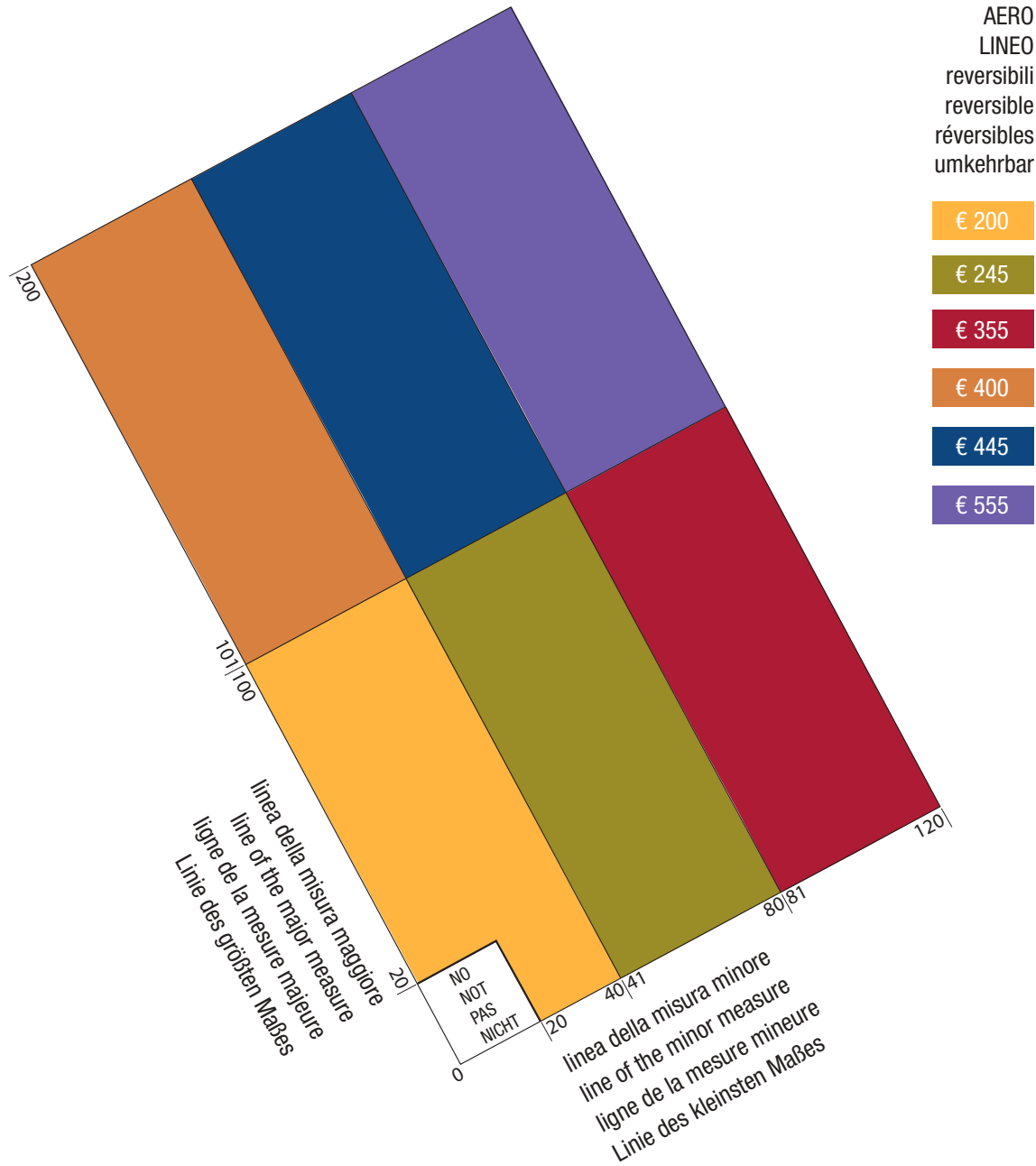
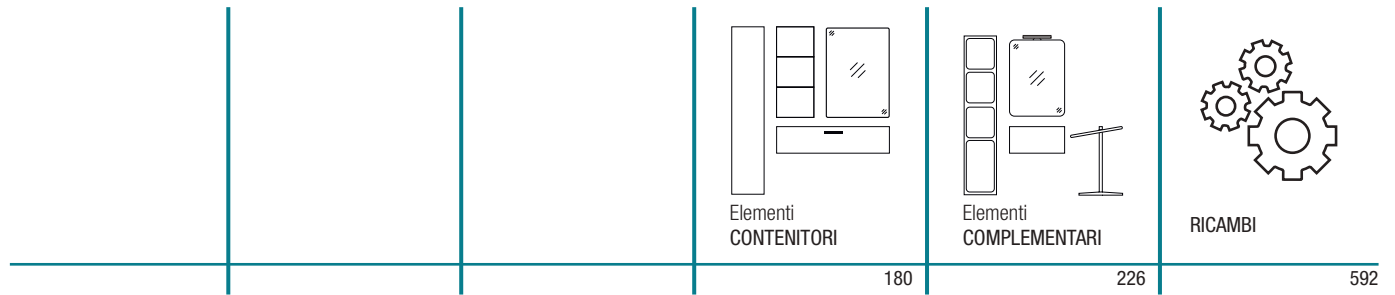

AERO  
LINEO  
reversibili  
reversible  
réversibles  
umkehrbar

€ 200

€ 245

€ 355

€ 400

€ 445

€ 555

## NON SERVE

parlare di altezza e larghezza,  
ogni lato permette il fissaggio a muro

## NOT NEEDED

talk about height and width,  
each side allows wall mounting

## INUTILE

parler de hauteur et de largeur,  
chaque côté permet un montage mural

## NICHT NÖTIG

über Höhe und Breite sprechen,  
jede Seite ermöglicht eine Wandmontage

## SERVE

.avere le misure: minore / maggiore  
.trovare l'area colore del loro incrocio  
.leggere il prezzo nell'area colore

## NEEDED

.have the minor/major measures  
.find the color area of their intersection  
.read the price in the color area

## REQUIS

.avoir les mineur/majeur mesures  
.trouver la zone de couleur de leur  
intersection  
.lire le prix dans la zone de couleur

## NÖTIG

.die kleinen/großen Maßnahmen haben  
.den Farbbereich ihrer Kreuzung finden  
.der Preis im Farbbereich lesen

MENSOLA NOBILITATO / LACCATO ALCENTIMETRO





. mensola realizzata con pannello di particelle di legno spessore 1,8 cm nelle finiture Nobilitato LEGNO / ALTATTO e Laccato OPACO / LUCIDO  
 . fori di fissaggio predisposti  
 . L min 30 / L max 140 cm

. wood shelf, 1.8 cm thick, finished in Nobilitato LEGNO / ALTATTO or MATT / GLOSSY lacquered  
 . fixing holes already prepared  
 . L min 30 / L max 140 cm

. étagère en bois, 1,8 cm d'épaisseur, fini en Nobilitato LEGNO / ALTATTO ou MAT / BRILLANT laqué  
 . trous de fixation déjà préparés  
 . L min 30 / L max 140 cm

. Holzregal, 1,8 cm dicke, Ausführung in Nobilitato LEGNO / ALTATTO oder MATT / HOCH GLANZ lackiert  
 . Befestigungslöcher vorbereitet  
 . L min 30 / L max 140 cm

### Nobilitato LEGNO



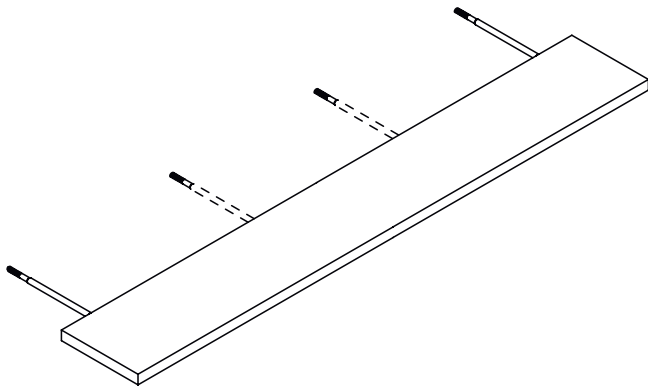
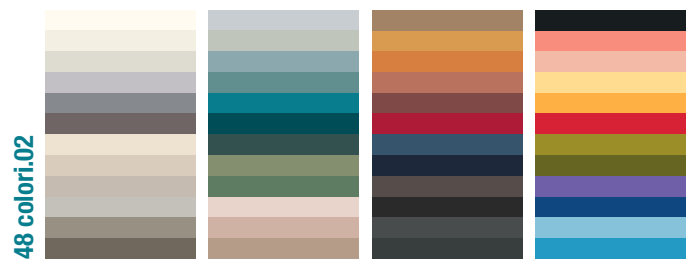

### laccato OPACO / LUCIDO MATT / GLOSSY lacquered laqué MAT / BRILLANT MATT / HOCHGLANZ lackiert

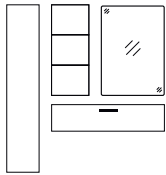
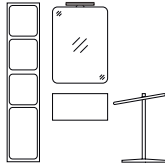

# Mensola Shelf

# Étagère Regalelement

			 <p>Elementi CONTENITORI</p>	 <p>Elementi COMPLEMENTARI</p>	 <p>RICAMBI</p>
			180	226	592

**H 1,8**

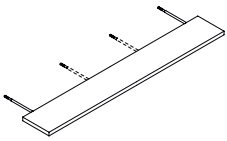

**P 15**

Mensola in Nobilitato e laccato  
Nobilitato & laquered shelf  
Étagère en Nobilitato & laqué  
Regalelement aus Nobilitato & Lackiert

**L**

min 30-max 140 N5M00015

**F1**

**F2**

**F3**

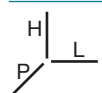
  
 H |  
 P / L  
 Misure in cm  
 Measures in cm  
 Mesures en cm  
 Maße in cm

**F1** Laccato opaco  
Matt lacquered  
Laqué mat  
Matt lackiert

**F2** Laccato lucido  
Glossy lacquered  
Laqué brillant  
Hochglanz lackiert

**F3** Nobilitati  
Veneer wood  
Placage bois  
Beschichtetes Holz

**F4** Arock®  
Arock®  
Arock®  
Arock®

**F5** abitat / vogue  
abitat / vogue  
abitat / vogue  
abitat / vogue







. panca realizzata con pannello di particelle di legno spessore 3,6 cm nelle finiture Nobilitato LEGNO e Laccato OPACO / LUCIDO  
 . la direzione della vena è orizzontale sul piano e verticale sulle gambe  
 . il numero delle gambe varia in base alla lunghezza  
 . L min 60 / L max 220 cm

. bench, 3,6 cm thick, finished in Nobilitato LEGNO or MATT / GLOSSY lacquered  
 . the number of legs is according to the length of the bench  
 . L min 60 / L max 220 cm

. banquette en bois, 3,6 cm d'épaisseur, fini en Nobilitato LEGNO ou MAT / BRILLANT laqué  
 . le nombre de pieds est en fonction de la longueur de la banquette  
 . L min 60 / L max 220 cm

. Bank, 3,6 cm dicke, Ausführung in Nobilitato LEGNO oder MATT / HOCHGLANZ lackiert  
 . die Anzahl der Beine richtet sich nach der Länge der Bank  
 . L min 60 / L max 220 cm

### Nobilitato LEGNO



### laccato OPACO / LUCIDO MATT / GLOSSY lacquered laqué MAT / BRILLANT MATT / HOCHGLANZ lackiert

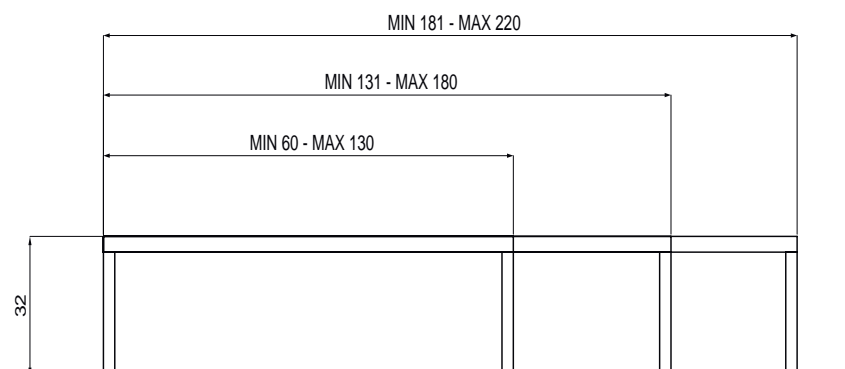
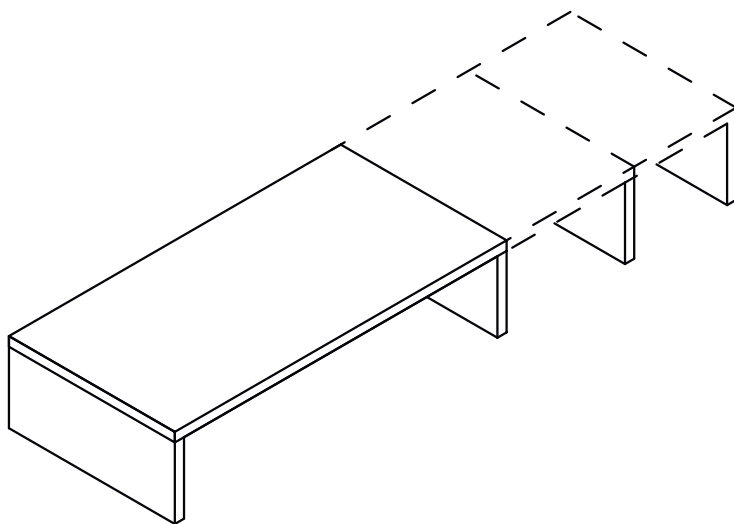
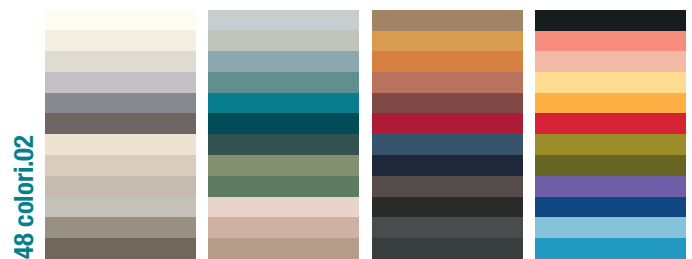

# Panca Bench

# Banquette Bank

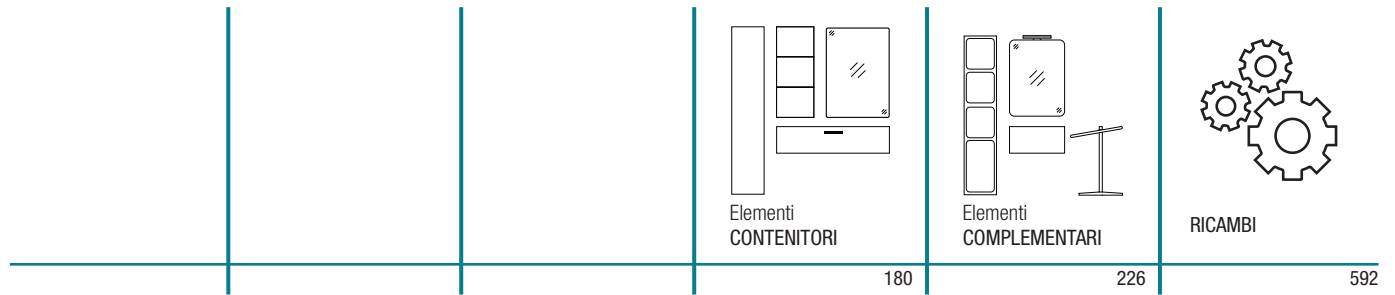
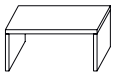
**H 32****P 50**

Panca  
Bench  
Banquette  
Bank

**L** 60÷130 LAK13002 **F1** **F2** **F3**

**P 65**

**L** 60÷130 LAK13012 **F1** **F2** **F3**

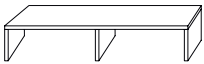
**H 32****P 50**

Panca  
Bench  
Banquette  
Bank

**L** 131÷180 LAK18002 **F1** **F2** **F3**

**P 65**

**L** 131÷180 LAK18012 **F1** **F2** **F3**

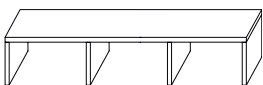
**H 32****P 50**

Panca  
Bench  
Banquette  
Bank

**L** 181÷220 LAK22002 **F1** **F2** **F3**

**P 65**

**L** 181÷220 LAK22012 **F1** **F2** **F3**

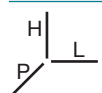

Misure in cm  
Measures in cm  
Mesures en cm  
Maße in cm

**F1** Laccato opaco  
Matt lacquered  
Laqué mat  
Matt lackiert

**F2** Laccato lucido  
Glossy lacquered  
Laqué brillant  
Hochglanz lackiert

**F3** Nobilitati  
Veneer wood  
Placage bois  
Beschichtetes Holz

**F4** Arock®  
Arock®  
Arock®  
Arock®

**F5** abitat / vogue  
abitat / vogue  
abitat / vogue  
abitat / vogue







- . bancone realizzato con pannello di particelle di legno spessore 3,6 cm nelle finiture Nobilitato LEGNO e Laccato OPACO / LUCIDO
- . la direzione della vena è orizzontale sul piano e verticale sulle gambe
- . il numero delle gambe varia in base alla lunghezza
- . L min 60 / L max 220 cm

- . work-bench, 3,6 cm thick, finished in Nobilitato LEGNO or MATT / GLOSSY lacquered
- . the number of legs is according to the length of the work-bench
- . L min 60 / L max 220 cm

- . banc de travail en bois, 3,6 cm d'épaisseur, fini en Nobilitato LEGNO ou MAT / BRILLANT laqué
- . le nombre de pieds est en fonction de la longueur du banc de travail
- . L min 60 / L max 220 cm

- . Arbeitsbank, 3,6 cm dicke, Ausführung in Nobilitato LEGNO oder MATT / HOCHGLANZ lackiert
- . die Anzahl der Beine richtet sich nach der Länge der Arbeitsbank
- . L min 60 / L max 220 cm

## Nobilitato LEGNO

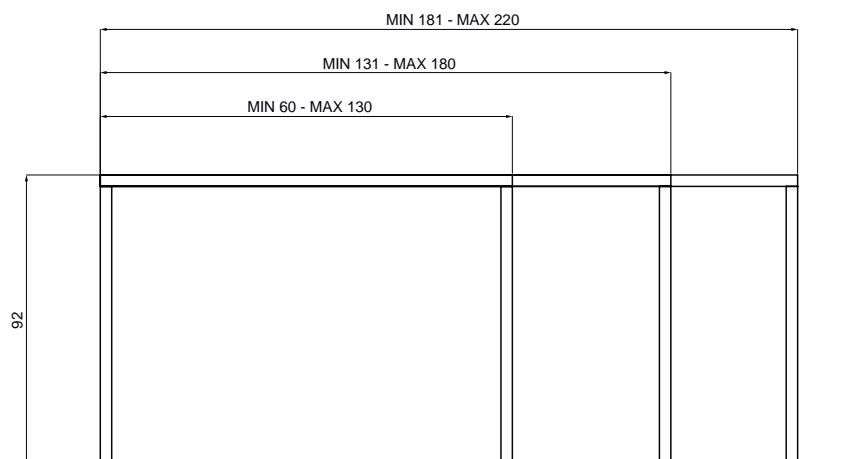
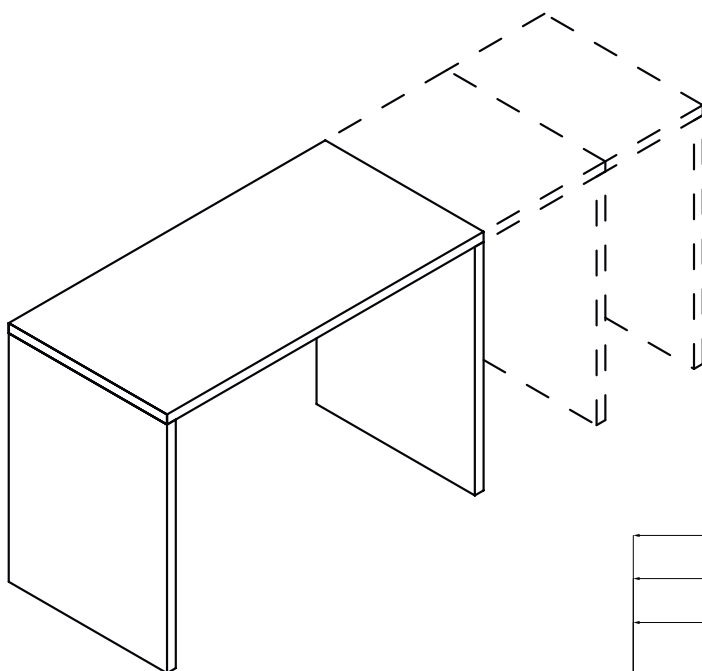
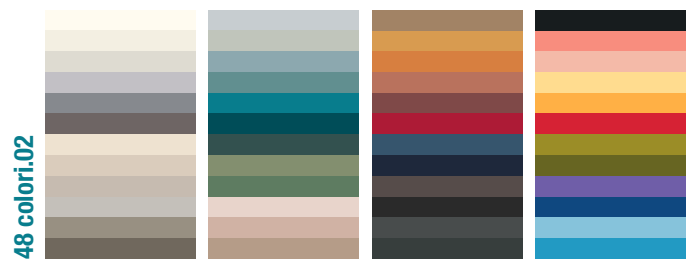
 laccato OPACO / LUCIDO  
 MATT / GLOSSY lacquered  
 laqué MAT / BRILLANT  
 MATT / HOCHGLANZ lackiert



## Bancone Work bench

## Banc de travail Arbeitsplat

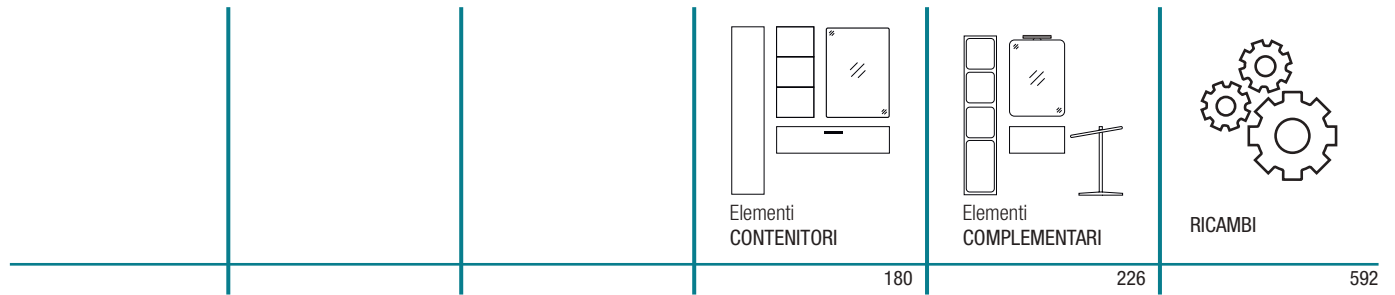
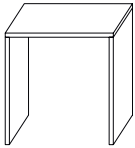
**H 92**

Bancone • a richiesta foro lavabo € 60  
 Work bench • tap hole on demand € 60  
 Banc de travail • sur demande le découpe pour vasque € 60  
 Arbeitsplat • Abschnitt für Waschbecken auf Anfrage € 60

**P 65**

<b>L</b>	<b>F1</b>	<b>F2</b>	<b>F3</b>
60÷130	LAK13020		

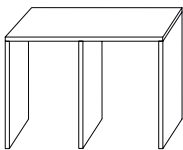
**H 92**

Bancone • a richiesta foro lavabo € 60  
 Work bench • tap hole on demand € 60  
 Banc de travail • sur demande le découpe pour vasque € 60  
 Arbeitsplat • Abschnitt für Waschbecken auf Anfrage € 60

**P 65**

<b>L</b>	<b>F1</b>	<b>F2</b>	<b>F3</b>
131÷180	LAK18022		

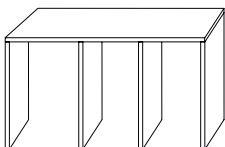
**H 92**

Bancone • a richiesta foro lavabo € 60  
 Work bench • hole for basin on demand € 60  
 Banc de travail • sur demande le découpe pour vasque € 60  
 Arbeitsplat • Abschnitt für Waschbecken auf Anfrage € 60

**P 65**

<b>L</b>	<b>F1</b>	<b>F2</b>	<b>F3</b>
181÷220	LAK22024		

Misure in cm  
 Measures in cm  
 Mesures en cm  
 Maße in cm

**F1** Laccato opaco  
 Matt lacquered  
 Laqué mat  
 Matt lackiert

**F2** Laccato lucido  
 Glossy lacquered  
 Laqué brillant  
 Hochglanz lackiert

**F3** Nobilitati  
 Veneer wood  
 Placage bois  
 Beschichtetes Holz

**F4** Arock®  
 Arock®  
 Arock®  
 Arock®

**F5** abitat / vogue  
 abitat / vogue  
 abitat / vogue  
 abitat / vogue

ZOCCOLO D'ARREDO ALCENTIMETRO





. zoccolo H 3 cm in estruso di alluminio finitura satinata

. socle de 3 cm de hauteur en aluminium finition satinée

. 3 cm high toe-kick in aluminum satinated finishing

. 3 cm H Sockel in Satin-Aluminium Ausführung

### alluminio satinato

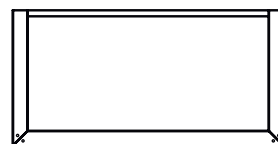
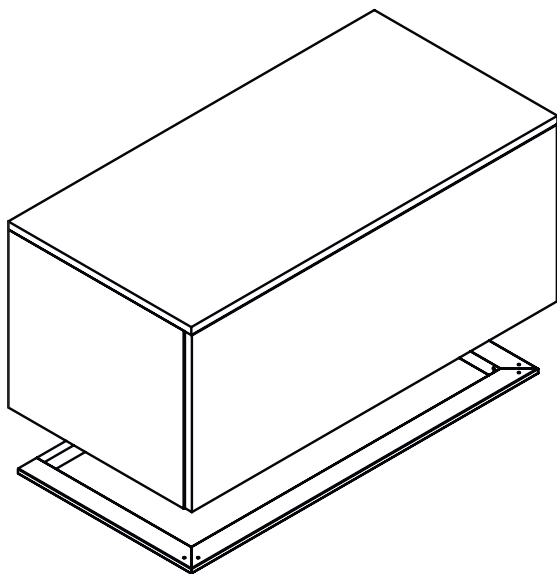
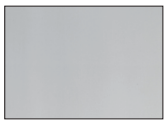

→ (L - 5) cm

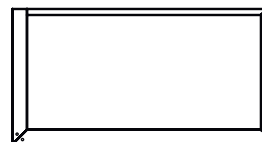

→ (L - 2,5) cm

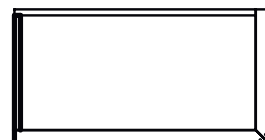

→ (L - 2,5) cm

## Zoccolo Toe-kick

## Socle Sockel

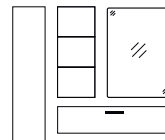
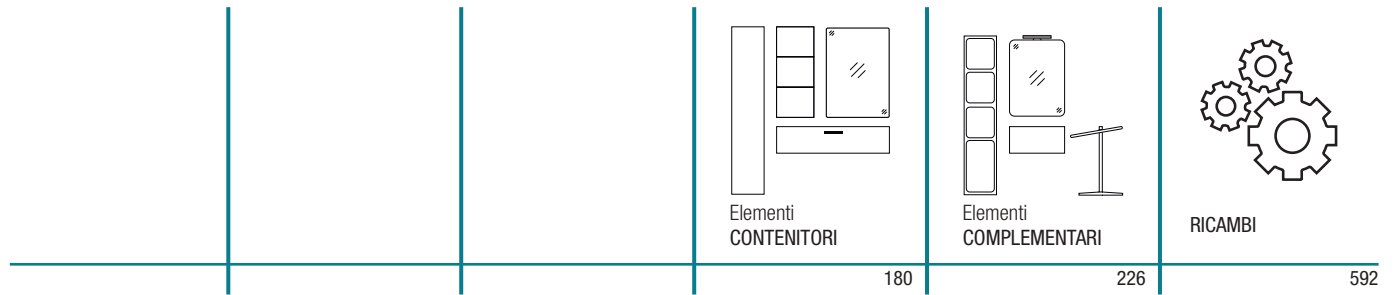

Elementi  
CONTENITORI

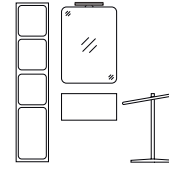

Elementi  
COMPLEMENTARI



RICAMBI

180

226

592

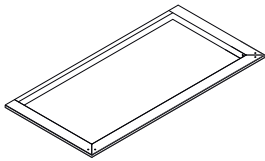
**H 3****P 42,5**

zoccolo 3 lati  
3 sides toe-kick  
3 cotés socle  
3 seite Sockel

**L**

min 25-max 210

OMZAL401

**P 49****L**

min 25-max 210

OMZAL501

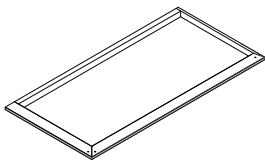
**H 3****P 42,5**

zoccolo Sx  
toe-kick  
socle  
Sockel

**L**

min 25-max 210

OMZAL402

**P 49****L**

min 25-max 210

OMZAL502

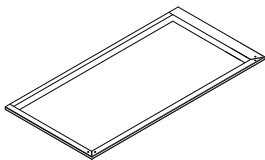
**H 3****P 42,5**

zoccolo Dx  
toe-kick  
socle  
Sockel

**L**

min 25-max 210

OMZAL403

**P 49****L**

min 25-max 210

OMZAL503

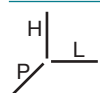

Misure in cm  
Measures in cm  
Mesures en cm  
Maße in cm

**F1** Laccato opaco  
Matt lacquered  
Laqué mat  
Matt lackiert

**F2** Laccato lucido  
Glossy lacquered  
Laqué brillant  
Hochglanz lackiert

**F3** Nobilitati  
Veneer wood  
Placage bois  
Beschichtetes Holz

**F4** Arock®  
Arock®  
Arock®  
Arock®

**F5** abitat / vogue  
abitat / vogue  
abitat / vogue  
abitat / vogue





**ELEMENTI**

PER CREARE E COMPLETARE UN ARREDAMENTO

**CONTENITORI**tutte le **BASI D'ARREDO**tutti i **PENSILI CON ANTA SPECCHIATA**tutti i **PENSILI**tutti i **PENSILI A GIORNO**

SOLO VERTICALI

tutte le **COLONNE**tutte le **COLONNE A GIORNO**

SOLO VERTICALI



BASI D'ARREDO APERTURE LEALE



# Basi Units

# Meubles bas Unterschränke

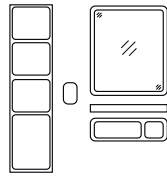

UNICAMENTE  
AROCK®

34

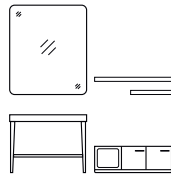

ALCENTIMETRO  
PROGETTO

98

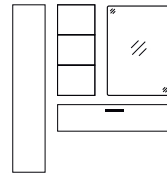

Elementi  
CONTENITORI

180

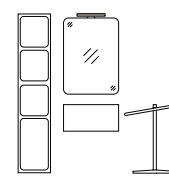

Elementi  
COMPLEMENTARI

226



RICAMBI

592

## H 25

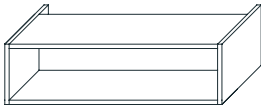

## P 45

Base a giorno  
Side shelving unit  
Meuble bas ouvert  
Unterschrank Regalelement

L		F1	F2	F3
30	N5Q03024			
35	N5Q03524			
45	N5Q04524			
50	N5Q05024			
60	N5Q06024			
70	N5Q07024			
90	N5Q09024			
105	N5Q10524			
120	N5Q12024			

## P 51,5

L		F1	F2	F3
30	N5Q03016			
35	N5Q03516			
45	N5Q04516			
50	N5Q05016			
60	N5Q06016			
70	N5Q07016			
90	N5Q09016			
105	N5Q10516			
120	N5Q12016			

## H 40

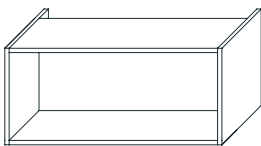

## P 45

Base a giorno  
Side shelving unit  
Meuble bas ouvert  
Unterschrank Regalelement

L		F1	F2	F3
30	N5Q03025			
35	N5Q03525			
45	N5Q04525			
50	N5Q05025			
60	N5Q06025			
70	N5Q07025			
90	N5Q09025			
105	N5Q10525			
120	N5Q12025			

## P 51,5

L		F1	F2	F3
30	N5Q03034			
35	N5Q03534			
45	N5Q04534			
50	N5Q05034			
60	N5Q06034			
70	N5Q07034			
90	N5Q09034			
105	N5Q10534			
120	N5Q12034			

## H 50

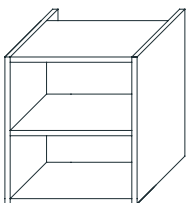

## P 45

Base a giorno • 2 vani  
Side shelving unit • 2 compartments  
Meuble bas ouvert • 2 compartiments  
Unterschrank Regalelement • 2 Fächer

L		F1	F2	F3
30	N5Q03026			
35	N5Q03526			
45	N5Q04526			
50	N5Q05026			
60	N5Q06026			
70	N5Q07026			

## P 51,5

L		F1	F2	F3
30	N5Q03027			
35	N5Q03527			
45	N5Q04527			
50	N5Q05027			
60	N5Q06027			
70	N5Q07027			

H  
L  
P

Misure in cm  
Mesures in cm  
Mesures en cm  
Maße in cm

**F1** Laccato opaco  
Matt lacquered  
Laqué mat  
Matt lackiert

**F2** Laccato lucido  
Glossy lacquered  
Laqué brillant  
Hochglanz lackiert

**F3** Nobilitati  
Veneer wood  
Placage bois  
Beschichtetes Holz

**F4** Arock®  
Arock®  
Arock®  
Arock®

**F5** abitat / vogue  
abitat / vogue  
abitat / vogue  
abitat / vogue

# Basi Units

# Meubles bas Unterschränke

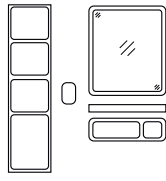

UNICAMENTE  
AROCK®

34

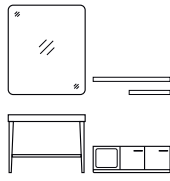

ALCENTIMETRO  
PROGETTO

98

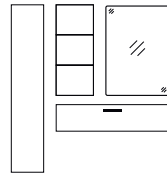

Elementi  
CONTENITORI

180

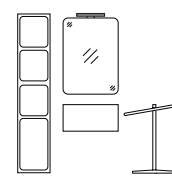

Elementi  
COMPLEMENTARI

226



RICAMBI

592

## H 25

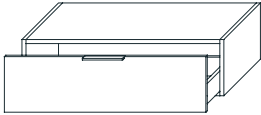

## P 45

Maniglia FILO & chiusura ammortizzata • base laterale • 1 cassetto  
FILO Handle & soft-closing • side unit • 1 pull-out  
Poignée FILO & fermeture amortie • meuble bas latéral • 1 tiroir  
FILO Griff • Seitenschrank • 1 Soft-Closing Schublade

L		F1	F2	F3
30	N2B03001			
35	N2B03501			
45	N2B04501			
50	N2B05001			
60	N2B06001			
70	N2B07001			
90	N2B09001			
105	N2B10501			
120	N2B12001			

## P 51,5

L		F1	F2	F3
30	N2B03051			
35	N2B03551			
45	N2B04551			
50	N2B05051			
60	N2B06051			
70	N2B07051			
90	N2B09051			
105	N2B10551			
120	N2B12051			

## H 40

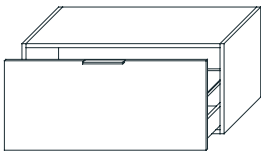

## P 45

Maniglia FILO & chiusura ammortizzata • base laterale • 1 cassetto  
FILO Handle & soft-closing • side unit • 1 pull-out  
Poignée FILO & fermeture amortie • meuble bas latéral • 1 tiroir  
FILO Griff • Seitenschrank • 1 Soft-Closing Schublade

L		F1	F2	F3
30	N2B03007			
35	N2B03507			
45	N2B04507			
50	N2B05007			
60	N2B06007			
70	N2B07007			
90	N2B09007			
105	N2B10507			
120	N2B12007			

## P 51,5

L		F1	F2	F3
30	N2B03057			
35	N2B03557			
45	N2B04557			
50	N2B05057			
60	N2B06057			
70	N2B07057			
90	N2B09057			
105	N2B10557			
120	N2B12057			

## H 40

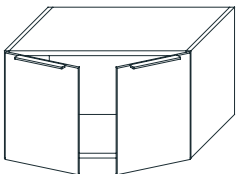

## P 45

Maniglia FILO & chiusura ammortizzata • base laterale • 2 ante  
FILO Handle & soft-closing • side unit • 2 doors  
Poignée FILO & fermeture amortie • meuble bas latéral • 2 portes  
FILO Griff • Seitenschrank • 2 Türen

L		F1	F2	F3
50	N2B05010			
60	N2B06010			
70	N2B07010			
90	N2B09010			

## P 51,5

L		F1	F2	F3
50	N2B05060			
60	N2B06060			
70	N2B07060			
90	N2B09060			



Misure in cm  
Measures in cm  
Mesures en cm  
Maße in cm

**F1** Laccato opaco  
Matt lacquered  
Laqué mat  
Matt lackiert

**F2** Laccato lucido  
Glossy lacquered  
Laqué brillant  
Hochglanz lackiert

**F3** Nobilitati  
Veneer wood  
Placage bois  
Beschichtetes Holz

**F4** Arock®  
Arock®  
Arock®  
Arock®

**F5** abitat / vogue  
abitat / vogue  
abitat / vogue  
abitat / vogue

## Basi Units

## Meubles bas Unterschränke

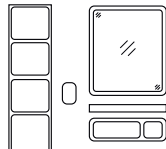

UNICAMENTE  
AROCK®

34

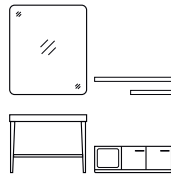

ALCENTIMETRO  
PROGETTO

98

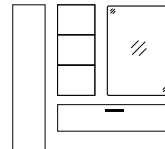

Elementi  
CONTENITORI

180

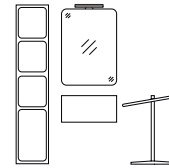

Elementi  
COMPLEMENTARI

226



RICAMBI

592

### H 40

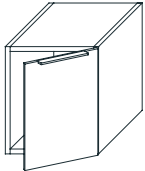

### P 45

Maniglia FILO & chiusura ammortizzata • base laterale dx • 1 anta  
FILO Handle & soft-closing • side unit • 1 door  
Poignée FILO & fermeture amortie • meuble bas latéral • 1 porte  
FILO Griff • Seitenschrank • 1 Tür

L		F1	F2	F3
30	N2B03008			
35	N2B03508			
45	N2B04508			

### P 51,5

L		F1	F2	F3
30	N2B03058			
35	N2B03558			
45	N2B04558			

### H 40

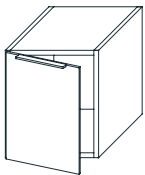

### P 45

Maniglia FILO & chiusura ammortizzata • base laterale sx • 1 anta  
FILO Handle & soft-closing • side unit • 1 door  
Poignée FILO & fermeture amortie • meuble bas latéral • 1 porte  
FILO Griff • Seitenschrank • 1 Tür

L		F1	F2	F3
30	N2B03009			
35	N2B03509			
45	N2B04509			

### P 51,5

L		F1	F2	F3
30	N2B03059			
35	N2B03559			
45	N2B04559			

### H50

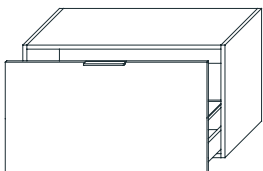

### P 45

Maniglia FILO & chiusura ammortizzata • base laterale • 1 cassetto + 1 ripiano  
FILO Handle & soft-closing • side unit • 1 pull-out + 1 shelf  
Poignée FILO & fermeture amortie • meuble bas latéral • 1 porte + 1 étagère  
FILO Griff • Seitenschrank • 1 Soft-Closing Schublade + 1 Regal

L		F1	F2	F3
30	N2B03019			
35	N2B03519			
45	N2B04519			
50	N2B05019			
60	N2B06019			
70	N2B07019			
90	N2B09019			
105	N2B10519			
120	N2B12019			

### P 51,5

L		F1	F2	F3
30	N2B03069			
35	N2B03569			
45	N2B04569			
50	N2B05069			
60	N2B06069			
70	N2B07069			
90	N2B09069			
105	N2B10569			
120	N2B12069			

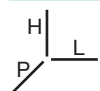

Misure in cm  
Measures in cm  
Mesures en cm  
Maße in cm

**F1** Laccato opaco  
Matt lacquered  
Laqué mat  
Matt lackiert

**F2** Laccato lucido  
Glossy lacquered  
Laqué brillant  
Hochglanz lackiert

**F3** Nobilitati  
Veneer wood  
Placage bois  
Beschichtetes Holz

**F4** Arock®  
Arock®  
Arock®  
Arock®

**F5** abitat / vogue  
abibat / vogue  
abibat / vogue  
abibat / vogue

# Basi Units

# Meubles bas Unterschränke

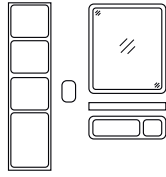

UNICAMENTE  
AROCK®

34

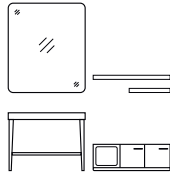

ALCENTIMETRO  
PROGETTO

98

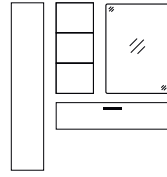

Elementi  
CONTENITORI

180

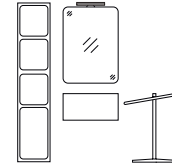

Elementi  
COMPLEMENTARI

226



RICAMBI

592

## H 50

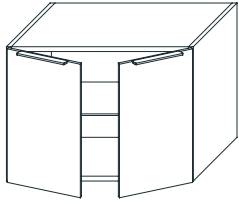

## P 45

Maniglia FILO & chiusura ammortizzata • base laterale • 2 ante + 1 ripiano  
FILO Handle & soft-closing • side unit • 2 doors + 1 shelf  
Poignée FILO & fermeture amortie • meuble bas latéral • 2 portes + 1 étagère  
FILO Griff • Seitenschrank • 2 Türen + 1 Regal

L		F1	F2	F3
50	N2B05014			
60	N2B06014			
70	N2B07014			
90	N2B09014			

## P 51,5

L		F1	F2	F3
50	N2B05064			
60	N2B06064			
70	N2B07064			
90	N2B09064			

## H 50

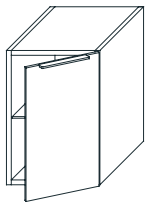

## P 45

Maniglia FILO & chiusura ammortizzata • base laterale dx • 1 anta + 1 ripiano  
FILO Handle & soft-closing • side unit • 1 door + 1 shelf  
Poignée FILO & fermeture amortie • meuble bas latéral • 1 porte + 1 étagère  
FILO Griff • Seitenschrank • 1 Tür + 1 Regal

L		F1	F2	F3
30	N2B03016			
35	N2B03516			
45	N2B04516			

## P 51,5

L		F1	F2	F3
30	N2B03066			
35	N2B03566			
45	N2B04566			

## H 50

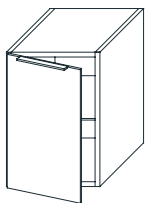

## P 45

Maniglia FILO & chiusura ammortizzata • base laterale sx • 1 anta + 1 ripiano  
FILO Handle & soft-closing • side unit • 1 door + 1 shelf  
Poignée FILO & fermeture amortie • meuble bas latéral • 1 porte + 1 étagère  
FILO Griff • Seitenschrank • 1 Tür + 1 Regal

L		F1	F2	F3
30	N2B03017			
35	N2B03517			
45	N2B04517			

## P 51,5

L		F1	F2	F3
30	N2B03067			
35	N2B03567			
45	N2B04567			



Misure in cm  
Measures in cm  
Mesures en cm  
Maße in cm

**F1** Laccato opaco  
Matt lacquered  
Laqué mat  
Matt lackiert

**F2** Laccato lucido  
Glossy lacquered  
Laqué brillant  
Hochglanz lackiert

**F3** Nobilitati  
Veneer wood  
Placage bois  
Beschichtetes Holz

**F4** Arock®  
Arock®  
Arock®  
Arock®

**F5** abitat / vogue  
abitat / vogue  
abitat / vogue  
abitat / vogue

# Basi Units

# Meubles bas Unterschränke

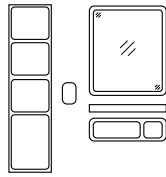

UNICAMENTE  
AROCK®

34

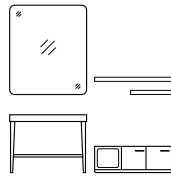

ALCENTIMETRO  
PROGETTO

98

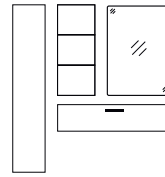

Elementi  
CONTENITORI

180

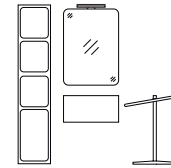

Elementi  
COMPLEMENTARI

226



RICAMBI

592

## H 25



## P 45

Maniglia PONTE & chiusura ammortizzata • base laterale • 1 cassetto  
PONTE Handle & soft-closing • side unit • 1 pull-out  
Poignée PONTE & fermeture amortie • meuble bas latéral • 1 tiroir  
PONTE Griff • Seitenschrank • 1 Soft-Closing Schublade

L		F1	F2	F3
30	N4B03001			
35	N4B03501			
45	N4B04501			
50	N4B05001			
60	N4B06001			
70	N4B07001			
90	N4B09001			
105	N4B10501			
120	N4B12001			

## P 51,5

L		F1	F2	F3
30	N4B03051			
35	N4B03551			
45	N4B04551			
50	N4B05051			
60	N4B06051			
70	N4B07051			
90	N4B09051			
105	N4B10551			
120	N4B12051			

## H 40

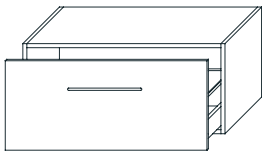

## P 45

Maniglia PONTE & chiusura ammortizzata • base laterale • 1 cassetto  
PONTE Handle & soft-closing • side unit • 1 pull-out  
Poignée PONTE & fermeture amortie • meuble bas latéral • 1 tiroir  
PONTE Griff • Seitenschrank • 1 Soft-Closing Schublade

L		F1	F2	F3
30	N4B03007			
35	N4B03507			
45	N4B04507			
50	N4B05007			
60	N4B06007			
70	N4B07007			
90	N4B09007			
105	N4B10507			
120	N4B12007			

## P 51,5

L		F1	F2	F3
30	N4B03057			
35	N4B03557			
45	N4B04557			
50	N4B05057			
60	N4B06057			
70	N4B07057			
90	N4B09057			
105	N4B10557			
120	N4B12057			

## H 40

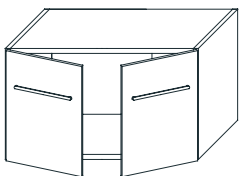

## P 45

Maniglia PONTE & chiusura ammortizzata • base laterale • 2 ante  
PONTE Handle & soft-closing • side unit • 2 doors  
Poignée PONTE & fermeture amortie • meuble bas latéral • 2 portes  
PONTE Griff • Seitenschrank • 2 Türen

L		F1	F2	F3
50	N4B05010			
60	N4B06010			
70	N4B07010			
90	N4B09010			

## P 51,5

L		F1	F2	F3
50	N4B05060			
60	N4B06060			
70	N4B07060			
90	N4B09060			

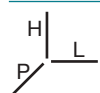

Misure in cm  
Mesures in cm  
Mesures en cm  
Maße in cm

**F1** Laccato opaco  
Matt lacquered  
Laqué mat  
Matt lackiert

**F2** Laccato lucido  
Glossy lacquered  
Laqué brillant  
Hochglanz lackiert

**F3** Nobilitati  
Veneer wood  
Placage bois  
Beschichtetes Holz

**F4** Arock®  
Arock®  
Arock®  
Arock®

**F5** abitat / vogue  
abitat / vogue  
abitat / vogue  
abitat / vogue



# Basi Units

# Meubles bas Unterschränke

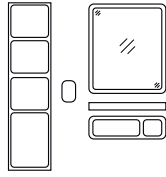

UNICAMENTE  
AROCK®

34

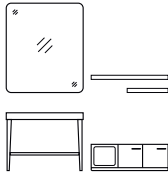

ALCENTIMETRO  
PROGETTO

98

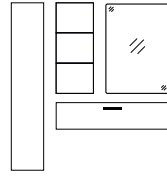

Elementi  
CONTENITORI

180

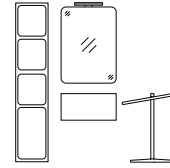

Elementi  
COMPLEMENTARI

226



RICAMBI

592

## H 40

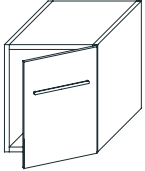

### P 45

Maniglia PONTE & chiusura ammortizzata • base laterale dx • 1 anta  
PONTE Handle & soft-closing • side unit • 1 door  
Poignée PONTE & fermeture amortie • meuble bas latéral • 1 porte  
PONTE Griff • Seitenschrank • 1 Tür

L		F1	F2	F3
30	N4B03008			
35	N4B03508			
45	N4B04508			

### P 51,5

L		F1	F2	F3
30	N4B03058			
35	N4B03558			
45	N4B04558			

## H 40

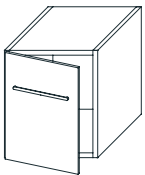

### P 45

Maniglia PONTE & chiusura ammortizzata • base laterale sx • 1 anta  
PONTE Handle & soft-closing • side unit • 1 door  
Poignée PONTE & fermeture amortie • meuble bas latéral • 1 porte  
PONTE Griff • Seitenschrank • 1 Tür

L		F1	F2	F3
30	N4B03009			
35	N4B03509			
45	N4B04509			

### P 51,5

L		F1	F2	F3
30	N4B03059			
35	N4B03559			
45	N4B04559			

## H 50

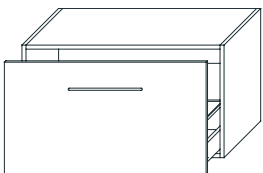

### P 45

Maniglia PONTE & chiusura ammortizzata • base laterale • 1 cassetto + 1 ripiano  
PONTE Handle & soft-closing • side unit • 1 pull-out + 1 shelf  
Poignée PONTE & fermeture amortie • meuble bas latéral • 1 porte + 1 étagère  
PONTE Griff • Seitenschrank • 1 Soft-Closing Schublade + 1 Regal

L		F1	F2	F3
30	N4B03019			
35	N4B03519			
45	N4B04519			
50	N4B05019			
60	N4B06019			
70	N4B07019			
90	N4B09019			
105	N4B10519			
120	N4B12019			

### P 51,5

L		F1	F2	F3
30	N4B03069			
35	N4B03569			
45	N4B04569			
50	N4B05069			
60	N4B06069			
70	N4B07069			
90	N4B09069			
105	N4B10569			
120	N4B12069			



Misure in cm  
Measures in cm  
Mesures en cm  
Maße in cm

**F1** Laccato opaco  
Matt lacquered  
Laqué mat  
Matt lackiert

**F2** Laccato lucido  
Glossy lacquered  
Laqué brillant  
Hochglanz lackiert

**F3** Nobilitati  
Veneer wood  
Placage bois  
Beschichtetes Holz

**F4** Arock®  
Arock®  
Arock®  
Arock®

**F5** abitat / vogue  
abitat / vogue  
abitat / vogue  
abitat / vogue

## Basi Units

## Meubles bas Unterschränke

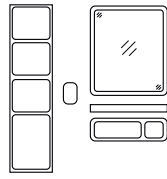

UNICAMENTE  
AROCK®

34

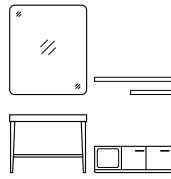

ALCENTIMETRO  
PROGETTO

98

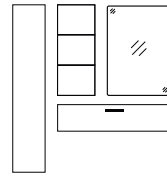

Elementi  
CONTENITORI

180

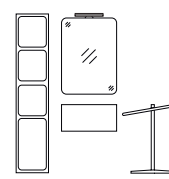

Elementi  
COMPLEMENTARI

226



RICAMBI

592

### H 50

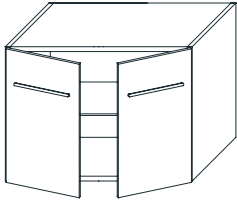

### P 45

Maniglia PONTE & chiusura ammortizzata • base laterale • 2 ante + 1 ripiano  
 PONTE Handle & soft-closing • side unit • 2 doors + 1 shelf  
 Poignée PONTE & fermeture amortie • meuble bas latéral • 2 portes + 1 étagère  
 PONTE Griff • Seitenschrank • 2 Türen + 1 Regal

L		F1	F2	F3
50	N4B05014			
60	N4B06014			
70	N4B07014			
90	N4B09014			

### P 51,5

L		F1	F2	F3
50	N4B05064			
60	N4B06064			
70	N4B07064			
90	N4B09064			

### H 50

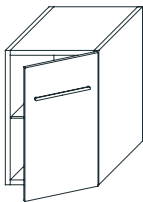

### P 45

Maniglia PONTE & chiusura ammortizzata • base laterale dx • 1 anta + 1 ripiano  
 PONTE Handle & soft-closing • side unit • 1 door + 1 shelf  
 Poignée PONTE & fermeture amortie • meuble bas latéral • 1 porte + 1 étagère  
 PONTE Griff • Seitenschrank • 1 Tür + 1 Regal

L		F1	F2	F3
30	N4B03016			
35	N4B03516			
45	N4B04516			

### P 51,5

L		F1	F2	F3
30	N4B03066			
35	N4B03566			
45	N4B04566			

### H 50

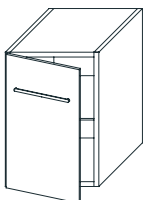

### P 45

Maniglia PONTE & chiusura ammortizzata • base laterale sx • 1 anta + 1 ripiano  
 PONTE Handle & soft-closing • side unit • 1 door + 1 shelf  
 Poignée PONTE & fermeture amortie • meuble bas latéral • 1 porte + 1 étagère  
 PONTE Griff • Seitenschrank • 1 Tür + 1 Regal

L		F1	F2	F3
30	N4B03017			
35	N4B03517			
45	N4B04517			

### P 51,5

L		F1	F2	F3
30	N4B03067			
35	N4B03567			
45	N4B04567			

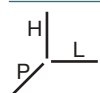

Misure in cm  
 Measures in cm  
 Mesures en cm  
 Maße in cm

**F1** Laccato opaco  
 Matt lacquered  
 Laqué mat  
 Matt lackiert

**F2** Laccato lucido  
 Glossy lacquered  
 Laqué brillant  
 Hochglanz lackiert

**F3** Nobilitati  
 Veneer wood  
 Placage bois  
 Beschichtetes Holz

**F4** Arock®  
 Arock®  
 Arock®  
 Arock®

**F5** abitat / vogue  
 abitat / vogue  
 abitat / vogue  
 abitat / vogue

# Basi Units

# Meubles bas Unterschränke

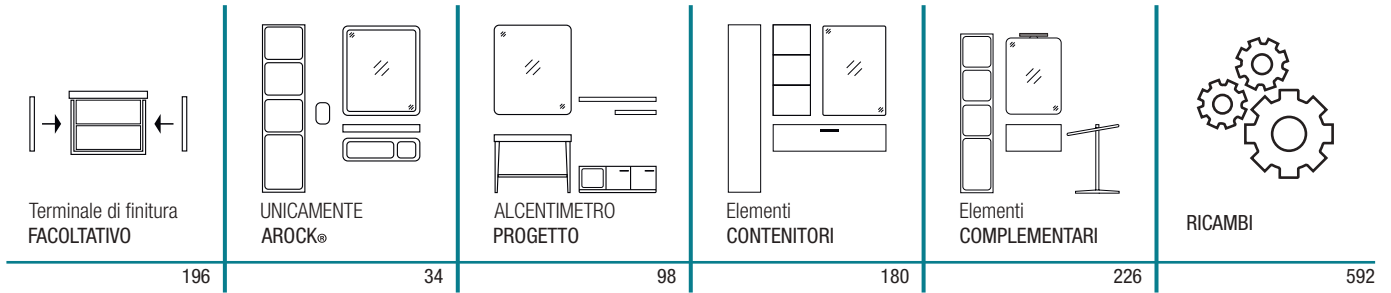

## H 25

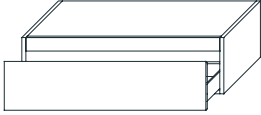

## P 45

Smusso 45° & chiusura ammortizzata • base laterale • 1 cassetto  
Smusso 45° & soft-closing • side unit • 1 pull-out  
Smusso 45° & fermetture amorte • meuble bas latéral • 1 tiroir  
Smusso 45° • Seitenschrank • 1 Soft-Closing Schublade

L		F1	F2	F3
30	N3B03001			
35	N3B03501			
45	N3B04501			
50	N3B05001			
60	N3B06001			
70	N3B07001			
90	N3B09001			
105	N3B10501			
120	N3B12001			

## P 51,5

L		F1	F2	F3
30	N3B03051			
35	N3B03551			
45	N3B04551			
50	N3B05051			
60	N3B06051			
70	N3B07051			
90	N3B09051			
105	N3B10551			
120	N3B12051			

## H 40

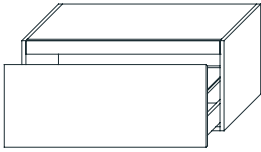

## P 45

Smusso 45° & chiusura ammortizzata • base laterale • 1 cassetto  
Smusso 45° & soft-closing • side unit • 1 pull-out  
Smusso 45° & fermetture amorte • meuble bas latéral • 1 tiroir  
Smusso 45° • Seitenschrank • 1 Soft-Closing Schublade

L		F1	F2	F3
30	N3B03007			
35	N3B03507			
45	N3B04507			
50	N3B05007			
60	N3B06007			
70	N3B07007			
90	N3B09007			
105	N3B10507			
120	N3B12007			

## P 51,5

L		F1	F2	F3
30	N3B03057			
35	N3B03557			
45	N3B04557			
50	N3B05057			
60	N3B06057			
70	N3B07057			
90	N3B09057			
105	N3B10557			
120	N3B12057			

## H 40

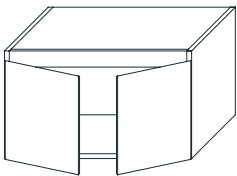

## P 45

Smusso 45° & chiusura ammortizzata • base laterale • 2 ante  
Smusso 45° & soft-closing • side unit • 2 doors  
Smusso 45° & fermetture amorte • meuble bas latéral • 2 portes  
Smusso 45° • Seitenschrank • 2 Türen

L		F1	F2	F3
50	N3B05010			
60	N3B06010			
70	N3B07010			
90	N3B09010			

## P 51,5

L		F1	F2	F3
50	N3B05060			
60	N3B06060			
70	N3B07060			
90	N3B09060			



Misure in cm  
Measures in cm  
Mesures en cm  
Maße in cm

**F1** Laccato opaco  
Matt lacquered  
Laqué mat  
Matt lackiert

**F2** Laccato lucido  
Glossy lacquered  
Laqué brillant  
Hochglanz lackiert





**F3** Nobilitati  
Veneer wood  
Placage bois  
Beschichtetes Holz

**F4** Arock®  
Arock®  
Arock®  
Arock®

**F5** abitat / vogue  
abitat / vogue  
abitat / vogue  
abitat / vogue

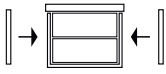
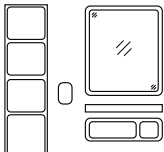
## Basi Units

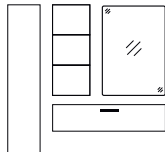
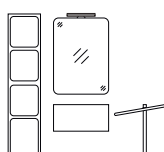
## Meubles bas Unterschränke

					
Terminale di finitura FACOLTATIVO	UNICAMENTE AROCK®	ALCENTIMETRO PROGETTO	Elementi CONTENITORI	Elementi COMPLEMENTARI	RICAMBI
196	34	98	180	226	592

### H 40

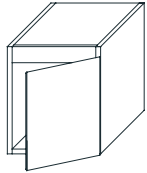

### P 45

Smusso 45° & chiusura ammortizzata • base laterale dx • 1 anta  
 Smusso 45° & soft-closing • side unit • 1 door  
 Smusso 45° & fermeture amortie • meuble bas latéral • 1 tiroir  
 Smusso 45° • Seitenschrank • 1 Tür

L		F1	F2	F3
30	N3B03008			
35	N3B03508			
45	N3B04508			

### P 51,5

L		F1	F2	F3
30	N3B03058			
35	N3B03558			
45	N3B04558			

### H 40

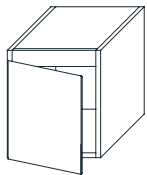

### P 45

Smusso 45° & chiusura ammortizzata • base laterale sx • 1 anta  
 Smusso 45° & soft-closing • side unit • 1 door  
 Smusso 45° & fermeture amortie • meuble bas latéral • 1 tiroir  
 Smusso 45° • Seitenschrank • 1 Tür

L		F1	F2	F3
30	N3B03009			
35	N3B03509			
45	N3B04509			

### P 51,5

L		F1	F2	F3
30	N3B03059			
35	N3B03559			
45	N3B04559			

### H 50

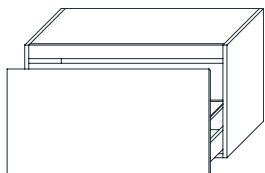

### P 45

Smusso 45° & chiusura ammortizzata • base laterale • 1 cassetto + 1 ripiano  
 Smusso 45° & soft-closing • side unit • 1 pull-out + 1 shelf  
 Smusso 45° & fermeture amortie • meuble bas latéral • 1 tiroir + 1 étagère  
 Smusso 45° • Seitenschrank • 1 Soft-Closing Schublade + 1 Regal

L		F1	F2	F3
30	N3B03019			
35	N3B03519			
45	N3B04519			
50	N3B05019			
60	N3B06019			
70	N3B07019			
90	N3B09019			
105	N3B10519			
120	N3B12019			

### P 51,5

L		F1	F2	F3
30	N3B03069			
35	N3B03569			
45	N3B04569			
50	N3B05069			
60	N3B06069			
70	N3B07069			
90	N3B09069			
105	N3B10569			
120	N3B12069			

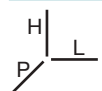

Misure in cm  
 Measures in cm  
 Mesures en cm  
 Maße in cm

**F1** Laccato opaco  
 Matt lacquered  
 Laqué mat  
 Matt lackiert

**F2** Laccato lucido  
 Glossy lacquered  
 Laqué brillant  
 Hochglanz lackiert

**F3** Nobilitati  
 Veneer wood  
 Placage bois  
 Beschichtetes Holz

**F4** Arock®  
 Arock®  
 Arock®  
 Arock®

**F5** abitat / vogue  
 abitat / vogue  
 abitat / vogue  
 abitat / vogue

## Basi Units

## Meubles bas Unterschränke

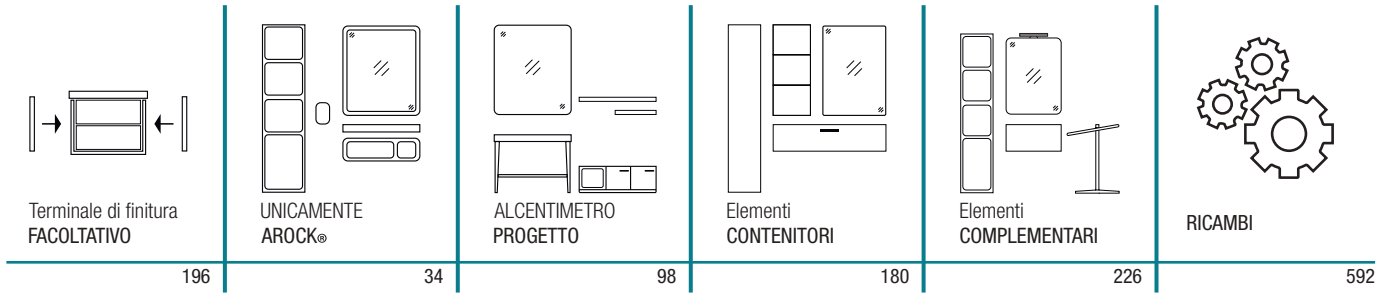

### H 50

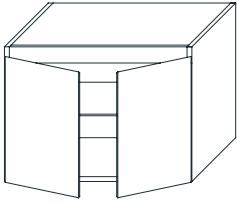

### P 45

Smusso 45° & chiusura ammortizzata • base laterale • 2 ante + 1 ripiano  
 Smusso 45° & soft-closing • side unit • 2 doors + 1 shelf  
 Smusso 45° & fermetture amorte • meuble bas latéral • 2 portes + 1 étagère  
 Smusso 45° • Seitenschrank • 2 Türen + 1 Regal

L		F1	F2	F3
50	N3B05014			
60	N3B06014			
70	N3B07014			
90	N3B09014			

### P 51,5

L		F1	F2	F3
50	N3B05064			
60	N3B06064			
70	N3B07064			
90	N3B09064			

### H 50

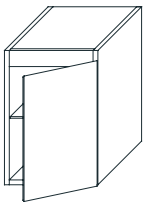

### P 45

Smusso 45° & chiusura ammortizzata • base laterale dx • 1 anta + 1 ripiano  
 Smusso 45° & soft-closing • side unit • 1 door + 1 shelf  
 Smusso 45° & fermetture amorte • meuble bas latéral • 1 porte + 1 étagère  
 Smusso 45° • Seitenschrank • 1 Tür + 1 Regal

L		F1	F2	F3
30	N3B03016			
35	N3B03516			
45	N3B04516			

### P 51,5

L		F1	F2	F3
30	N3B03066			
35	N3B03566			
45	N3B04566			

### H 50

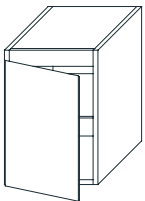

### P 45

Smusso 45° & chiusura ammortizzata • base laterale sx • 1 anta + 1 ripiano  
 Smusso 45° & soft-closing • side unit • 1 door + 1 shelf  
 Smusso 45° & fermetture amorte • meuble bas latéral • 1 porte + 1 étagère  
 Smusso 45° • Seitenschrank • 1 Tür + 1 Regal

L		F1	F2	F3
30	N3B03017			
35	N3B03517			
45	N3B04517			

### P 51,5

L		F1	F2	F3
30	N3B03067			
35	N3B03567			
45	N3B04567			



Misure in cm  
 Measures in cm  
 Mesures en cm  
 Maße in cm

**F1** Laccato opaco  
 Matt lacquered  
 Laqué mat  
 Matt lackiert

**F2** Laccato lucido  
 Glossy lacquered  
 Laqué brillant  
 Hochglanz lackiert

**F3** Nobilitati  
 Veneer wood  
 Placage bois  
 Beschichtetes Holz

**F4** Arock®  
 Arock®  
 Arock®  
 Arock®

**F5** abitat / vogue  
 abitat / vogue  
 abitat / vogue  
 abitat / vogue

# Basi Units

# Meubles bas Unterschränke

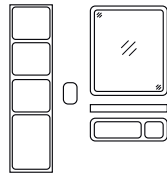

UNICAMENTE  
AROCK®

34

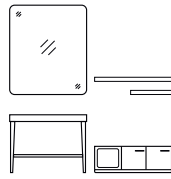

ALCENTIMETRO  
PROGETTO

98

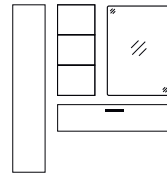

Elementi  
CONTENITORI

180

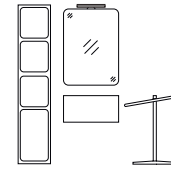

Elementi  
COMPLEMENTARI

226



RICAMBI

592

## H 25

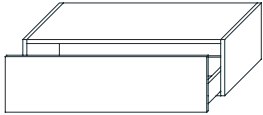

## P 45

Sistema Premi-Apri • base laterale • 1 cassetto  
Premi-Apri System • side unit • 1 pull-out  
Système Premi-Apri • meuble bas latéral • 1 tiroir  
Premi-Apri System • Seitenschrank • 1 Schublade

L		F1	F2	F3
30	N1B03001			
35	N1B03501			
45	N1B04501			
50	N1B05001			
60	N1B06001			
70	N1B07001			
90	N1B09001			
105	N1B10501			
120	N1B12001			

## P 51,5

L		F1	F2	F3
30	N1B03051			
35	N1B03551			
45	N1B04551			
50	N1B05051			
60	N1B06051			
70	N1B07051			
90	N1B09051			
105	N1B10551			
120	N1B12051			

## H 40

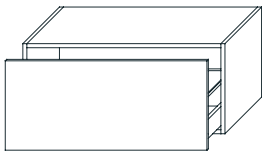

## P 45

Sistema Premi-Apri • base laterale • 1 cassetto  
Premi-Apri System • side unit • 1 pull-out  
Système Premi-Apri • meuble bas latéral • 1 tiroir  
Premi-Apri System • Seitenschrank • 1 Schublade

L		F1	F2	F3
30	N1B03007			
35	N1B03507			
45	N1B04507			
50	N1B05007			
60	N1B06007			
70	N1B07007			
90	N1B09007			
105	N1B10507			
120	N1B12007			

## P 51,5

L		F1	F2	F3
30	N1B03057			
35	N1B03557			
45	N1B04557			
50	N1B05057			
60	N1B06057			
70	N1B07057			
90	N1B09057			
105	N1B10557			
120	N1B12057			

## H 40

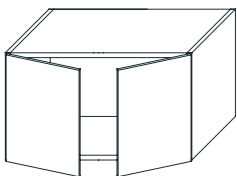

## P 45

Sistema Premi-Apri • base laterale • 2 ante  
Premi-Apri System • side unit • 2 doors  
Système Premi-Apri • meuble bas latéral • 2 portes  
Premi-Apri System • Seitenschrank • 2 Türen

L		F1	F2	F3
50	N1B05010			
60	N1B06010			
70	N1B07010			
90	N1B09010			

## P 51,5

L		F1	F2	F3
50	N1B05060			
60	N1B06060			
70	N1B07060			
90	N1B09060			

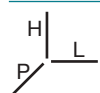

Misure in cm  
Mesures in cm  
Mesures en cm  
Maße in cm

**F1** Laccato opaco  
Matt lacquered  
Laqué mat  
Matt lackiert

**F2** Laccato lucido  
Glossy lacquered  
Laqué brillant  
Hochglanz lackiert

**F3** Nobilitati  
Veneer wood  
Placage bois  
Beschichtetes Holz

**F4** Arock®  
Arock®  
Arock®  
Arock®

**F5** abitat / vogue  
abitat / vogue  
abitat / vogue  
abitat / vogue

# Basi Units

# Meubles bas Unterschränke

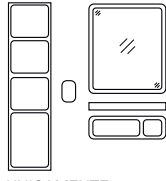

UNICAMENTE  
AROCK®

34

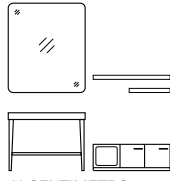

ALCENTIMETRO  
PROGETTO

98

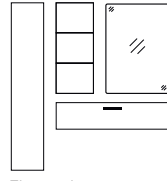

Elementi  
CONTENITORI

180

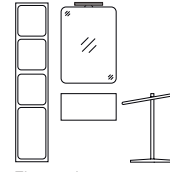

Elementi  
COMPLEMENTARI

226



RICAMBI

592

## H 40

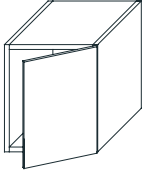

### P 45

Sistema Premi-Apri • base laterale dx • 1 anta  
Premi-Apri System • side unit • 1 door  
Système Premi-Apri • meuble bas latéral • 1 porte  
Premi-Apri System • Seitenschrank • 1 Tür

L		F1	F2	F3
30	N1B03008			
35	N1B03508			
45	N1B04508			

### P 51,5

L		F1	F2	F3
30	N1B03058			
35	N1B03558			
45	N1B04558			

## H 40

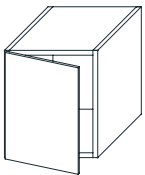

### P 45

Sistema Premi-Apri • base laterale sx • 1 anta  
Premi-Apri System • side unit • 1 door  
Système Premi-Apri • meuble bas latéral • 1 porte  
Premi-Apri System • Seitenschrank • 1 Tür

L		F1	F2	F3
30	N1B03009			
35	N1B03509			
45	N1B04509			

### P 51,5

L		F1	F2	F3
30	N1B03059			
35	N1B03559			
45	N1B04559			

## H 50

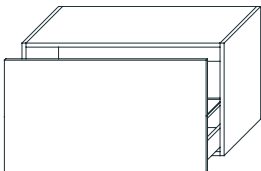

### P 45

Sistema Premi-Apri • base laterale • 1 cassetto + 1 anta  
Premi-Apri System • side unit • 1 pull-out + 1 door  
Système Premi-Apri • meuble bas latéral • 1 tiroir + 1 porte  
Premi-Apri System • Seitenschrank • 1 Schublade + 1 Tür

L		F1	F2	F3
30	N1B03019			
35	N1B03519			
45	N1B04519			
50	N1B05019			
60	N1B06019			
70	N1B07019			
90	N1B09019			
105	N1B10519			
120	N1B12019			

### P 51,5

L		F1	F2	F3
30	N1B03069			
35	N1B03569			
45	N1B04569			
50	N1B05069			
60	N1B06069			
70	N1B07069			
90	N1B09069			
105	N1B10569			
120	N1B12069			



Misure in cm  
Measures in cm  
Mesures en cm  
Maße in cm

**F1** Laccato opaco  
Matt lacquered  
Laqué mat  
Matt lackiert

**F2** Laccato lucido  
Glossy lacquered  
Laqué brillant  
Hochglanz lackiert

**F3** Nobilitati  
Veneer wood  
Placage bois  
Beschichtetes Holz

**F4** Arock®  
Arock®  
Arock®  
Arock®

**F5** abitat / vogue  
abitat / vogue  
abitat / vogue  
abitat / vogue



## Basi Units

## Meubles bas Unterschränke

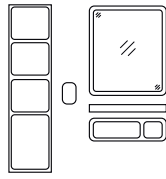

UNICAMENTE  
AROCK®

34

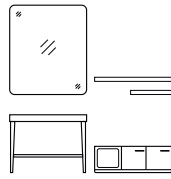

ALCENTIMETRO  
PROGETTO

98

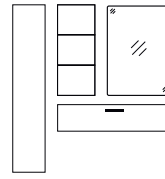

Elementi  
CONTENITORI

180

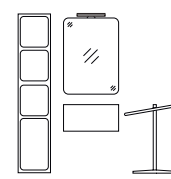

Elementi  
COMPLEMENTARI

226



RICAMBI

592

### H 50

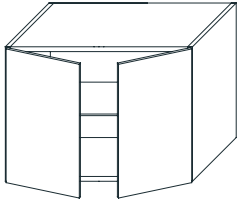

### P 45

Sistema Premi-Api • base laterale • 2 ante + 1 ripiano  
Premi-Api System • side unit • 2 doors + 1 shelf  
Système Premi-Api • meuble bas latéral • 2 portes + 1 étagère  
Premi-Api System • Seitenschrank • 2 Türen + 1 Regal

L		F1	F2	F3
50	N1B05014			
60	N1B06014			
70	N1B07014			
90	N1B09014			

### P 51,5

L		F1	F2	F3
50	N1B05064			
60	N1B06064			
70	N1B07064			
90	N1B09064			

### H 50

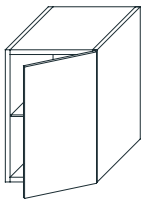

### P 45

Sistema Premi-Api • base laterale dx • 1 anta + 1 ripiano  
Premi-Api System • side unit • 1 door + 1 shelf  
Système Premi-Api • meuble bas latéral • 1 porte + 1 étagère  
Premi-Api System • Seitenschrank • 1 Tür + 1 Regal

L		F1	F2	F3
30	N1B03016			
35	N1B03516			
45	N1B04516			

### P 51,5

L		F1	F2	F3
30	N1B03066			
35	N1B03566			
45	N1B04566			

### H 50

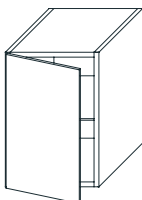

### P 45

Sistema Premi-Api • base laterale sx • 1 anta + 1 ripiano  
Premi-Api System • side unit • 1 door + 1 shelf  
Système Premi-Api • meuble bas latéral • 1 porte + 1 étagère  
Premi-Api System • Seitenschrank • 1 Tür + 1 Regal

L		F1	F2	F3
30	N1B03017			
35	N1B03517			
45	N1B04517			

### P 51,5

L		F1	F2	F3
30	N1B03067			
35	N1B03567			
45	N1B04567			

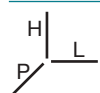

Misure in cm  
Mesures in cm  
Mesures en cm  
Maße in cm

**F1** Laccato opaco  
Matt lacquered  
Laqué mat  
Matt lackiert

**F2** Laccato lucido  
Glossy lacquered  
Laqué brillant  
Hochglanz lackiert

**F3** Nobilitati  
Veneer wood  
Placage bois  
Beschichtetes Holz

**F4** Arock®  
Arock®  
Arock®  
Arock®

**F5** abitat / vogue  
abitat / vogue  
abitat / vogue  
abitat / vogue

## Basi Units

## Meubles bas Unterschranke

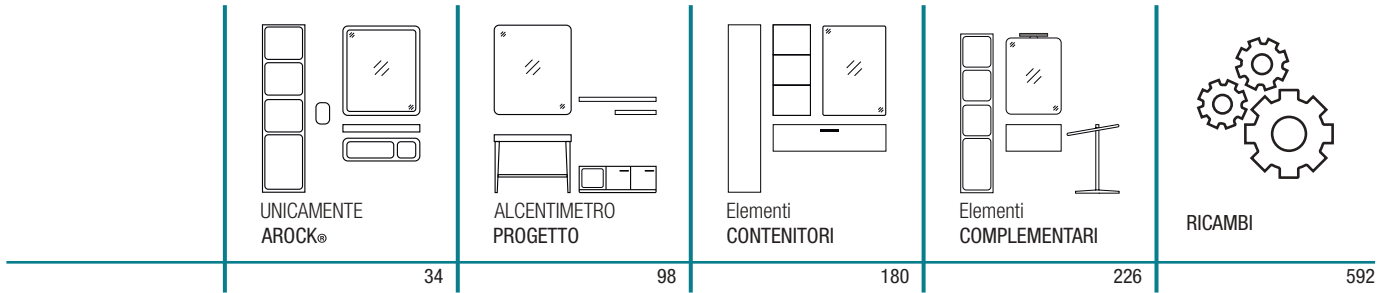

### H 25



### P 45

Pannello terminale - FACOLTATIVO  
Terminal panel - OPTIONAL  
Panueau de finition latéral - OPTIONNEL  
Terminal Panel - OPTIONAL

L	F1	F2	F3
1 LEUFIN05			

### P 51,5

L	F1	F2	F3
1 LEUFIN35			

### H 40

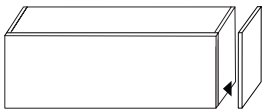

### P 45

Pannello terminale - FACOLTATIVO  
Terminal panel - OPTIONAL  
Panueau de finition latéral - OPTIONNEL  
Terminal Panel - OPTIONAL

L	F1	F2	F3
1 LEUFIN10			

### P 51,5

L	F1	F2	F3
1 LEUFIN40			

### H 50

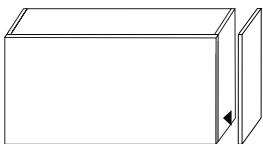

### P 45

Pannello terminale - FACOLTATIVO  
Terminal panel - OPTIONAL  
Panueau de finition latéral - OPTIONNEL  
Terminal Panel - OPTIONAL

L	F1	F2	F3
1 LEUFIN15			

### P 51,5

L	F1	F2	F3
1 LEUFIN45			



Misure in cm  
Measures in cm  
Mesures en cm  
Maße in cm

**F1** Laccato opaco  
Matt lacquered  
Laqué mat  
Matt lackiert

**F2** Laccato lucido  
Glossy lacquered  
Laqué brillant  
Hochglanz lackiert





**F3** Nobilitati  
Veneer wood  
Placage bois  
Beschichtetes Holz

**F4** Arock®  
Arock®  
Arock®  
Arock®

**F5** abitat / vogue  
abitat / vogue  
abitat / vogue  
abitat / vogue

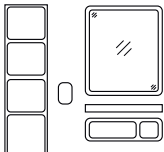
**Basi  
Units**

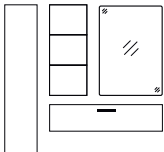
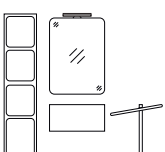
**Meubles bas  
Unterschränke**

 <p>UNICAMENTE AROCK®</p>	 <p>ALCENTIMETRO PROGETTO</p>	 <p>Elementi CONTENITORI</p>	 <p>Elementi COMPLEMENTARI</p>	 <p>RICAMBI</p>
34	98	180	226	592

**H 75**

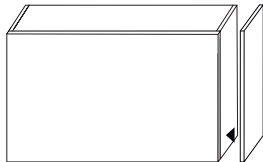

**P 45**

Pannello terminale - FACOLTATIVO  
Terminal panel - OPTIONAL  
Panueau de finition latéral - OPTIONNEL  
Terminal Panel - OPTIONAL

<b>L</b>	<b>F1</b>	<b>F2</b>	<b>F3</b>
1 LEUFIN20			

**P 51,5**

<b>L</b>	<b>F1</b>	<b>F2</b>	<b>F3</b>
1 LEUFIN50			



Misure in cm  
Measures in cm  
Mesures en cm  
Maße in cm

**F1** Laccato opaco  
Matt lacquered  
Laqué mat  
Matt lackiert

**F2** Laccato lucido  
Glossy lacquered  
Laqué brillant  
Hochglanz lackiert

**F3** Nobilitati  
Veneer wood  
Placage bois  
Beschichtetes Holz

**F4** Arock®  
Arock®  
Arock®  
Arock®





**F5** abitat / vogue  
abitat / vogue  
abitat / vogue  
abitat / vogue

BASI D'ARREDO APERTURE GIUSTO

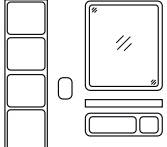

# Basi Units

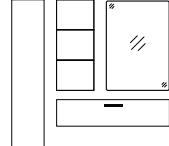
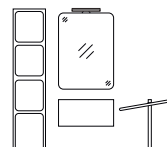
# Meubles bas Unterschränke

				
UNICAMENTE AROCK®	ALCENTIMETRO PROGETTO	Elementi CONTENITORI	Elementi COMPLEMENTARI	RICAMBI
34	98	180	226	592

## H 18,5

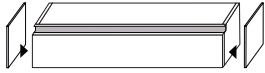

## P 45

Pannelli terminali - OBBLIGATORI  
Terminal panels - REQUIRED  
Paneeux de finition latéral - OPTIONNEL  
Terminal Panele - NÖTIG

L	F1	F2	F3
1 GGUFIN05			

## H 37

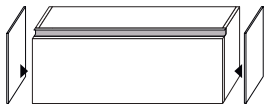

## P 45

Pannelli terminali - OBBLIGATORI  
Terminal panels - REQUIRED  
Paneeux de finition latéral - OBLIGATOIRES  
Terminal Panele - NÖTIG

L	F1	F2	F3
1 GGUFIN10			

## P 51,5

L	F1	F2	F3
1 GGUFIN40			

## H 55,5

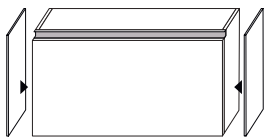

## P 45

Pannelli terminali - OBBLIGATORI  
Terminal panels - REQUIRED  
Paneeux de finition latéral - OBLIGATOIRES  
Terminal Panele - NÖTIG

L	F1	F2	F3
1 GGUFIN15			

## P 51,5

L	F1	F2	F3
1 GGUFIN45			

  
 Misure in cm  
 Measures in cm  
 Mesures en cm  
 Maße in cm

**F1** Laccato opaco  
 Matt lacquered  
 Laqué mat  
 Matt lackiert

**F2** Laccato lucido  
 Glossy lacquered  
 Laqué brillant  
 Hochglanz lackiert

**F3** Nobilitati  
 Veneer wood  
 Placage bois  
 Beschichtetes Holz

**F4** Arock®  
 Arock®  
 Arock®  
 Arock®

**F5** abitat / vogue  
 abitat / vogue  
 abitat / vogue  
 abitat / vogue

## Basi Units

## Meubles bas Unterschränke

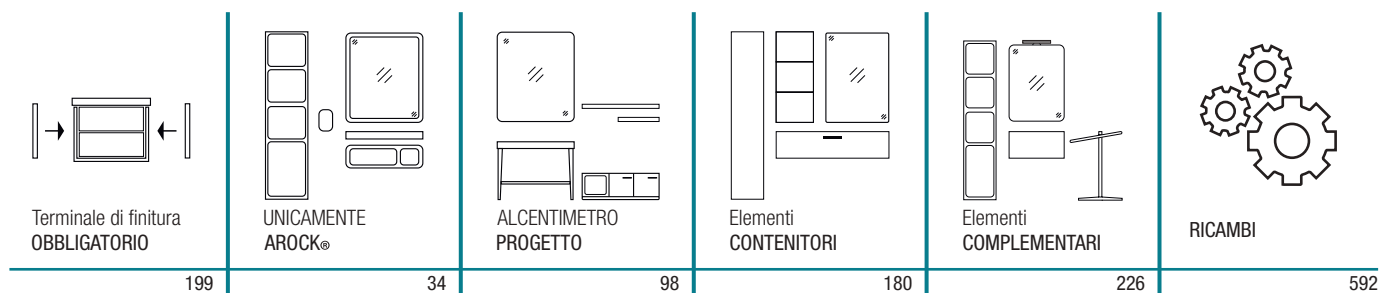

### H 18,5

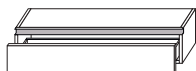

### P 45

Base laterale • 1 cassetto chiusura ammortizzata  
Side unit • 1 soft-closing pull-out  
Meuble bas latéral • 1 tiroir amorti  
Seitenschrank • 1 Soft-Closing Schublade

L		F1	F2	F3
27	GGG02702			
36	GGG03602			
54	GGG05402			
63	GGG06302			
72	GGG07202			
81	GGG08102			
90	GGG09002			
108	GGG10802			

### H 37

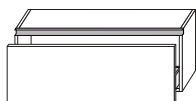

### P 45

Base laterale • 1 cassetto chiusura ammortizzata  
Side unit • 1 soft-closing pull-out  
Meuble bas latéral • 1 tiroir amorti  
Seitenschrank • 1 Soft-Closing Schublade

L		F1	F2	F3
27	GGG02704			
36	GGG03604			
54	GGG05404			
63	GGG06304			
72	GGG07204			
81	GGG08104			
90	GGG09004			
108	GGG10804			

### P 51,5

L		F1	F2	F3
27	GGJ02704			
36	GGJ03604			
54	GGJ05404			
63	GGJ06304			
72	GGJ07204			
81	GGJ08104			
90	GGJ09004			
108	GGJ10804			

### H 55,5

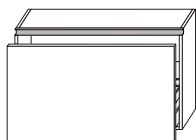

### P 45

Base laterale • 1 cassetto chiusura ammortizzata + 1 ripiano  
Side unit • 1 soft-closing pull-out + 1 shelf  
Meuble bas latéral • 1 tiroir amorti + 1 étagère  
Seitenschrank • 1 Soft-Closing Schublade + 1 Regal

L		F1	F2	F3
27	GGG02706			
36	GGG03606			
54	GGG05406			
63	GGG06306			
72	GGG07206			
81	GGG08106			
90	GGG09006			
108	GGG10806			

### P 51,5

L		F1	F2	F3
27	GGJ02706			
36	GGJ03606			
54	GGJ05406			
63	GGJ06306			
72	GGJ07206			
81	GGJ08106			
90	GGJ09006			
108	GGJ10806			

H  
L  
P

Misure in cm  
Measures in cm  
Mesures en cm  
Maße in cm

**F1** Laccato opaco  
Matt lacquered  
Laqué mat  
Matt lackiert

**F2** Laccato lucido  
Glossy lacquered  
Laqué brillant  
Hochglanz lackiert

**F3** Nobilitati  
Veneer wood  
Placage bois  
Beschichtetes Holz

**F4** Arock®  
Arock®  
Arock®  
Arock®

**F5** abitat / vogue  
abitat / vogue  
abitat / vogue  
abitat / vogue

## Basi Units

## Meubles bas Unterschränke

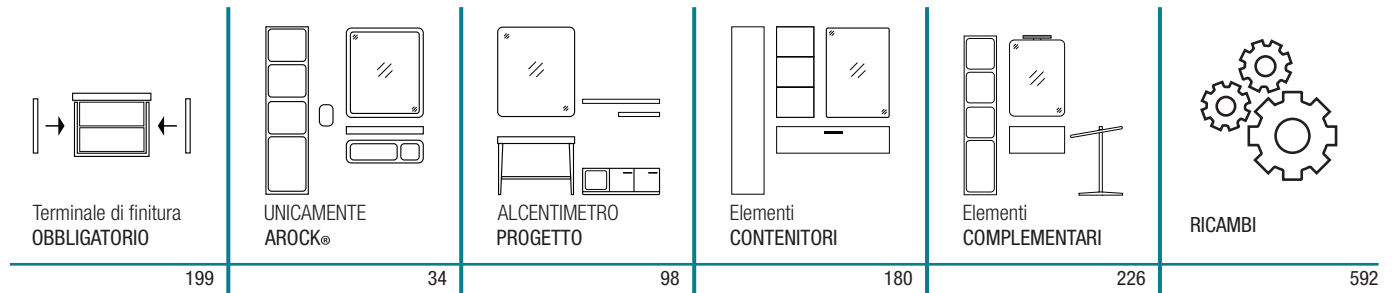

### H 55,5

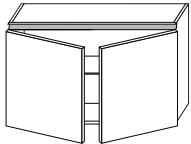

### P 45

Base laterale • 2 ante chiusura ammortizzata + 1 ripiano  
Side unit • 2 soft-closing doors + 1 shelf  
Meuble bas latéral • 2 portes amorties + 1 étagère  
Seitenschrank • 2 Türen + 1 Regal

L		F1	F2	F3
54	GGB05412			
72	GGB07212			
90	GGB09012			
108	GGB10812			

### P 51,5

L		F1	F2	F3
54	GGD05412			
72	GGD07212			
90	GGD09012			
108	GGD10812			

### H 55,5

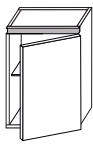

### P 45

Base laterale dx • 1 anta chiusura ammortizzata + 1 ripiano  
Side unit • 1 soft-closing door + 1 shelf  
Meuble bas latéral • 1 porte amortie + 1 étagère  
Seitenschrank • 1 Tür + 1 Regal

L		F1	F2	F3
27	GGB02710			
36	GGB03610			
54	GGB05410			

### P 51,5

L		F1	F2	F3
27	GGD02710			
36	GGD03610			
54	GGD05410			

### H 55,5

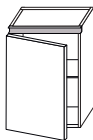

### P 45

Base laterale sx • 1 anta chiusura ammortizzata + 1 ripiano  
Side unit • 1 soft-closing door + 1 shelf  
Meuble bas latéral • 1 porte amortie + 1 étagère  
Seitenschrank • 1 Tür + 1 Regal

L		F1	F2	F3
27	GGB02711			
36	GGB03611			
54	GGB05411			

### P 51,5

L		F1	F2	F3
27	GGD02711			
36	GGD03611			
54	GGD05411			



Misure in cm  
Measures in cm  
Mesures en cm  
Maße in cm

**F1** Laccato opaco  
Matt lacquered  
Laqué mat  
Matt lackiert

**F2** Laccato lucido  
Glossy lacquered  
Laqué brillant  
Hochglanz lackiert

**F3** Nobilitati  
Veneer wood  
Placage bois  
Beschichtetes Holz

**F4** Arock®  
Arock®  
Arock®  
Arock®

**F5** abitat / vogue  
abitat / vogue  
abitat / vogue  
abitat / vogue



PENSILI CON ANTA SPECCHIATA E PENSILI









tutti i PENSILI CON ANTA A SPECCHIO

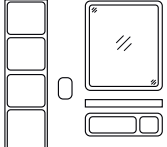

## Pensili Wall cabinets

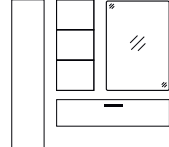
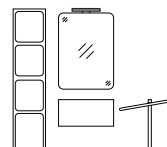
## Éléments hauts Halbhochschränke

				
UNICAMENTE AROCK®	ALCENTIMETRO PROGETTO	Elementi CONTENITORI	Elementi COMPLEMENTARI	RICAMBI
34	98	180	226	592

### H 75

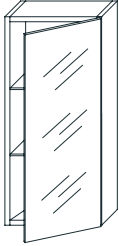

### P 18

Sistema Premi-Apri • pensile dx • 1 anta specchiata  
Premi-Apri System • mirrored wall cabinet • 1 door  
Système Premi-Apri • armoire de toilette • 1 porte  
Premi-Apri System • Spiegelschrank • 1 Tür

L	F1	F2	F3
30	N5P03030		
35	N5P03530		
45	N5P04530		

### H 75

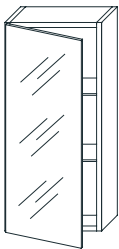

### P 18

Sistema Premi-Apri • pensile sx • 1 anta specchiata  
Premi-Apri System • mirrored wall cabinet • 1 door  
Système Premi-Apri • armoire de toilette • 1 porte  
Premi-Apri System • Spiegelschrank • 1 Tür

L	F1	F2	F3
30	N5P03031		
35	N5P03531		
45	N5P04531		

H  
L  
P

Misure in cm  
Measures in cm  
Mesures en cm  
Maße in cm

**F1** Laccato opaco  
Matt lacquered  
Laqué mat  
Matt lackiert

**F2** Laccato lucido  
Glossy lacquered  
Laqué brillant  
Hochglanz lackiert

**F3** Nobilitati  
Veneer wood  
Placage bois  
Beschichtetes Holz

**F4** Arock®  
Arock®  
Arock®  
Arock®

**F5** abitat / vogue  
abitat / vogue  
abitat / vogue  
abitat / vogue

## Pensili Wall cabinets

## Éléments hauts Halbhochschränke

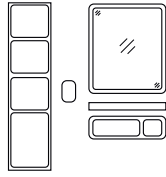

UNICAMENTE  
AROCK®

34

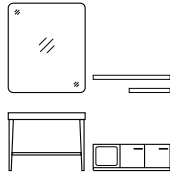

ALCENTIMETRO  
PROGETTO

98

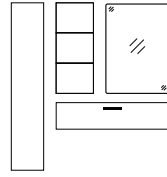

Elementi  
CONTENITORI

180

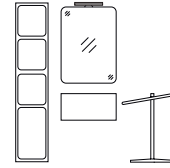

Elementi  
COMPLEMENTARI

226



RICAMBI

592

### H 40

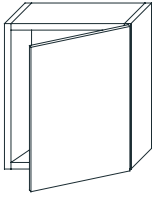

### P 18

Sistema Premi-Apri • pensile dx • 1 anta  
Premi-Apri System • wall cabinet • 1 door  
Système Premi-Apri • élément haut • 1 porte  
Premi-Apri System • Halbhochschrank • 1 Tür

L		F1	F2	F3
30	N1P03002			
35	N1P03502			
45	N1P04502			

### H 40

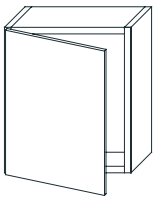

### P 18

Sistema Premi-Apri • pensile sx • 1 anta  
Premi-Apri System • wall cabinet • 1 door  
Système Premi-Apri • élément haut • 1 porte  
Premi-Apri System • Halbhochschrank • 1 Tür

L		F1	F2	F3
30	N1P03003			
35	N1P03503			
45	N1P04503			

### H 40

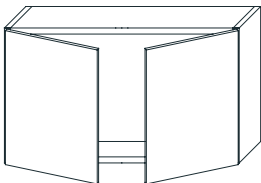

### P 18

Sistema Premi-Apri • pensile • 2 ante  
Premi-Apri System • wall cabinet • 2 doors  
Système Premi-Apri • élément haut • 2 portes  
Premi-Apri System • Halbhochschrank • 2 Türen

L		F1	F2	F3
60	N1P06004			
70	N1P07004			
90	N1P09004			



Misure in cm  
Measures in cm  
Mesures en cm  
Maße in cm

**F1** Laccato opaco  
Matt lacquered  
Laqué mat  
Matt lackiert

**F2** Laccato lucido  
Glossy lacquered  
Laqué brillant  
Hochglanz lackiert

**F3** Nobilitati  
Veneer wood  
Placage bois  
Beschichtetes Holz

**F4** Arock®  
Arock®  
Arock®  
Arock®

**F5** abitat / vogue  
abitat / vogue  
abitat / vogue  
abitat / vogue

## Pensili Wall cabinets

## Éléments hauts Halbhochschränke

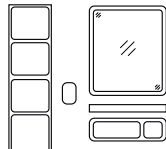

UNICAMENTE  
AROCK®

34

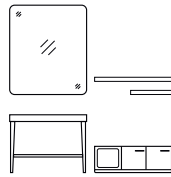

ALCENTIMETRO  
PROGETTO

98

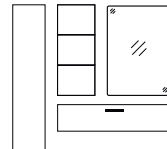

Elementi  
CONTENITORI

180

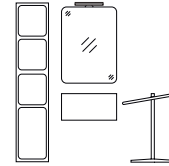

Elementi  
COMPLEMENTARI

226



RICAMBI

592

### H 50

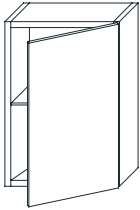

### P 18

Sistema Premi-Apri • pensile dx • 1 anta + 1 ripiano  
Premi-Apri System • wall cabinet • 1 door + 1 shelf  
Système Premi-Apri • élément haut • 1 porte + 1 étagère  
Premi-Apri System • Halbhochschrank • 1 Tür + 1 Regal

L		F1	F2	F3
30	N1P03006			
35	N1P03506			
45	N1P04506			

### H 50

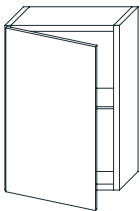

### P 18

Sistema Premi-Apri • pensile sx • 1 anta + 1 ripiano  
Premi-Apri System • wall cabinet • 1 door + 1 shelf  
Système Premi-Apri • élément haut • 1 porte + 1 étagère  
Premi-Apri System • Halbhochschrank • 1 Tür + 1 Regal

L		F1	F2	F3
30	N1P03007			
35	N1P03507			
45	N1P04507			

### H 50

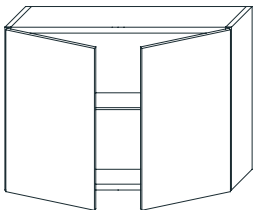

### P 18

Sistema Premi-Apri • pensile • 2 ante + 1 ripiano  
Premi-Apri System • wall cabinet • 2 doors + 1 shelf  
Système Premi-Apri • élément haut • 2 portes + 1 étagère  
Premi-Apri System • Halbhochschrank • 2 Türen + 1 Regal

L		F1	F2	F3
60	N1P06008			
70	N1P07008			
90	N1P09008			

H  
L  
P

Misure in cm  
Measures in cm  
Mesures en cm  
Maße in cm

**F1** Laccato opaco  
Matt lacquered  
Laqué mat  
Matt lackiert

**F2** Laccato lucido  
Glossy lacquered  
Laqué brillant  
Hochglanz lackiert

**F3** Nobilitati  
Veneer wood  
Placage bois  
Beschichtetes Holz

**F4** Arock®  
Arock®  
Arock®  
Arock®

**F5** abitat / vogue  
abitat / vogue  
abitat / vogue  
abitat / vogue

## Pensili Wall cabinets

## Éléments hauts Halbhochschränke

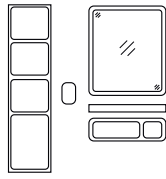

UNICAMENTE  
AROCK®

34

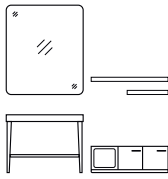

ALCENTIMETRO  
PROGETTO

98

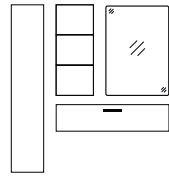

Elementi  
CONTENTORI

180

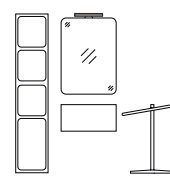

Elementi  
COMPLEMENTARI

226



RICAMBI

592

### H 65

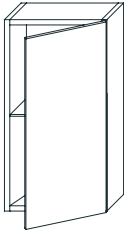

### P 18

Sistema Premi-Apri • pensile dx • 1 anta + 1 ripiano  
Premi-Apri System • wall cabinet • 1 door + 1 shelf  
Système Premi-Apri • élément haut • 1 porte + 1 étagère  
Premi-Apri System • Halbhochschrank • 1 Tür + 1 Regal

L		F1	F2	F3
30	N1P03010			
35	N1P03510			
45	N1P04510			

### H 65

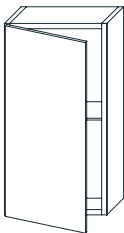

### P 18

Sistema Premi-Apri • pensile sx • 1 anta + 1 ripiano  
Premi-Apri System • wall cabinet • 1 door + 1 shelf  
Système Premi-Apri • élément haut • 1 porte + 1 étagère  
Premi-Apri System • Halbhochschrank • 1 Tür + 1 Regal

L		F1	F2	F3
30	N1P03011			
35	N1P03511			
45	N1P04511			

### H 65

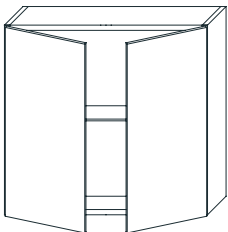

### P 18

Sistema Premi-Apri • pensile • 2 ante + 1 ripiano  
Premi-Apri System • wall cabinet • 2 doors + 1 shelf  
Système Premi-Apri • élément haut • 2 portes + 1 étagère  
Premi-Apri System • Halbhochschrank • 2 Türen + 1 Regal

L		F1	F2	F3
60	N1P06012			
70	N1P07012			
90	N1P09012			

H  
L  
P

Misure in cm  
Measures in cm  
Mesures en cm  
Maße in cm

**F1** Laccato opaco  
Matt lacquered  
Laqué mat  
Matt lackiert

**F2** Laccato lucido  
Glossy lacquered  
Laqué brillant  
Hochglanz lackiert

**F3** Nobilitati  
Veneer wood  
Placage bois  
Beschichtetes Holz

**F4** Arock®  
Arock®  
Arock®  
Arock®

**F5** abitat / vogue  
abitat / vogue  
abitat / vogue  
abitat / vogue



## Pensili Wall cabinets

## Éléments hauts Halbhochschränke

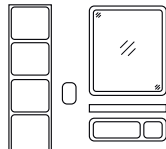

UNICAMENTE  
AROCK®

34

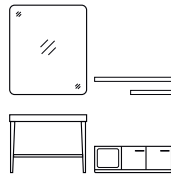

ALCENTIMETRO  
PROGETTO

98

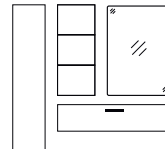

Elementi  
CONTENITORI

180

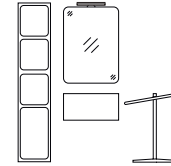

Elementi  
COMPLEMENTARI

226



RICAMBI

592

### H 75

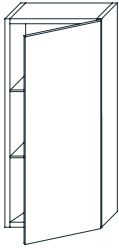

### P 18

Sistema Premi-Apri • pensile dx • 1 anta + 2 ripiani  
Premi-Apri System • wall cabinet • 1 door + 2 shelves  
Système Premi-Apri • élément haut • 1 porte + 2 étagères  
Premi-Apri System • Halbhochschrank • 1 Tür + 2 Regale

L		F1	F2	F3
30	N1P03014			
35	N1P03514			
45	N1P04514			

### H 75

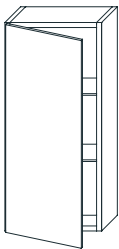

### P 18

Sistema Premi-Apri • pensile sx • 1 anta + 2 ripiani  
Premi-Apri System • wall cabinet • 1 door + 2 shelves  
Système Premi-Apri • élément haut • 1 porte + 2 étagères  
Premi-Apri System • Halbhochschrank • 1 Tür + 2 Regale

L		F1	F2	F3
30	N1P03015			
35	N1P03515			
45	N1P04515			

### H 75

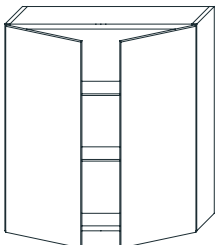

### P 18

Sistema Premi-Apri • pensile • 2 ante + 2 ripiani  
Premi-Apri System • wall cabinet • 2 doors + 2 shelves  
Système Premi-Apri • élément haut • 2 portes + 2 étagères  
Premi-Apri System • Halbhochschrank • 2 Türen + 2 Regale

L		F1	F2	F3
60	N1P06016			
70	N1P07016			
90	N1P09016			

H  
L  
P

Misure in cm  
Measures in cm  
Mesures en cm  
Maße in cm

**F1** Laccato opaco  
Matt lacquered  
Laqué mat  
Matt lackiert

**F2** Laccato lucido  
Glossy lacquered  
Laqué brillant  
Hochglanz lackiert

**F3** Nobilitati  
Veneer wood  
Placage bois  
Beschichtetes Holz

**F4** Arock®  
Arock®  
Arock®  
Arock®

**F5** abitat / vogue  
abitat / vogue  
abitat / vogue  
abitat / vogue

## Pensili Wall cabinets

## Éléments hauts Halbhochschränke

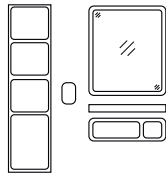

UNICAMENTE  
AROCK®

34

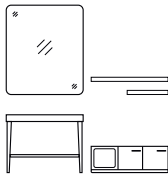

ALCENTIMETRO  
PROGETTO

98



Elementi  
CONTENITORI

180

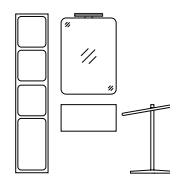

Elementi  
COMPLEMENTARI

226



RICAMBI

592

### H 90

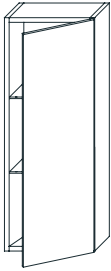

### P 18

Sistema Premi-Apri • pensile dx • 1 anta + 2 ripiani  
Premi-Apri System • wall cabinet • 1 door + 2 shelves  
Système Premi-Apri • élément haut • 1 porte + 2 étagères  
Premi-Apri System • Halbhochschrank • 1 Tür + 2 Regale

L		F1	F2	F3
30	N1P03018			
35	N1P03518			
45	N1P04518			

### H 90

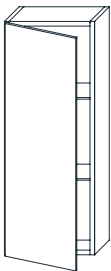

### P 18

Sistema Premi-Apri • pensile sx • 1 anta + 2 ripiani  
Premi-Apri System • wall cabinet • 1 door + 2 shelves  
Système Premi-Apri • élément haut • 1 porte + 2 étagères  
Premi-Apri System • Halbhochschrank • 1 Tür + 2 Regale

L		F1	F2	F3
30	N1P03019			
35	N1P03519			
45	N1P04519			

### H 90

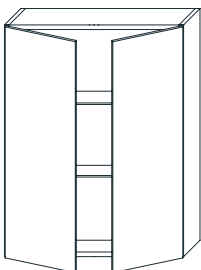

### P 18

Sistema Premi-Apri • pensile • 2 ante + 2 ripiani  
Premi-Apri System • wall cabinet • 2 doors + 2 shelves  
Système Premi-Apri • élément haut • 2 portes + 2 étagères  
Premi-Apri System • Halbhochschrank • 2 Türen + 2 Regale

L		F1	F2	F3
60	N1P06020			
70	N1P07020			
90	N1P09020			



Misure in cm  
Measures in cm  
Mesures en cm  
Maße in cm

**F1** Laccato opaco  
Matt lacquered  
Laqué mat  
Matt lackiert

**F2** Laccato lucido  
Glossy lacquered  
Laqué brillant  
Hochglanz lackiert

**F3** Nobilitati  
Veneer wood  
Placage bois  
Beschichtetes Holz

**F4** Arock®  
Arock®  
Arock®  
Arock®

**F5** abitat / vogue  
abitat / vogue  
abitat / vogue  
abitat / vogue







## Pensili a giorno Wall shelving units

## Demi-colonnes murales ouvertes Regalelemente

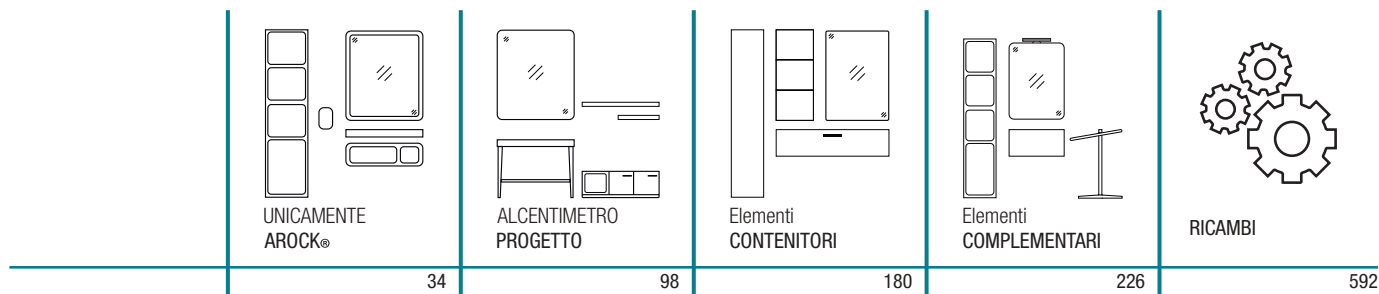

### H 40

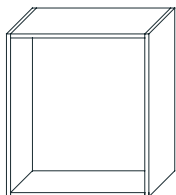

### P 18

Pensile a giorno  
Wall shelving unit  
Demi-colonne murale ouverte  
Regalelement

L	F1	F2	F3
30	N5P03012		
35	N5P03512		
45	N5P04512		

### H 50

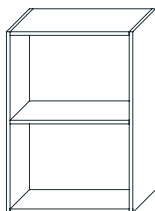

### P 18

Pensile a giorno • 2 vani  
Wall shelving unit • 2 compartments  
Demi-colonne murale ouverte • 2 compartiments  
Regalelement • 2 Fächer

L	F1	F2	F3
30	N5P03026		
35	N5P03526		
45	N5P04526		

### H 65

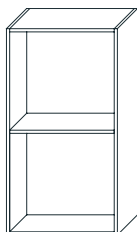

### P 18

Pensile a giorno • 2 vani  
Wall shelving unit • 2 compartments  
Demi-colonne murale ouverte • 2 compartiments  
Regalelement • 2 Fächer

L	F1	F2	F3
30	N5P03028		
35	N5P03528		
45	N5P04528		



Misure in cm  
Measures in cm  
Mesures en cm  
Maße in cm

**F1** Laccato opaco  
Matt lacquered  
Laqué mat  
Matt lackiert

**F2** Laccato lucido  
Glossy lacquered  
Laqué brillant  
Hochglanz lackiert

**F3** Nobilitati  
Veneer wood  
Placage bois  
Beschichtetes Holz

**F4** Arock®  
Arock®  
Arock®  
Arock®





**F5** abitat / vogue  
abitat / vogue  
abitat / vogue  
abitat / vogue

## Pensili a giorno

### Wall shelving units

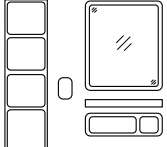
## Demi-colonne murales ouvertes

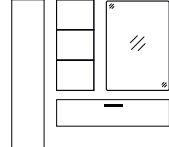
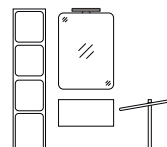
### Regalelemente

				
UNICAMENTE AROCK®	ALCENTIMETRO PROGETTO	Elementi CONTENITORI	Elementi COMPLEMENTARI	RICAMBI
34	98	180	226	592

#### H 75

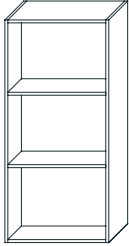

#### P 18

Pensile a giorno • 3 vani  
Wall shelving unit • 3 compartments  
Demi-colonne murale ouverte • 3 compartiments  
Regalelement • 3 Fächer

L	F1	F2	F3
30 N5P03032			
35 N5P03532			
45 N5P04532			

#### H 90

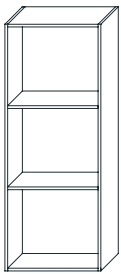

#### P 18

Pensile a giorno • 3 vani  
Wall shelving unit • 3 compartments  
Demi-colonne murale ouverte • 3 compartiments  
Regalelement • 3 Fächer

L	F1	F2	F3
30 N5P03016			
35 N5P03516			
45 N5P04516			



Misure in cm  
Measures in cm  
Mesures en cm  
Maße in cm

**F1** Laccato opaco  
Matt lacquered  
Laqué mat  
Matt lackiert

**F2** Laccato lucido  
Glossy lacquered  
Laqué brillant  
Hochglanz lackiert

**F3** Nobilitati  
Veneer wood  
Placage bois  
Beschichtetes Holz

**F4** Arock®  
Arock®  
Arock®  
Arock®

**F5** abitat / vogue  
abitat / vogue  
abitat / vogue  
abitat / vogue



TUTTE LE COLONNE



## Colonne Tall cabinets

## Armoires hautes-murales Hochschränke

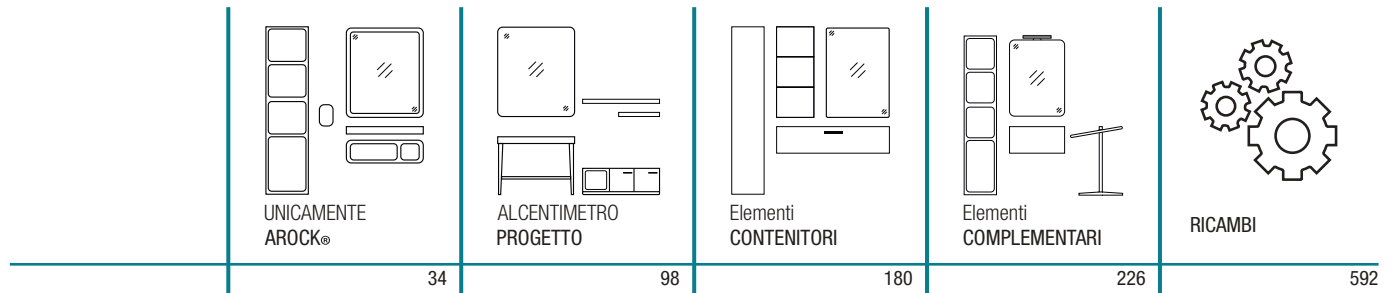

### H 100

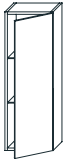

### P 18

Colonna dx • 1 anta chiusura ammortizzata + 2 ripiani  
Tall cabinet • 1 soft-closing door + 2 shelves  
Armoire haute-murale • 1 porte amortie + 2 étagères  
Hochschrank • 1 Tür + 2 Regale

L		F1	F2	F3
30	N1C03002			
35	N1C03502			
45	N1C04502			

### P 34

L		F1	F2	F3
30	N1C03052			
35	N1C03552			
45	N1C04552			

### H 100



### P 18

Colonna sx • 1 anta chiusura ammortizzata + 2 ripiani  
Tall cabinet • 1 soft-closing door + 2 shelves  
Armoire haute-murale • 1 porte amortie + 2 étagères  
Hochschrank • 1 Tür + 2 Regale

L		F1	F2	F3
30	N1C03003			
35	N1C03503			
45	N1C04503			

### P 34

L		F1	F2	F3
30	N1C03053			
35	N1C03553			
45	N1C04553			

### H 100

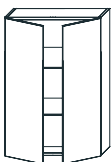

### P 18

Colonna • 2 ante chiusura ammortizzata + 2 ripiani  
Tall cabinet • 2 soft-closing doors + 2 shelves  
Armoire haute-murale • 2 portes amorties + 2 étagères  
Hochschrank • 2 Türen + 2 Regale

L		F1	F2	F3
60	N1C06004			
70	N1C07004			

### P 34

L		F1	F2	F3
60	N1C06054			
70	N1C07054			

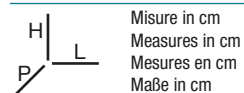

Misure in cm  
Measures in cm  
Mesures en cm  
Maße in cm

**F1** Laccato opaco  
Matt lacquered  
Laqué mat  
Matt lackiert

**F2** Laccato lucido  
Glossy lacquered  
Laqué brillant  
Hochglanz lackiert

**F3** Nobilitati  
Veneer wood  
Placage bois  
Beschichtetes Holz

**F4** Arock®  
Arock®  
Arock®  
Arock®

**F5** abitat / vogue  
abibat / vogue  
abibat / vogue  
abibat / vogue

## Colonne Tall cabinets

## Armoires hautes-murales Hochschränke

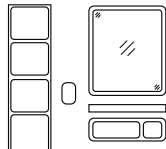

UNICAMENTE  
AROCK®

34

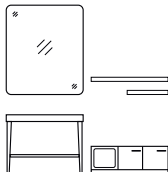

ALCENTIMETRO  
PROGETTO

98

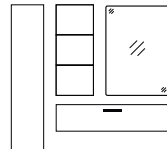

Elementi  
CONTENITORI

180

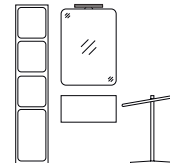

Elementi  
COMPLEMENTARI

226



RICAMBI

592

### H 125



### P 18

Colonna dx • 1 anta chiusura ammortizzata + 3 ripiani  
Tall cabinet • 1 soft-closing door + 3 shelves  
Armoire haute-murale • 1 porte amortie + 3 étagères  
Hochschrank • 1 Tür + 3 Regale

L		F1	F2	F3
30	N1C03006			
35	N1C03506			
45	N1C04506			

### P 34

L		F1	F2	F3
30	N1C03056			
35	N1C03556			
45	N1C04556			

### H 125



### P 18

Colonna sx • 1 anta chiusura ammortizzata + 3 ripiani  
Tall cabinet • 1 soft-closing door + 3 shelves  
Armoire haute-murale • 1 porte amortie + 3 étagères  
Hochschrank • 1 Tür + 3 Regale

L		F1	F2	F3
30	N1C03007			
35	N1C03507			
45	N1C04507			

### P 34

L		F1	F2	F3
30	N1C03057			
35	N1C03557			
45	N1C04557			

### H 125

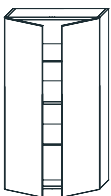

### P 18

Colonna • 2 ante chiusura ammortizzata + 3 ripiani  
Tall cabinet • 2 soft-closing doors + 3 shelves  
Armoire haute-murale • 2 portes amorties + 3 étagères  
Hochschrank • 2 Türen + 3 Regale

L		F1	F2	F3
60	N1C06008			
70	N1C07008			

### P 34

L		F1	F2	F3
60	N1C06058			
70	N1C07058			



Misure in cm  
Measures in cm  
Mesures en cm  
Maße in cm

**F1** Laccato opaco  
Matt lacquered  
Laqué mat  
Matt lackiert

**F2** Laccato lucido  
Glossy lacquered  
Laqué brillant  
Hochglanz lackiert

**F3** Nobilitati  
Veneer wood  
Placage bois  
Beschichtetes Holz

**F4** Arock®  
Arock®  
Arock®  
Arock®

**F5** abitat / vogue  
abitat / vogue  
abitat / vogue  
abitat / vogue

## Colonne Tall cabinets

## Armoires hautes-murales Hochschränke

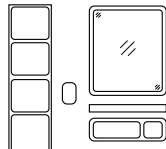

UNICAMENTE  
AROCK®

34

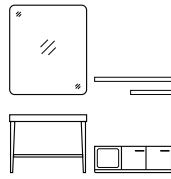

ALCENTIMETRO  
PROGETTO

98

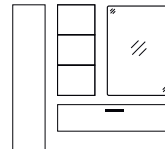

Elementi  
CONTENITORI

180

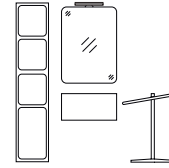

Elementi  
COMPLEMENTARI

226



RICAMBI

592

### H 140



### P 18

Colonna dx • 1 anta chiusura ammortizzata + 3 ripiani  
Tall cabinet • 1 soft-closing door + 3 shelves  
Armoire haute-murale • 1 porte amortie + 3 étagères  
Hochschrank • 1 Tür + 3 Regale

L		F1	F2	F3
30	N1C03010			
35	N1C03510			
45	N1C04510			

### P 34

L		F1	F2	F3
30	N1C03060			
35	N1C03560			
45	N1C04560			

### H 140



### P 18

Colonna sx • 1 anta chiusura ammortizzata + 3 ripiani  
Tall cabinet • 1 soft-closing door + 3 shelves  
Armoire haute-murale • 1 porte amortie + 3 étagères  
Hochschrank • 1 Tür + 3 Regale

L		F1	F2	F3
30	N1C03011			
35	N1C03511			
45	N1C04511			

### P 34

L		F1	F2	F3
30	N1C03061			
35	N1C03561			
45	N1C04561			

### H 140

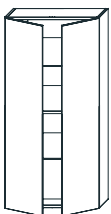

### P 18

Colonna • 2 ante chiusura ammortizzata + 3 ripiani  
Tall cabinet • 2 soft-closing doors + 3 shelves  
Armoire haute-murale • 2 portes amorties + 3 étagères  
Hochschrank • 2 Türen + 3 Regale

L		F1	F2	F3
60	N1C06012			
70	N1C07012			

### P 34

L		F1	F2	F3
60	N1C06062			
70	N1C07062			

H  
L  
P

Misure in cm  
Measures in cm  
Mesures en cm  
Maße in cm

**F1** Laccato opaco  
Matt lacquered  
Laqué mat  
Matt lackiert

**F2** Laccato lucido  
Glossy lacquered  
Laqué brillant  
Hochglanz lackiert

**F3** Nobilitati  
Veneer wood  
Placage bois  
Beschichtetes Holz

**F4** Arock®  
Arock®  
Arock®  
Arock®

**F5** abitat / vogue  
abitat / vogue  
abitat / vogue  
abitat / vogue

## Colonne Tall cabinets

## Armoires hautes-murales Hochschränke

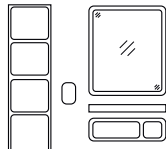

UNICAMENTE  
AROCK®

34



ALCENTIMETRO  
PROGETTO

98

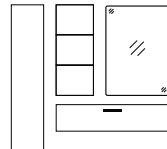

Elementi  
CONTENITORI

180

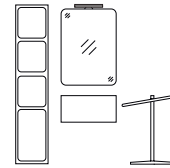

Elementi  
COMPLEMENTARI

226



RICAMBI

592

### H 175



### P 18

Colonna dx • 1 anta chiusura ammortizzata + 4 ripiani  
Tall cabinet • 1 soft-closing door + 4 shelves  
Armoire haute-murale • 1 porte amortie + 4 étagères  
Hochschrank • 1 Tür + 4 Regale

L		F1	F2	F3
30	N1C03014			
35	N1C03514			
45	N1C04514			

### P 34

L		F1	F2	F3
30	N1C03064			
35	N1C03564			
45	N1C04564			

### P 175



### P 18

Colonna sx • 1 anta chiusura ammortizzata + 4 ripiani  
Tall cabinet • 1 soft-closing door + 4 shelves  
Armoire haute-murale • 1 porte amortie + 4 étagères  
Hochschrank • 1 Tür + 4 Regale

L		F1	F2	F3
30	N1C03015			
35	N1C03515			
45	N1C04515			

### P 34

L		F1	F2	F3
30	N1C03065			
35	N1C03565			
45	N1C04565			

### H 175

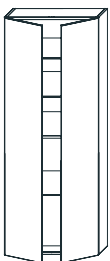

### P 18

Colonna • 2 ante chiusura ammortizzata + 4 ripiani  
Tall cabinet • 2 soft-closing doors + 4 shelves  
Armoire haute-murale • 2 portes amorties + 4 étagères  
Hochschrank • 2 Türen + 4 Regale

L		F1	F2	F3
60	N1C06016			
70	N1C07016			

### P 34

L		F1	F2	F3
60	N1C06066			
70	N1C07066			



Misure in cm  
Measures in cm  
Mesures en cm  
Maße in cm

**F1** Laccato opaco  
Matt lacquered  
Laqué mat  
Matt lackiert

**F2** Laccato lucido  
Glossy lacquered  
Laqué brillant  
Hochglanz lackiert

**F3** Nobilitati  
Veneer wood  
Placage bois  
Beschichtetes Holz

**F4** Arock®  
Arock®  
Arock®  
Arock®

**F5** abitat / vogue  
abitat / vogue  
abitat / vogue  
abitat / vogue

## Colonne Tall cabinets

## Armoires hautes-murales Hochschränke

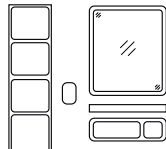

UNICAMENTE  
AROCK®

34

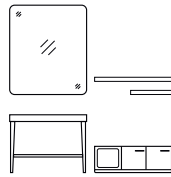

ALCENTIMETRO  
PROGETTO

98

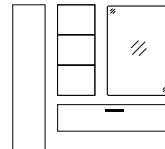

Elementi  
CONTENITORI

180

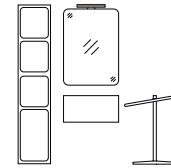

Elementi  
COMPLEMENTARI

226



RICAMBI

592

### H 188



### P 18

Colonna dx • 1 anta chiusura ammortizzata + 4 ripiani  
Tall cabinet • 1 soft-closing door + 4 shelves  
Armoire haute-murale • 1 porte amortie + 4 étagères  
Hochschrank • 1 Tür + 4 Regale

L		F1	F2	F3
30	N1C03018			
35	N1C03518			
45	N1C04518			

### P 34

L		F1	F2	F3
30	N1C03068			
35	N1C03568			
45	N1C04568			

### H 188



### P 18

Colonna sx • 1 anta chiusura ammortizzata + 4 ripiani  
Tall cabinet • 1 soft-closing door + 4 shelves  
Armoire haute-murale • 1 porte amortie + 4 étagères  
Hochschrank • 1 Tür + 4 Regale

L		F1	F2	F3
30	N1C03019			
35	N1C03519			
45	N1C04519			

### P 34

L		F1	F2	F3
30	N1C03069			
35	N1C03569			
45	N1C04569			

### H 188

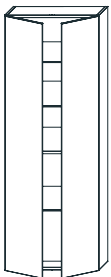

### P 18

Colonna • 2 ante chiusura ammortizzata + 4 ripiani  
Tall cabinet • 2 soft-closing doors + 4 shelves  
Armoire haute-murale • 2 portes amorties + 4 étagères  
Hochschrank • 2 Türen + 4 Regale

L		F1	F2	F3
60	N1C06020			
70	N1C07020			

### P 34

L		F1	F2	F3
60	N1C06070			
70	N1C07070			

H  
L  
P

Misure in cm  
Measures in cm  
Mesures en cm  
Maße in cm

**F1** Laccato opaco  
Matt lacquered  
Laqué mat  
Matt lackiert

**F2** Laccato lucido  
Glossy lacquered  
Laqué brillant  
Hochglanz lackiert

**F3** Nobilitati  
Veneer wood  
Placage bois  
Beschichtetes Holz

**F4** Arock®  
Arock®  
Arock®  
Arock®

**F5** abitat / vogue  
abitat / vogue  
abitat / vogue  
abitat / vogue

TUTTE LE COLONNE A GIORNO







## Colonne a giorno Tall shelving units

## Colonnes murales ouvertes Regalelemente

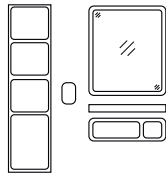

UNICAMENTE  
AROCK®

34

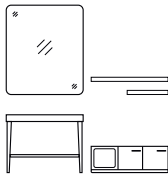

ALCENTIMETRO  
PROGETTO

98

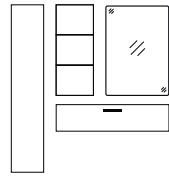

Elementi  
CONTENTORI

180

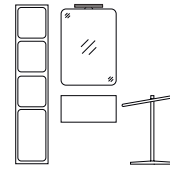

Elementi  
COMPLEMENTARI

226



RICAMBI

592

### H 100

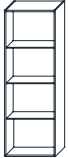

### P 18

Colonna a giorno • 4 vani  
Tall shelving unit • 4 compartments  
Colonne murale ouverte • 4 compartiments  
Regalelement • 4 Fächer

L	F1	F2	F3
30	N5C03012		
35	N5C03512		
45	N5C04512		

### H 125

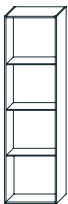

### P 18

Colonna a giorno • 4 vani  
Tall shelving unit • 4 compartments  
Colonne murale ouverte • 4 compartiments  
Regalelement • 4 Fächer

L	F1	F2	F3
30	N5C03022		
35	N5C03522		
45	N5C04522		

### H 140

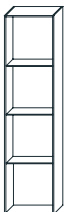

### P 18

Colonna a giorno • 4 vani  
Tall shelving unit • 4 compartments  
Colonne murale ouverte • 4 compartiments  
Regalelement • 4 Fächer

L	F1	F2	F3
30	N5C03016		
35	N5C03516		
45	N5C04516		



Misure in cm  
Measures in cm  
Mesures en cm  
Maße in cm

**F1** Laccato opaco  
Matt lacquered  
Laqué mat  
Matt lackiert

**F2** Laccato lucido  
Glossy lacquered  
Laqué brillant  
Hochglanz lackiert

**F3** Nobilitati  
Veneer wood  
Placage bois  
Beschichtetes Holz

**F4** Arock®  
Arock®  
Arock®  
Arock®

**F5** abitat / vogue  
abitat / vogue  
abitat / vogue  
abitat / vogue

## Colonne a giorno Tall shelving units

## Colonnes murales ouvertes Regalelemente

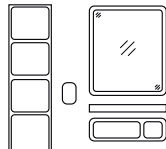

UNICAMENTE  
AROCK®

34

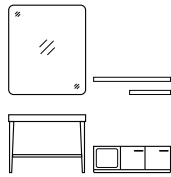

ALCENTIMETRO  
PROGETTO

98

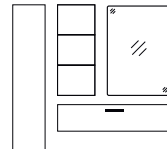

Elementi  
CONTENITORI

180

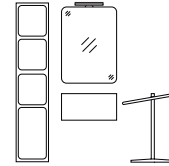

Elementi  
COMPLEMENTARI

226



RICAMBI

592

### H 175

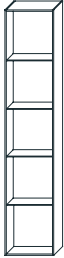

### P 18

Colonna a giorno • 5 vani  
Tall shelving unit • 5 compartments  
Colonne murale ouverte • 5 compartiments  
Regalelement • 5 Fächer

L	F1	F2	F3
30	N5C03024		
35	N5C03524		
45	N5C04524		



Misure in cm  
Measures in cm  
Mesures en cm  
Maße in cm

**F1** Laccato opaco  
Matt lacquered  
Laqué mat  
Matt lackiert

**F2** Laccato lucido  
Glossy lacquered  
Laqué brillant  
Hochglanz lackiert

**F3** Nobilitati  
Veneer wood  
Placage bois  
Beschichtetes Holz

**F4** Arock®  
Arock®  
Arock®  
Arock®

**F5** abitat / vogue  
abitat / vogue  
abitat / vogue  
abitat / vogue



## ELEMENTI

## COMPLEMENTARI

PER CREARE E COMPLETARE UN ARREDAMENTO

tutti i LAVABI	NON ALCENTIMETRO	PORTASALVIETTE	FREE-STANDING
tutti gli SPECCHI	NON ALCENTIMETRO	PORTASALVIETTE	A MURO
tutte le LAMPADE		MENSOLA	CON PORTASALVIETTE NON ALCENTIMETRO
		MENSOLA	NON ALCENTIMETRO
		COLONNINA	
VANO A GIORNO	ORIZZONTALE	POMOLO	PORTASALVIETTE IN AROCK®





. scegliere il lavabo nella seguente tabella **tipo di lavabo / serie di mobili**  
 . considerare la posizione del lavabo centrata alla mezzzeria del piano

. choose the basin in the following table **type of washbasin / series of furniture**  
 . consider the position of the basin centered on the center line of the top

. choisissez le lavabo dans le tableau suivant **type de lavabo / série de meubles**  
 . considérer la position du lavabo centrée au milieu du plan

. wählen Sie den Waschtisch in der folgenden **Tabelle Waschtischtyp / Möbelserie**  
 . die Position des Becken ist mittig auf der Oberseite der Möbelserie

● compatibile con miscelatore a parete, posteriore o laterale su piano  
 compatible with wall, back or side tap on the top  
 compatible avec le robinet mural, arrière ou lateral sur plan  
 kompatibel mit Wand, Rück oder Seitlichenhahn

■ compatibile con miscelatore a parete o laterale su piano  
 compatible with wall or side tap on the top  
 compatible avec le robinet mural ou lateral sur plan  
 kompatibel mit Wand oder Seitlichenhahn

▲ compatibile con miscelatore a parete  
 compatible with wall tap  
 compatible avec le robinet mural  
 kompatibel mit Wandhahn

✓ miscelatore installato sul lavabo  
 tap installed on the basin  
 robinet installé sur le lavabo  
 Wasserhahn auf den Becken installiert

				L	P	H	SHAMBOLA® CONSOLE PER LAVABO		SHAMBOLA® CONSOLE PER LAVABO CON TAVOLO		TALETE P 54	HAIKU®	LEALE	GIUSTO		
							P 45	P 51,5	P 45	P 51,5						
Lavabo soprapiano da appoggio Countertop basin Lavabo à poser Aufsetzbecken	CERAMICA CERAMIC CÉRAMIQUE KERAMIK	SOFTLY	OMLAPP01	59	42	16,5	●	●	●	●	●	●	●	●	●	
		NICE 50	OMLAPP02	50	40	18	■	●	■	●	●	■	●	■	●	
		NICE 65	OMLAPP03	65	40	20	■	●	■	●	●	■	●	■	●	
		IOS 50	OMLAPP06	50	38	12,5	▲	●	▲	●	●	▲	●	▲	●	
		POISON	OMLAPP08	73	43	17	■	●	■	●	●	■	●	■	●	
		CIRCLE	OMLAPP09	45	45	17	■	●	■	●	●	■	●	■	●	
		BULTAR	OMLAPP12	59,5	36,5	15	●	●	●	●	●	●	●	●	●	●
		CALEB 55	OMLAPP13	55	35	14,5	●	●	●	●	●	●	●	●	●	●
		CALEB 68	OMLAPP14	68	35	15	●	●	●	●	●	●	●	●	●	●
		ZETT	OMLAPP15	49	34	13	●	●	●	●	●	●	●	●	●	●
	WINDU	OMLAPP16	60	43	17	✓	✓	✓	✓	✓	✓	✓	✓	✓	✓	
	AROCK®	RUBIZIO	GGKL6002	60	38	14	●	●	●	●	●	●	●	●	●	●
		GNIFFO	GGKL4202	42	38	14	●	●	●	●	●	●	●	●	●	●
	Lavabo soprapiano da incasso Recessed basin Lavabo encastré surélevé Halbeinbaubecken	CERAMICA CERAMIC CÉRAMIQUE KERAMIK	SOFTLY H4	OMLINC01	59	42	17					●			■	
		AROCK®	ENCATRO	GGKL5010	50	35,5	16,2		●		●		●		●	
	Lavabo sottopiano da incasso Undermounted basin Lavabo en profondeur Untereinbaubecken	CERAMICA CERAMIC CÉRAMIQUE KERAMIK	DIANA	OMLSOT01	50,7	36,5	16						■		■	
IBRA 50			OMLSOT02	50,5	29	12					▲	●	▲	●	▲	●
AROCK®		ZONFO	GGKL4201	60	27,3	13						●	●	●	●	●
		FRIBBIO	GGKL6001	42	27,3	13						●	●	●	●	●



**SOFTLY**

Lavabo sopra piano da appoggio in ceramica bianca  
 White ceramic countertop basin  
 Lavabo à poser en céramique blanche  
 Aufsatzbecken aus weißer Keramik

**SOFTLY H4**

Lavabo sopra piano da incasso in ceramica bianca  
 White ceramic recessed basin  
 Lavabo encastré surélevé en céramique blanche  
 Halbeinbaubecken aus weißer Keramik

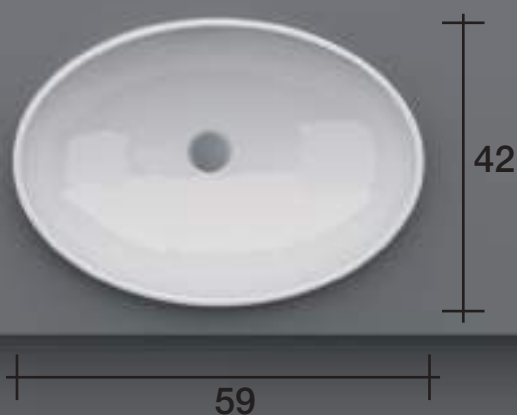
**OMLAPP01****OMLINC01**

non provvisto di scarico troppopieno  
 without overflow system  
 sans système de trop-plein  
 ohne Überlaufsystem

non provvisto di scarico troppopieno  
 without overflow system  
 sans système de trop-plein  
 ohne Überlaufsystem

kit piletta e sifone da ordinare separatamente  
 waste kit and siphon to be ordered separately  
 kit bonde d'évacuation et siphon à commander séparément  
 Ablauf Kit und Siphon müssen separat bestellt werden

kit piletta e sifone da ordinare separatamente  
 waste kit and siphon to be ordered separately  
 kit bonde d'évacuation et siphon à commander séparément  
 Ablauf Kit und Siphon müssen separat bestellt werden

**Parte tecnica**  
**Technical section**

**SOFTLY**



per l'installazione è obbligatorio l'uso del sifone salvaspazio

space saving siphon required  
siphon peu encombrant requis  
platzsparender Siphon erforderlich

su basi portalavabo min L 60 cm  
washbasin unit min W 60 cm  
meuble sous-vasque min L 60 cm  
Waschtischunterschrank min B 60 cm

piano sospeso min L 60 cm  
wall counter top min W 60 cm  
plan suspendu pour l'ameublement min L 60 cm  
aufgehängte Platte fuer Einrichtung min B 60 cm

**Section technique**  
**Technischer Teil**

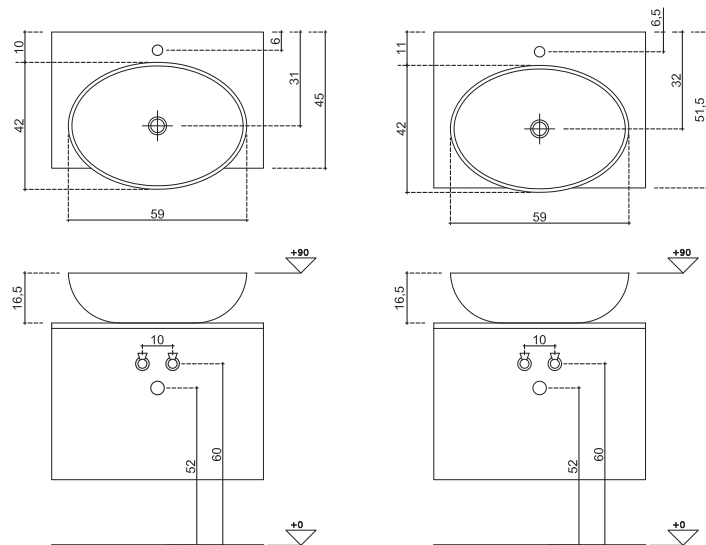

**SOFTLY H4**



su basi portalavabo min L 70 cm  
washbasin unit min W 70 cm  
meuble sous-vasque min L 70 cm  
Waschtischunterschrank min B 70

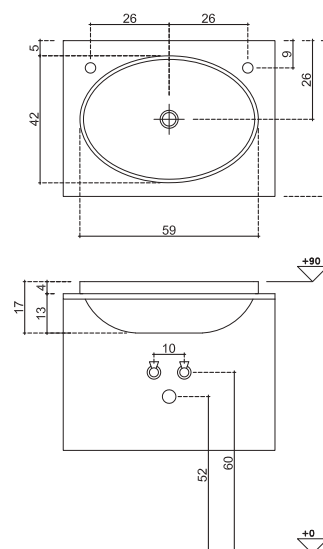

**NICE 65**

Lavabo sopra piano da appoggio in ceramica bianca  
 White ceramic countertop basin  
 Lavabo à poser en céramique blanche  
 Aufsatzbecken aus weißer Keramik

**NICE 50**

Lavabo sopra piano da appoggio in ceramica bianca  
 White ceramic countertop basin  
 Lavabo à poser en céramique blanche  
 Aufsatzbecken aus weißer Keramik

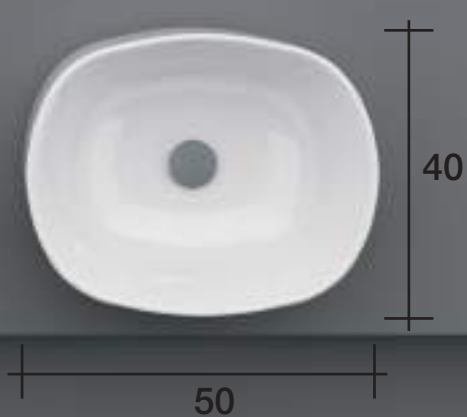
**OMLAPP03****OMLAPP02**

non provvisto di scarico troppopieno  
 without overflow system  
 sans système de trop-plein  
 ohne Überlaufsystem

kit piletta e sifone da ordinare separatamente  
 waste kit and siphon to be ordered separately  
 kit bonde d'évacuation et siphon à commander séparément  
 Ablauf Kit und Siphon müssen separat bestellt werden

non provvisto di scarico troppopieno  
 without overflow system  
 sans système de trop-plein  
 ohne Überlaufsystem

kit piletta e sifone da ordinare separatamente  
 waste kit and siphon to be ordered separately  
 kit bonde d'évacuation et siphon à commander séparément  
 Ablauf Kit und Siphon müssen separat bestellt werden



**CALEB 68**

Lavabo soprapiano da appoggio in ceramica bianca  
 White ceramic countertop basin  
 Lavabo à poser en céramique blanche  
 Aufsatzbecken aus weißer Keramik

**CALEB 55**

Lavabo soprapiano da appoggio in ceramica bianca  
 White ceramic countertop basin  
 Lavabo à poser en céramique blanche  
 Aufsatzbecken aus weißer Keramik

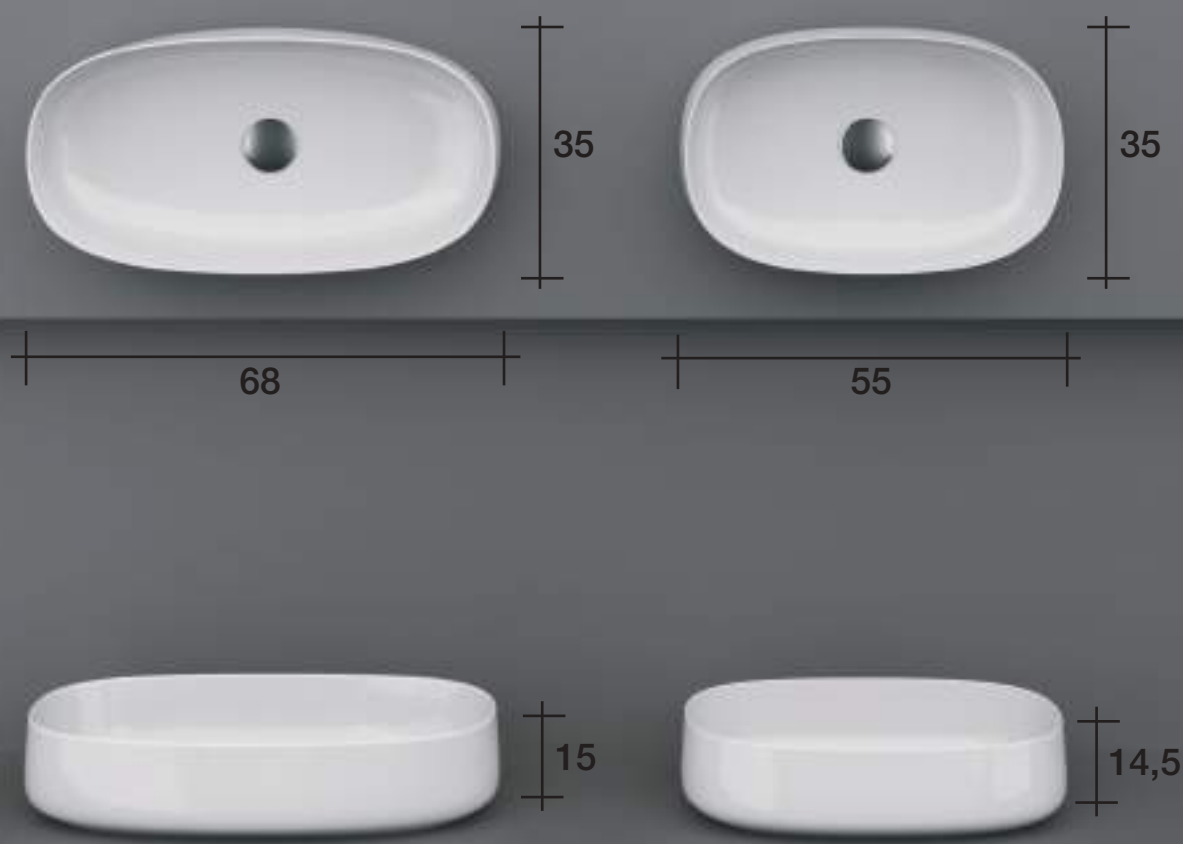
**OMLAPP14****OMLAPP13**

non provvisto di scarico troppopieno  
 without overflow system  
 sans système de trop-plein  
 ohne Überlaufsystem

kit piletta e sifone da ordinare separatamente  
 waste kit and siphon to be ordered separately  
 kit bonde d'évacuation et siphon à commander séparément  
 Ablauf Kit und Siphon müssen separat bestellt werden

non provvisto di scarico troppopieno  
 without overflow system  
 sans système de trop-plein  
 ohne Überlaufsystem

kit piletta e sifone da ordinare separatamente  
 waste kit and siphon to be ordered separately  
 kit bonde d'évacuation et siphon à commander séparément  
 Ablauf Kit und Siphon müssen separat bestellt werden

Parte tecnica  
Technical section

**CALEB 68**



su basi portalavabo min L 70 cm  
washbasin unit min W 70 cm  
meuble sous-vasque min L 70 cm  
Waschtischunterschrank min B 70

piano sospeso min L 70 cm  
wall counter top min W 70 cm  
plan suspendu pour l'ameublement min L 70 cm  
aufgehangte Platte fuer Einrichtung min B 70 cm

Section technique  
Technischer Teil

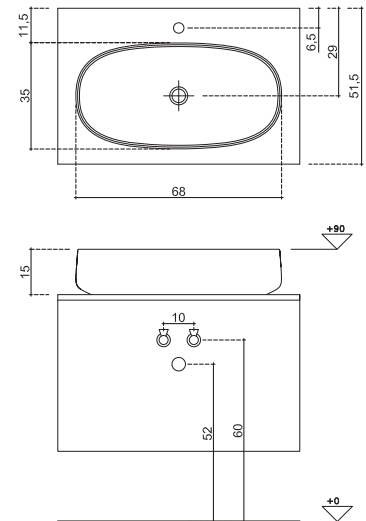
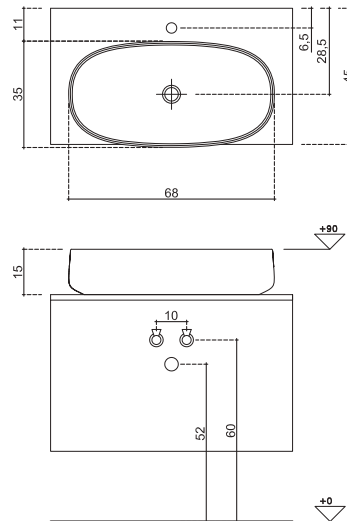

**CALEB 55**



su basi portalavabo min L 60 cm  
washbasin unit min W 60 cm  
meuble sous-vasque min L 60 cm  
Waschtischunterschrank min B 60 cm

piano sospeso min L 60 cm  
wall counter top min W 60 cm  
plan suspendu pour l'ameublement min L 60 cm  
aufgehangte Platte fuer Einrichtung min B 60 cm

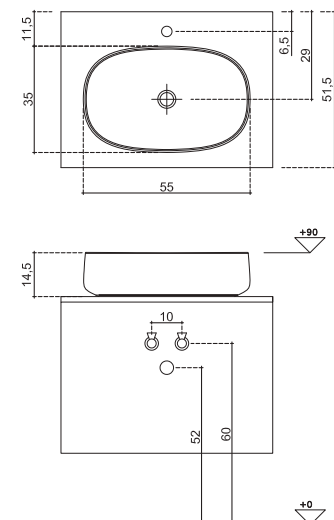
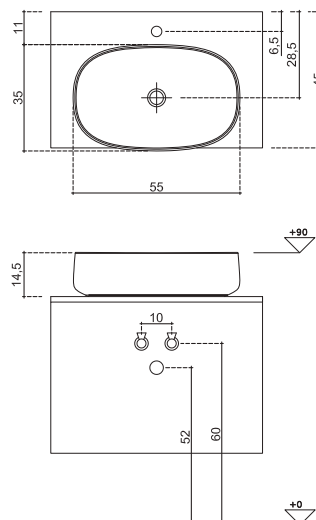

**POISON**

Lavabo sopra piano da appoggio in ceramica bianca  
 White ceramic countertop basin  
 Lavabo à poser en céramique blanche  
 Aufsatzbecken aus weißer Keramik

**CIRCLE**

Lavabo sopra piano da appoggio in ceramica bianca  
 White ceramic countertop basin  
 Lavabo à poser en céramique blanche  
 Aufsatzbecken aus weißer Keramik

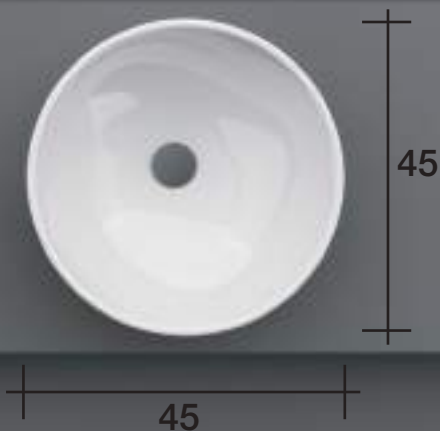
**OMLAPP08****OMLAPP09**

non provvisto di scarico troppopieno  
 without overflow system  
 sans système de trop-plein  
 ohne Überlaufsystem

kit piletta e sifone da ordinare separatamente  
 waste kit and siphon to be ordered separately  
 kit bonde d'évacuation et siphon à commander séparément  
 Ablauf Kit und Siphon müssen separat bestellt werden

non provvisto di scarico troppopieno  
 without overflow system  
 sans système de trop-plein  
 ohne Überlaufsystem

kit piletta e sifone da ordinare separatamente  
 waste kit and siphon to be ordered separately  
 kit bonde d'évacuation et siphon à commander séparément  
 Ablauf Kit und Siphon müssen separat bestellt werden



**Parte tecnica**  
**Technical section**

**POISON**



- . per installazione su P 51,5 cm è obbligatorio l'utilizzo del sifone salvaspazio
- . space saving siphon required on tops P 51,5
- . siphon peu encombrant requis pour plans P 51,5
- . platzsparender Siphon für P 51,5 Plan erforderlich

su basi portalavabo min L 72 cm  
washbasin unit min W 72 cm  
meuble sous-vasque min L 72 cm  
Waschtischunterschrank min B 72 cm

piano sospeso min L 73 cm  
wall counter top min W 73 cm  
plan suspendu pour l'ameublement min L 73 cm  
aufgehängte Platte fuer Einrichtung min B 73 cm

**Section technique**  
**Technischer Teil**

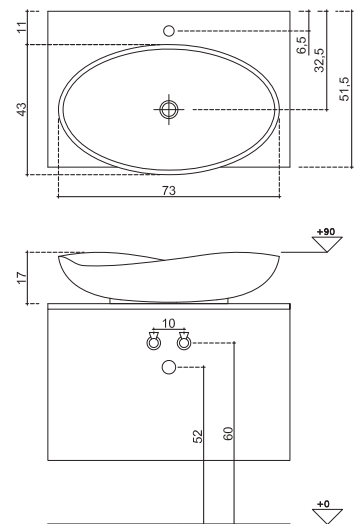
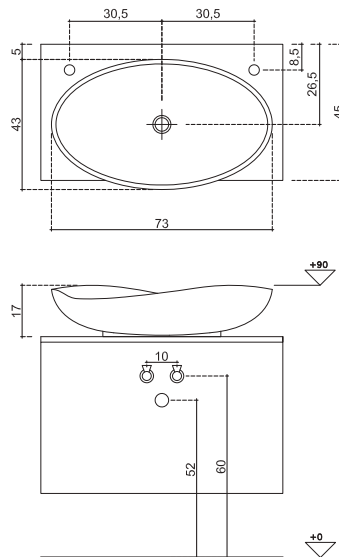

**CIRCLE**



- . per installazione su P 51,5 cm è obbligatorio l'utilizzo del sifone salvaspazio
- . space saving siphon required on tops P 51,5
- . siphon peu encombrant requis pour plans P 51,5
- . platzsparender Siphon für P 51,5 Plan erforderlich

su basi portalavabo min L 60 cm  
washbasin unit min W 60 cm  
meuble sous-vasque min L 60 cm  
Waschtischunterschrank min B 60 cm

piano sospeso min L 60 cm  
wall counter top min W 60 cm  
plan suspendu pour l'ameublement min L 60 cm  
aufgehängte Platte fuer Einrichtung min B 60 cm

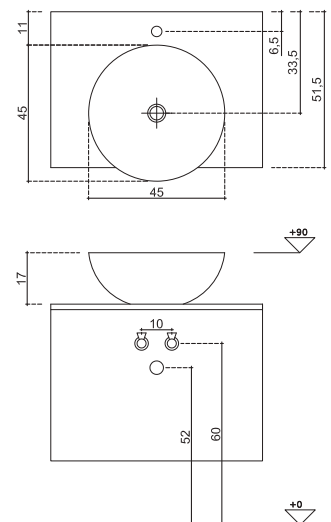
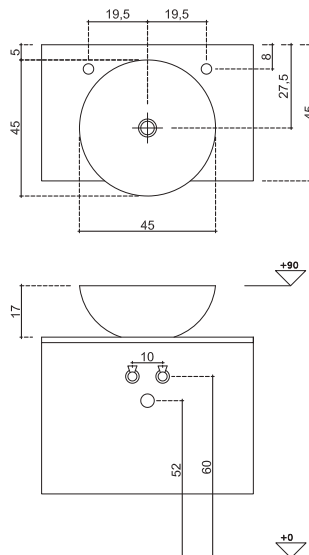

**WINDU**

Lavabo sopra piano da appoggio in ceramica bianca  
 White ceramic countertop basin  
 Lavabo à poser en céramique blanche  
 Aufsatzbecken aus weißer Keramik

**ZETT**

Lavabo sopra piano da appoggio in ceramica bianca  
 White ceramic countertop basin  
 Lavabo à poser en céramique blanche  
 Aufsatzbecken aus weißer Keramik

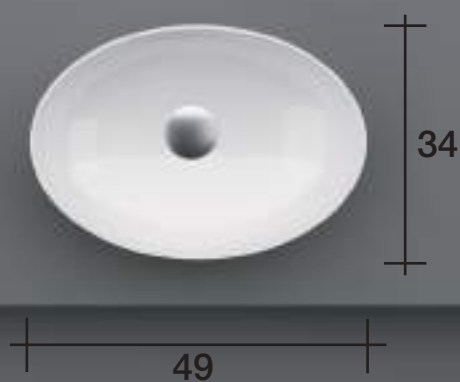
**OMLAPP16****OMLAPP15**

non provvisto di scarico troppopieno  
 without overflow system  
 sans système de trop-plein  
 ohne Überlaufsystem

kit piletta e sifone da ordinare separatamente  
 waste kit and siphon to be ordered separately  
 kit bonde d'évacuation et siphon à commander séparément  
 Ablauf Kit und Siphon müssen separat bestellt werden

non provvisto di scarico troppopieno  
 without overflow system  
 sans système de trop-plein  
 ohne Überlaufsystem

kit piletta e sifone da ordinare separatamente  
 waste kit and siphon to be ordered separately  
 kit bonde d'évacuation et siphon à commander séparément  
 Ablauf Kit und Siphon müssen separat bestellt werden

**Parte tecnica**  
**Technical section**

**WINDU**



su basi portalavabo min L 60 cm  
washbasin unit min W 60 cm  
meuble sous-vasque min L 60 cm  
Waschtischunterschrank min B 60

piano sospeso min L 60 cm  
wall counter top min W 60 cm  
plan suspendu pour l'ameublement min L 60 cm  
aufgehängte Platte fuer Einrichtung min B 60 cm

**Section technique**  
**Technischer Teil**

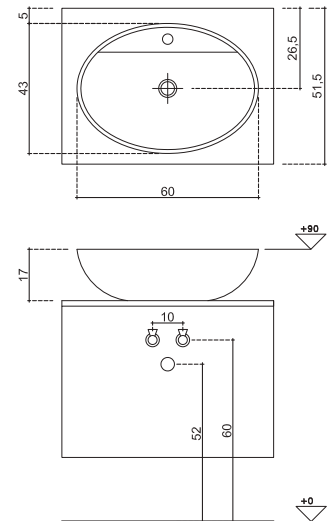
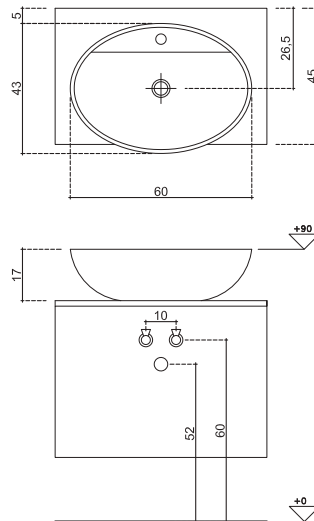

**ZETT**



su basi portalavabo min L 54 cm  
washbasin unit min W 54 cm  
meuble sous-vasque min L 54 cm  
Waschtischunterschrank min B 54

piano sospeso min L 54 cm  
wall counter top min W 54 cm  
plan suspendu pour l'ameublement min L 54 cm  
aufgehängte Platte fuer Einrichtung min B 54 cm

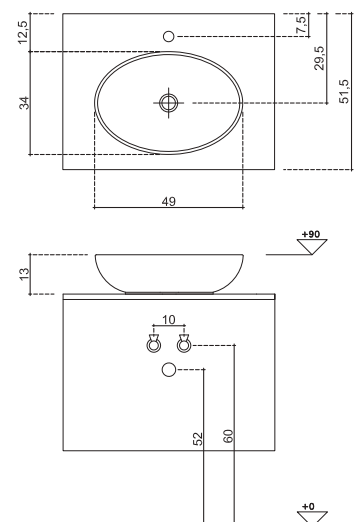
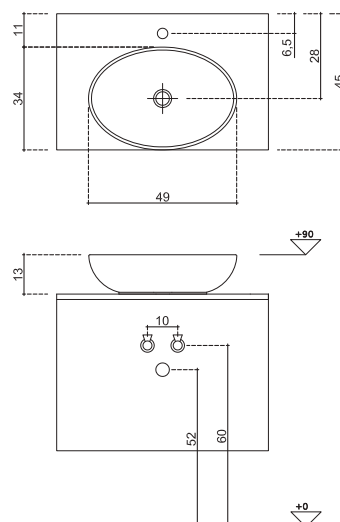

**BULTAR**

Lavabo soprapiano da appoggio in ceramica bianca  
 White ceramic countertop basin  
 Lavabo à poser en céramique blanche  
 Aufsatzbecken aus weißer Keramik

**IOS 50**

Lavabo soprapiano da appoggio in ceramica bianca  
 White ceramic countertop basin  
 Lavabo à poser en céramique blanche  
 Aufsatzbecken aus weißer Keramik

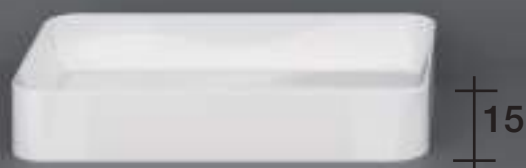
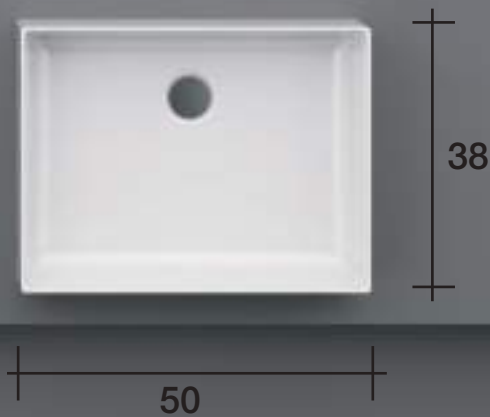
**OMLAPP12****OMLAPP06**

non provvisto di scarico troppopieno  
 without overflow system  
 sans système de trop-plein  
 ohne Überlaufsystem

kit piletta e sifone da ordinare separatamente  
 waste kit and siphon to be ordered separately  
 kit bonde d'évacuation et siphon à commander séparément  
 Ablauf Kit und Siphon müssen separat bestellt werden

non provvisto di scarico troppopieno  
 without overflow system  
 sans système de trop-plein  
 ohne Überlaufsystem

kit piletta e sifone da ordinare separatamente  
 waste kit and siphon to be ordered separately  
 kit bonde d'évacuation et siphon à commander séparément  
 Ablauf Kit und Siphon müssen separat bestellt werden

**Parte tecnica**  
**Technical section**

**BULTAR**



su basi portalavabo min L 60 cm  
washbasin unit min W 60 cm  
meuble sous-vasque min L 60 cm  
Waschtischunterschrank min B 60

piano sospeso min L 60 cm  
wall counter top min W 60 cm  
plan suspendu pour l'ameublement min L 60 cm  
aufgehängte Platte fuer Einrichtung min B 60 cm

**Section technique**  
**Technischer Teil**

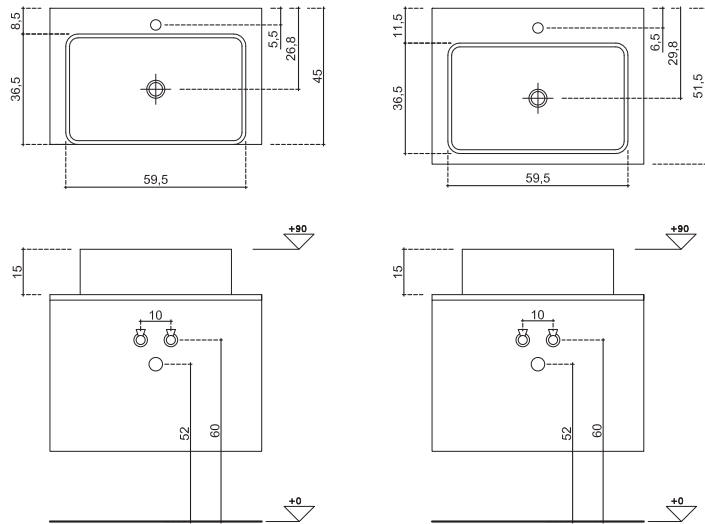

**IOS 50**



su basi portalavabo min L 54 cm  
washbasin unit min W 54 cm  
meuble sous-vasque min L 54 cm  
Waschtischunterschrank min B 54

piano sospeso min L 54 cm  
wall counter top min W 54 cm  
plan suspendu pour l'ameublement min L 54 cm  
aufgehängte Platte fuer Einrichtung min B 54 cm

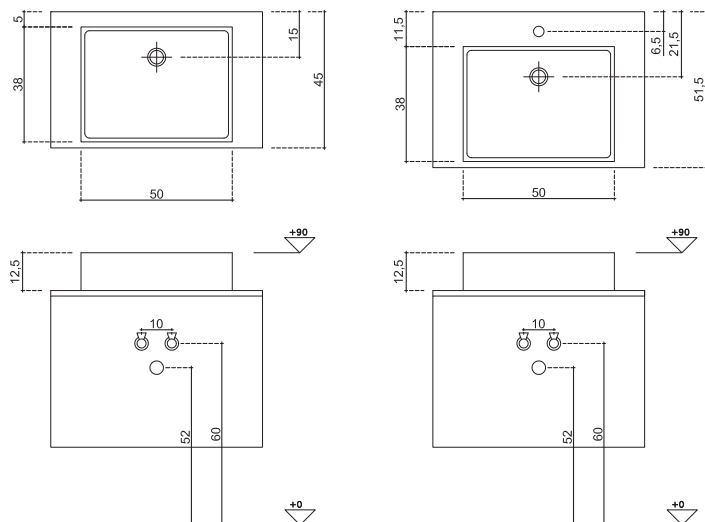

**RUBIZIO**

Lavabo sopra piano da appoggio in AROCK®  
 AROCK® countertop basin  
 Lavabo à poser en AROCK®  
 Aufsatzbecken aus AROCK®

**GNIFFO**

Lavabo sopra piano da appoggio in AROCK®  
 AROCK® countertop basin  
 Lavabo à poser en AROCK®  
 Aufsatzbecken aus AROCK®

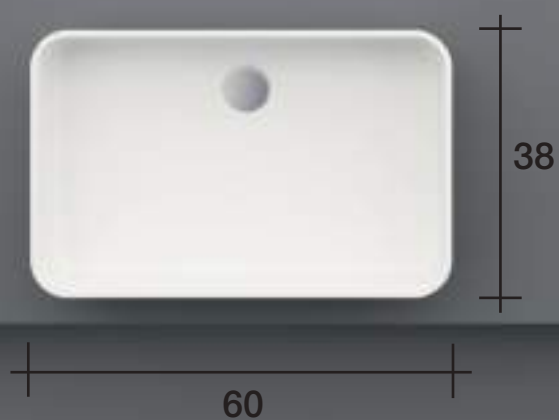
**GGKL6002****GGKL4202**

non provvisto di scarico troppopieno  
 without overflow system  
 sans système de trop-plein  
 ohne Überlaufsystem

kit piletta e sifone da ordinare separatamente  
 waste kit and siphon to be ordered separately  
 kit bonde d'évacuation et siphon à commander séparément  
 Ablauf Kit und Siphon müssen separat bestellt werden

non provvisto di scarico troppopieno  
 without overflow system  
 sans système de trop-plein  
 ohne Überlaufsystem

kit piletta e sifone da ordinare separatamente  
 waste kit and siphon to be ordered separately  
 kit bonde d'évacuation et siphon à commander séparément  
 Ablauf Kit und Siphon müssen separat bestellt werden

**Parte tecnica**  
**Technical section**

**RUBIZIO**



su basi portalavabo min L 60 cm  
washbasin unit min W 60 cm  
meuble sous-vasque min L 60 cm  
Waschtischunterschrank min B 20 cm

piano sospeso min L 60 cm  
wall counter top min W 60 cm  
plan suspendu pour l'ameublement min L 60 cm  
aufgehangte Platte fuer Einrichtung min B 60 cm

**Section technique**  
**Technischer Teil**

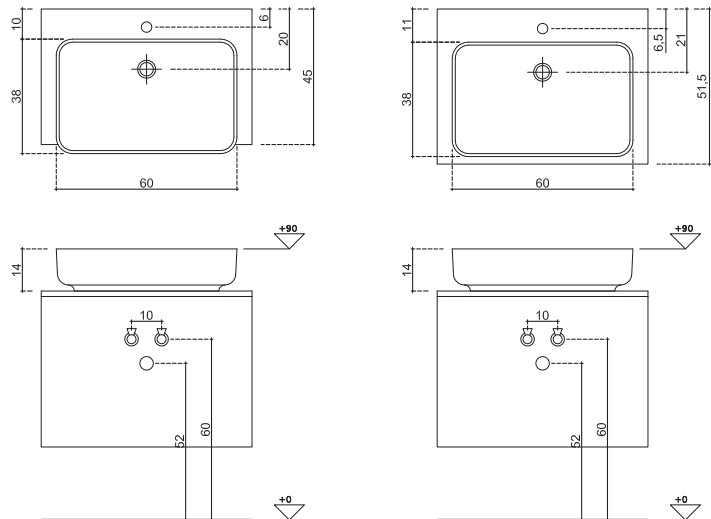

**GNIFFO**



su basi portalavabo min L 54 cm  
washbasin unit min W 54 cm  
meuble sous-vasque min L 54 cm  
Waschtischunterschrank min B 20 cm

piano sospeso min L 54 cm  
wall counter top min W 54 cm  
plan suspendu pour l'ameublement min L 54 cm  
aufgehangte Platte fuer Einrichtung min B 54 cm

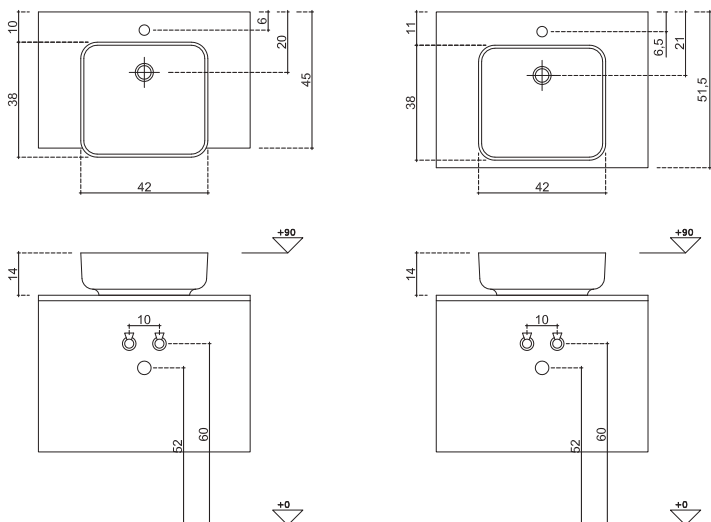



## ENCATRO

Lavabo soprapiano da incasso in AROCK®  
AROCK® recessed basin  
Lavabo encastré surélevé en AROCK®  
Halbeinbaubecken aus AROCK®

## GGKL5010



non provvisto di scarico troppopieno  
without overflow system  
sans système de trop-plein  
ohne Überlaufsystem

kit piletta e sifone da ordinare separatamente  
waste kit and siphon to be ordered separately  
kit bonde d'évacuation et siphon à commander séparément  
Ablauf Kit und Siphon müssen separat bestellt werden

**Parte tecnica**  
**Technical section**

**ENCATRO**



su basi portalavabo min L 54 cm  
washbasin unit min W 54 cm  
meuble sous-vasque min L 54 cm  
Waschtischunterschrank min B 54

piano sospeso min L 54 cm  
wall counter top min W 54 cm  
plan suspendu pour l'ameublement min L 54 cm  
aufgehängte Platte fuer Einrichtung min B 54 cm

**Section technique**  
**Technischer Teil**

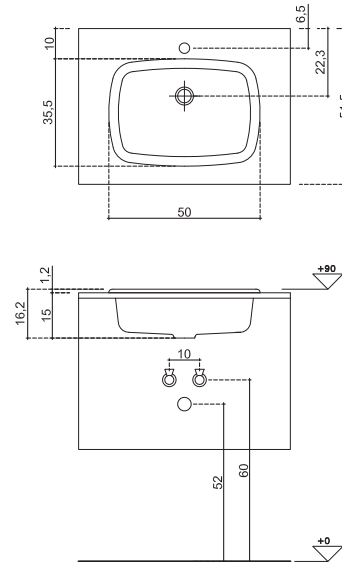

**IBRA**

Lavabo sottopiano da incasso in ceramica bianca  
 White ceramic undermounted basin  
 Lavabo en profondeur en céramique blanche  
 Unteneinbaubecken aus weißer Keramik

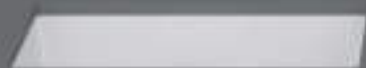
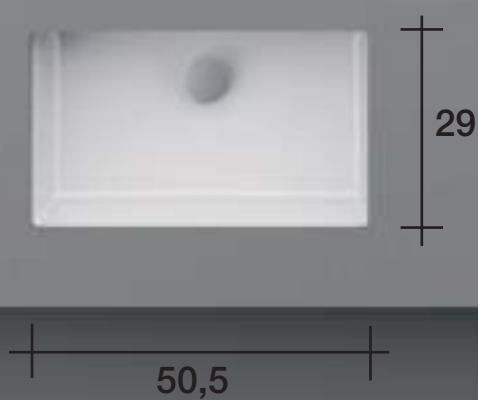
**OMLSOT02**

provvisto di scarico troppopieno  
 with overflow system  
 avec système de trop-plein  
 mit Überlaufsystem

kit piletta e sifone da ordinare separatamente  
 waste kit and siphon to be ordered separately  
 kit bonde d'évacuation et siphon à commander séparément  
 Ablauf Kit und Siphon müssen separat bestellt werden

**DIANA**

Lavabo sottopiano da incasso in ceramica bianca  
 White ceramic undermounted basin  
 Lavabo en profondeur en céramique blanche  
 Unteneinbaubecken aus weißer Keramik

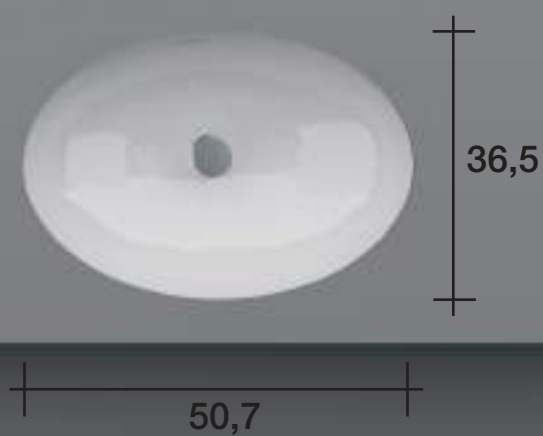
**OMLSOT01**

provvisto di scarico troppopieno  
 with overflow system  
 avec système de trop-plein  
 mit Überlaufsystem

kit piletta e sifone da ordinare separatamente  
 waste kit and siphon to be ordered separately  
 kit bonde d'évacuation et siphon à commander séparément  
 Ablauf Kit und Siphon müssen separat bestellt werden

Parte tecnica  
Technical section

**IBRA**



su basi portalavabo min L70 cm  
washbasin unit min W 70 cm  
meuble sous-vasque min L 70 cm  
Waschtischunterschrank min B 70 cm

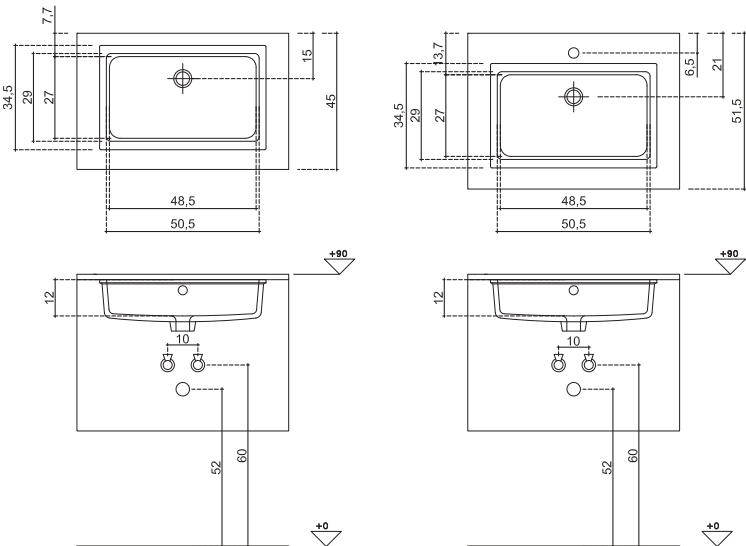

**DIANA**



su basi portalavabo min L70 cm  
washbasin unit min W 70 cm  
meuble sous-vasque min L 70 cm  
Waschtischunterschrank min B 70 cm

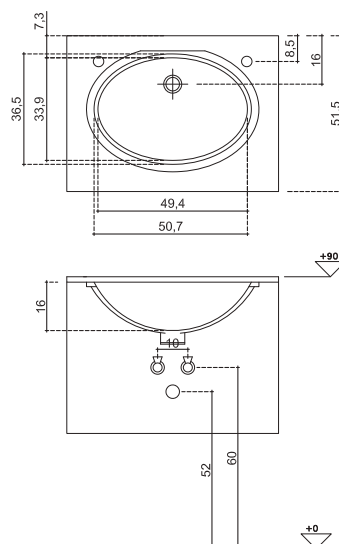

**FRIBBIO**

Lavabo sottopiano da incasso in AROCK®  
 AROCK® undermounted basin  
 Lavabo en profondeur en AROCK®  
 Unteneinbaubecken aus AROCK®

**ZONFO**

Lavabo sottopiano da incasso in AROCK®  
 AROCK® undermounted basin  
 Lavabo en profondeur en AROCK®  
 Unteneinbaubecken aus AROCK®

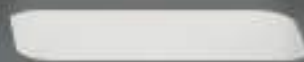
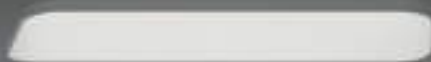
**GGKL6001****GGKL4201**

non provvisto di scarico troppopieno  
 without overflow system  
 sans système de trop-plein  
 ohne Überlaufsystem

kit piletta e sifone da ordinare separatamente  
 waste kit and siphon to be ordered separately  
 kit bonde d'évacuation et siphon à commander séparément  
 Ablauf Kit und Siphon müssen separat bestellt werden

non provvisto di scarico troppopieno  
 without overflow system  
 sans système de trop-plein  
 ohne Überlaufsystem

kit piletta e sifone da ordinare separatamente  
 waste kit and siphon to be ordered separately  
 kit bonde d'évacuation et siphon à commander séparément  
 Ablauf Kit und Siphon müssen separat bestellt werden

Parte tecnica  
Technical section

## FRIBBIO



su basi portalavabo min L 80 cm  
washbasin unit min W 80 cm  
meuble sous-vasque min L 80 cm  
Waschtischunterschrank min B 80 cm

Section technique  
Technischer Teil

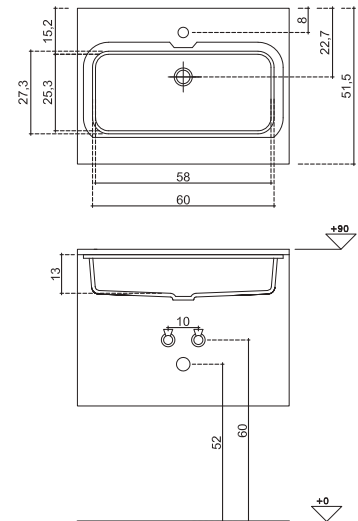
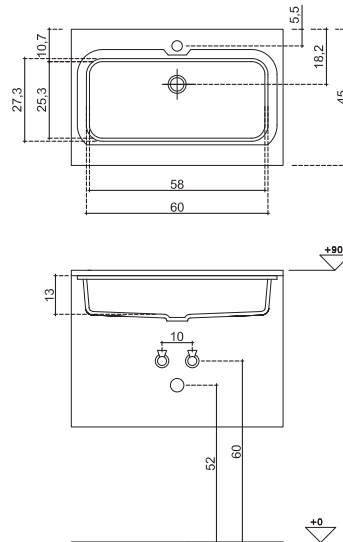

## ZONFO



su basi portalavabo min L 60 cm  
washbasin unit min W 60 cm  
meuble sous-vasque min L 60 cm  
Waschtischunterschrank min B 60 cm

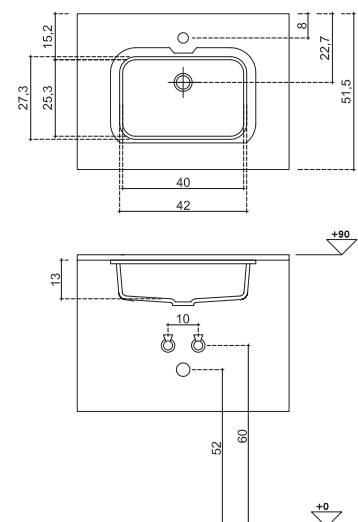
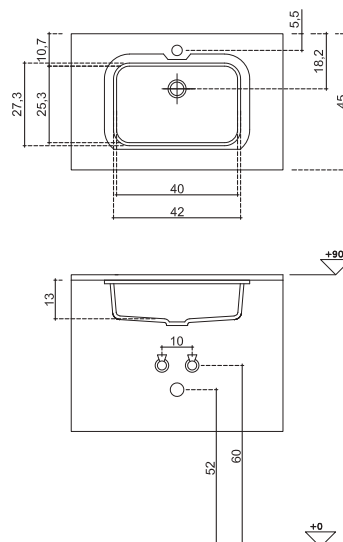



TUTTI GLI SPECCHI



# Specchi Mirrors

# Miroirs Spiegel

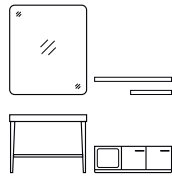

ALCENTIMETRO  
PROGETTO

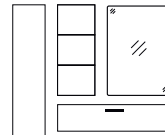

Elementi  
CONTENITORI

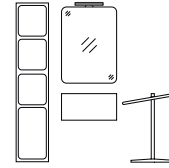

Elementi  
COMPLEMENTARI



RICAMBI

98

180

226

592

## H 75

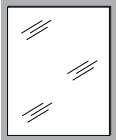

Specchio • illuminazione LED integrata perimetrale  
Backlit mirror • LED lighting  
Miroir • éclairage indirect par LED  
Spiegel • indirekt LED Beleuchtung

L			
60	N5R06075		
70	N5R07075		
90	N5R09075		
105	N5R10575		
120	N5R12075		

## H 90

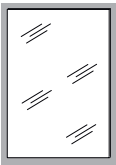

Specchio • illuminazione LED integrata perimetrale  
Backlit mirror • LED lighting  
Miroir • éclairage indirect par LED  
Spiegel • indirekt LED Beleuchtung

L			
60	N5R06090		
70	N5R07090		
90	N5R09090		
105	N5R10590		
120	N5R12090		

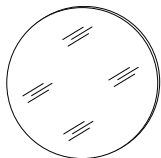

Specchio tondo  
Round mirror  
Miroir rond  
Runde Spiegel

L			
60	N5S060T6		
90	N5S090T9		

H  
L  
P

Misure in cm  
Measures in cm  
Mesures en cm  
Maße in cm

**F1** Laccato opaco  
Matt lacquered  
Laqué mat  
Matt lackiert

**F2** Laccato lucido  
Glossy lacquered  
Laqué brillant  
Hochglanz lackiert

**F3** Nobilitati  
Veneer wood  
Placage bois  
Beschichtetes Holz

**F4** Arock®  
Arock®  
Arock®  
Arock®

**F5** abitat / vogue  
abitat / vogue  
abitat / vogue  
abitat / vogue

# Specchi Mirrors

# Miroirs Spiegel

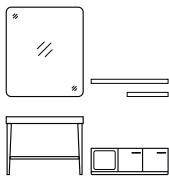

ALCENTIMETRO  
PROGETTO

98



Elementi  
CONTENTORI

180

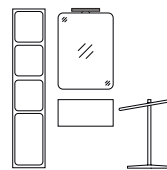

Elementi  
COMPLEMENTARI

226



RICAMBI

592



Specchio tondo • illuminazione LED integrata perimetrale  
Round backlit mirror • LED lighting  
Miroir rond rétro-éclairé • LED éclairage  
Runde Spiegel • indirekt LED Beleuchtung

**L**

60 N5R060T6

90 N5R090T9

**H 36****P 6**

Specchio • cornice Arock®  
Mirror • frame Arock®  
Miroir • cadre Arock®  
Spiegel • Rahmen Arock®

**L**

108 GGKSP022

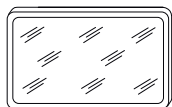
**F4****H 54****P 6**

Specchio • cornice Arock®  
Mirror • frame Arock®  
Miroir • cadre Arock®  
Spiegel • Rahmen Arock®

**L**

54 GGKSP012

90 GGKSP014

108 GGKSP015

**F4**

Misure in cm  
Measures in cm  
Mesures en cm  
Maße in cm

**F1**

Laccato opaco  
Matt lacquered  
Laqué mat  
Matt lackiert

**F2**

Laccato lucido  
Glossy lacquered  
Laqué brillant  
Hochglanz lackiert

**F3**

Nobilitati  
Veneer wood  
Placage bois  
Beschichtetes Holz

**F4**

Arock®  
Arock®  
Arock®

**F5**

abitat / vogue  
abitat / vogue  
abitat / vogue  
abitat / vogue

# Specchi Mirrors

# Miroirs Spiegel

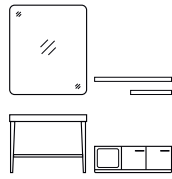

ALCENTIMETRO  
PROGETTO

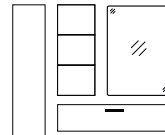

Elementi  
CONTENITORI

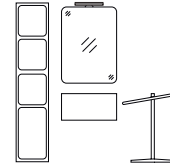

Elementi  
COMPLEMENTARI



RICAMBI

98

180

226

592

## H 90

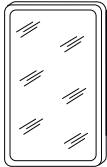

## P 6

Specchio • cornice Arock®  
Mirror • frame Arock®  
Miroir • cadre Arock®  
Spiegel • Rahmen Arock®

### L

54 GGKSP018

### F4

## H 108



## P 6

Specchio • cornice Arock®  
Mirror • frame Arock®  
Miroir • cadre Arock®  
Spiegel • Rahmen Arock®

### L

36 GGKSP020

54 GGKSP021

### F4

## H 54

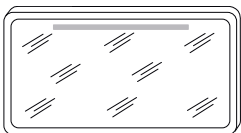

## P 12

Specchio • cornice Arock® + illuminazione LED integrata  
Mirror • frame Arock® + LED lighting  
Miroir • cadre Arock® + éclairage par LED  
Spiegel • Rahmen Arock® + LED Beleuchtung

### L

54 GGKSP002

90 GGKSP004

108 GGKSP005

### F4

H  
L  
P

Misure in cm  
Measures in cm  
Mesures en cm  
Maße in cm

**F1** Laccato opaco  
Matt lacquered  
Laqué mat  
Matt lackiert

**F2** Laccato lucido  
Glossy lacquered  
Laqué brillant  
Hochglanz lackiert

**F3** Nobilitati  
Veneer wood  
Placage bois  
Beschichtetes Holz

**F4** Arock®  
Arock®  
Arock®  
Arock®

**F5** abitat / vogue  
abitat / vogue  
abitat / vogue  
abitat / vogue

# Specchi Mirrors

# Miroirs Spiegel

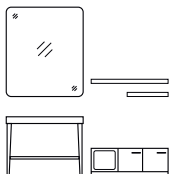

ALCENTIMETRO  
PROGETTO



Elementi  
CONTENITORI

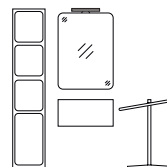

Elementi  
COMPLEMENTARI



RICAMBI

98

180

226

592

## H 90

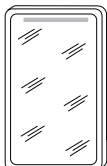

## P 6

Specchio • cornice Arock® + illuminazione LED integrata  
Mirror • frame Arock® + LED lighting  
Miroir • cadre Arock® + éclairage par LED  
Spiegel • Rahmen Arock® + LED Beleuchtung

## L

## F4

54 GGKSP008

## H 108

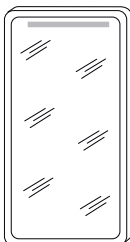

## P 6

Specchio • cornice Arock® + illuminazione LED integrata  
Mirror • frame Arock® + LED lighting  
Miroir • cadre Arock® + éclairage par LED  
Spiegel • Rahmen Arock® + LED Beleuchtung

## L

## F4

54 GGKSP011

## H 75

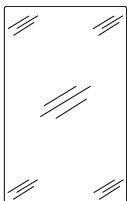

Specchio AERO  
Mirror AERO  
Miroir AERO  
Spiegel AERO

## L

60 N5S060A4

70 N5S070A4

80 N5S080A4

90 N5S090A4

100 N5S100A4

105 N5S105A4

110 N5S110A4

120 N5S120A4

140 N5S140A4



Misure in cm  
Measures in cm  
Mesures en cm  
Maße in cm

## F1

Laccato opaco  
Matt lacquered  
Laqué mat  
Matt lackiert

## F2

Laccato lucido  
Glossy lacquered  
Laqué brillant  
Hochglanz lackiert

## F3

Nobilitati  
Veneer wood  
Placage bois  
Beschichtetes Holz

## F4

Arock®  
Arock®  
Arock®

## F5

abitat / vogue  
abitat / vogue  
abitat / vogue  
abitat / vogue

# Specchi Mirrors

# Miroirs Spiegel

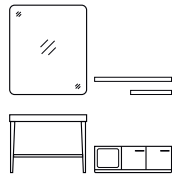

ALCENTIMETRO  
PROGETTO

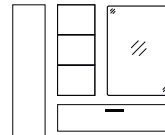

Elementi  
CONTENITORI

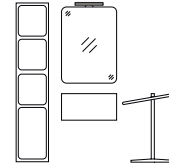

Elementi  
COMPLEMENTARI



RICAMBI

98

180

226

592

## H 90

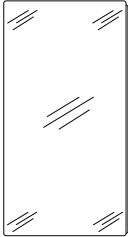

Specchio AERO  
Mirror AERO  
Miroir AERO  
Spiegel AERO

L			
60	N5S060A5		
70	N5S070A5		
80	N5S080A5		
90	N5S090A5		
100	N5S100A5		
105	N5S105A5		
110	N5S110A5		
120	N5S120A5		
140	N5S140A5		

## H 75

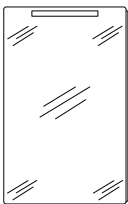

Specchio AERO • illuminazione LED frontale integrata  
Mirror AERO • ambient LED lighting  
Miroir AERO • éclairage par LED  
Spiegel AERO • integrierte LED Beleuchtung

L			
60	N5S060B4		
70	N5S070B4		
80	N5S080B4		
90	N5S090B4		
100	N5S100B4		
105	N5S105B4		
110	N5S110B4		
120	N5S120B4		
140	N5S140B4		

## H 110



Specchio LINEO  
Mirror LINEO  
Miroir LINEO  
Spiegel LINEO

L			
60	N5S060L6		
80	N5S080L6		
100	N5S100L6		
120	N5S120L6		

H  
L  
P

Misure in cm  
Measures in cm  
Mesures en cm  
Maße in cm

**F1** Laccato opaco  
Matt lacquered  
Laqué mat  
Matt lackiert

**F2** Laccato lucido  
Glossy lacquered  
Laqué brillant  
Hochglanz lackiert

**F3** Nobilitati  
Veneer wood  
Placage bois  
Beschichtetes Holz

**F4** Arock®  
Arock®  
Arock®  
Arock®

**F5** abitat / vogue  
abitat / vogue  
abitat / vogue  
abitat / vogue

TUTTE LE LAMPADE



## COLORE DELLA LUCE E CLASSE ENERGETICA COLOUR OF LIGHT AND ENERGY EFFICIENCY CLASS

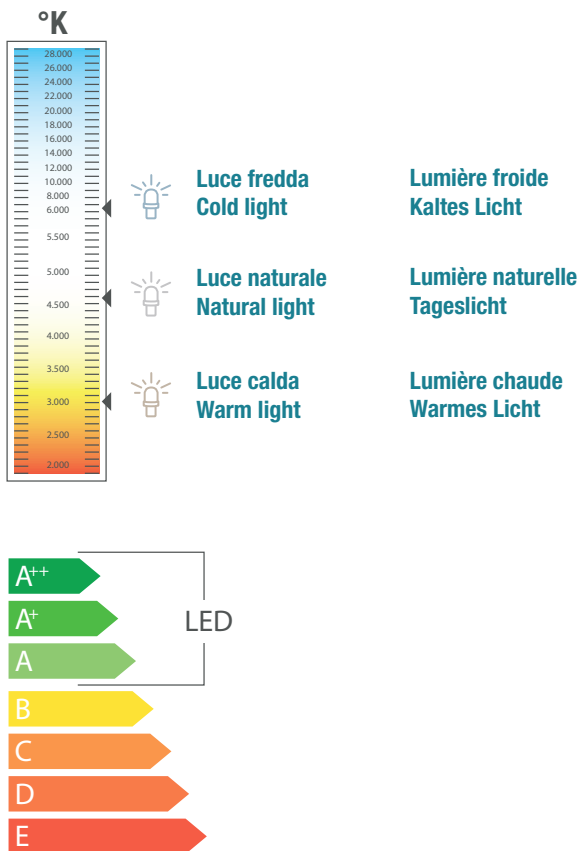

## COULEURS DE LA LUMIÈRE ET CLASSE ENERGETIQUE DIE FARBE DES LICHTES UND KLASSE-ENERGIEEFFIZIENZ

TDA ha introdotto nella sua gamma la tecnologia LED nel rispetto della normativa europea relativa alle lampade energivore. Attualmente è la sorgente luminosa con maggior resa e la più economica in termini di costi energetici. Tutti i dispositivi introdotti da TDA sono muniti di lampade LED integrate NON sostituibili.

TDA has introduced the LED technology in the observance of the european rules concerning high-energy lamps. Currently LED is the most performing low-cost light source ever. All devices introduced by TDA are supplied with integrated, non-replaceable lamps.

TDA a intégré dans la gamme de produit la technologie LED dans les respect des normes evropéennes des éclairages a haute consommation d'énergie. Actuellement c'est une source lumineuse a haute resolution et aussi la plus economique en terme de coût energetique.

TDA hat die LED Technologie in Übereinstimmung mit den europäischen Rechtsvorschriften über Energiesparlampen eingeführt. Derzeit ist LED die leistungsfähigste, billigste Lichtquelle. Alle von TDA eingeführten Geräte werden mit integrierten, nicht auswechselbaren Lichtquellen geliefert.

## GRADO DI PROTEZIONE IP IP PROTECTION GRADE

Il grado di protezione IP indica la resistenza offerta dall'apparecchio al passaggio di solidi e liquidi attraverso lo stesso. Le due cifre che seguono la sigla IP indicano rispettivamente: la prima il grado di protezione al passaggio di solidi e la seconda al passaggio di liquidi. IP44 indica la protezione contro corpi solidi di dimensioni superiori ad 1 mm, l'accesso con un filo e gli spruzzi d'acqua

The IP protection grade indicates the resistance of a device while liquids and solids pass through it. The first figure, following the IP acronym, indicates the protection level during the passage of solids while the second one marks the passage of liquids. IP44 indicates the protection against solid bodies of size greater than 1 mm, access with a wire and water spray

Le degré de protection IP indique la resistance donnée par l'appareil au passage de solides et liquides via le même. Les deux chiffres qui suivent le signe IP indiquent, la première le degré de protection au passage des solides, et la deuxième au passage des liquides. IP44 indique la protection contre les solides de dimension supérieure à 1 mm, l'accès avec un fil et les projections d'eau

Der IP-Schutzgrad gibt den Widerstand eines Geräts an, wenn es von festen und flüssigen Stoffen befahren wird. Die erste Ziffer nach der Kurzbezeichnung IP gibt den Schutzgrad gegen den Durchgang von Festkörpern an; die Zweite gibt den Schutzgrad gegen den Durchgang von Flüssigkeiten an. IP44 gibt den Schutz gegen Festkörper mit einem Maß über 1 mm an, Zugang mit einem Draht und Strahlwasser

## DEGRÉ DE PROTECTION IP SCHUTZGRAD IP





compatibile con specchio tondo e specchio retroilluminato  
it works well with round and backlit mirror  
ça marche bien avec miroir rond et avec éclairage indirect  
vereinbar mit runde Spiegel und indirekten Beleuchtung

**IP44**  
**Classe A / Class A / Classe A / Klass A**  
**6000K**



Luce fredda  
Cold light  
Lumière froide  
Kaltes Licht

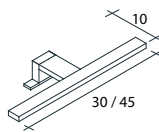
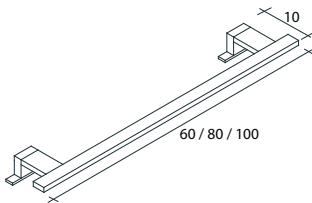

compatibile con specchio tondo e specchio retroilluminato  
it works well with round and backlit mirror  
ça marche bien avec miroir rond et avec éclairage indirect  
vereinbar mit runde Spiegel und indirekten Beleuchtung

**IP44**  
**Classe A / Class A / Classe A / Klass A**  
**4000K**



Luce calda  
Warm light  
Lumière chaude  
Warmes Licht

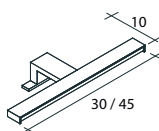
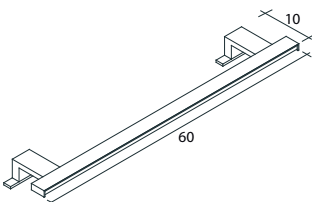

## DATA

Lampada LED orizzontale con diffusore lineare incassato e struttura cromata. Disponibile L 30/45 cm con piedino di fissaggio singolo e L 60/80/100 cm con doppio piedino di fissaggio da avvitare direttamente allo schienale tramite viti a scomparsa o tramite pinzatura  
Posizione di fissaggio: orizzontale sopra lo specchio

Horizontal LED lamp with recessed linear diffuser and chrome structure. Available W 30/45 cm with single fixing foot and W 60/80/100 cm with double fixing foot to be screwed to the rear panel of the mirror by means of clips or concealed screws. Fixing position: horizontal above the mirror

Lampe à LED horizontale avec diffuseur linéaire encastré et structure chromée. Disponible L 30/45 cm avec un pied de fixation et L 60/80/100 cm avec double pied de fixation à visser à l'arrière du miroir avec vis cachées ou pinces. Position de fixation: horizontale au-dessus du miroir

Horizontale LED-Lampe mit eingebautem, linearem Diffusor und Chromstruktur. Verfügbar B 30/45 cm mit einfachem Befestigungsfuß und B 60/80/100 cm mit doppeltem Befestigungsfuß. Verdeckter Schraubenbefestigung an der Rückplatte des Spiegels. Stellung: horizontal über dem Spiegel. mit doppeltem Steckfuß und Senkkopfschrauben erhältlich

cod.	L	finitura/finish/finition/Oberflächen
<b>OMFLED06</b>	<b>30</b>	<b>cromo</b>
<b>OMFLED08</b>	<b>45</b>	<b>cromo</b>
<b>OMFLED10</b>	<b>60</b>	<b>cromo</b>
<b>OMFLED12</b>	<b>80</b>	<b>cromo</b>
<b>OMFLED14</b>	<b>100</b>	<b>cromo</b>

## WORF

Lampada LED orizzontale con diffusore integrale e struttura cromata o nera. Disponibile L 30/45 cm con piedino di fissaggio singolo e L 60 cm con doppio piedino di fissaggio, avvitato direttamente nello schienale o tramite viti a scomparsa o tramite pinzatura.  
Posizione di fissaggio: orizzontale sopra lo specchio

Horizontal LED lamp with full diffuser and chrome or black structure. Available W 30/45 cm with single fixing foot and W 60 cm with double fixing foot to be screwed to the rear panel of the mirror by means of clips or concealed screws. Fixing position: horizontal above the mirror

Lampe LED horizontale avec diffuseur intégral et structure chromée ou noir. Disponible L 30/45 cm avec un pied de fixation et L 60 cm avec double pied de fixation à visser à l'arrière du miroir avec vis cachées ou pinces. Position de fixation: horizontale au-dessus du miroir

Horizontale LED-Lampe mit integralem Diffusor und Chromstruktur oder Schwarz. Verfügbar B 30/45 cm mit einfachem Befestigungsfuß und B 60 cm mit doppeltem Befestigungsfuß. Verdeckter Schraubenbefestigung an der Rückplatte des Spiegels. (oder durch Zangen). Stellung: horizontal über dem Spiegel

cod.	L	finitura/finish/finition/Oberflächen
<b>OMFLED16</b>	<b>30</b>	<b>cromo</b>
<b>OMFLED18</b>	<b>45</b>	<b>cromo</b>
<b>OMFLED20</b>	<b>60</b>	<b>cromo</b>
<b>OMFLED17</b>	<b>30</b>	<b>nero</b>
<b>OMFLED19</b>	<b>45</b>	<b>nero</b>
<b>OMFLED21</b>	<b>60</b>	<b>nero</b>



NON compatibile con specchio tondo e specchio retroilluminato  
it does not work with round and backlit mirror  
ça marche pas avec miroir rond et avec éclairage indirect  
nicht vereinbar mit runde Spiegel und indirekten Beleuchtung

**IP44**  
**Classe A / Class A / Classe A / Klass A**  
**6000K**



Luce fredda  
Cold light  
Lumière froide  
Kaltes Licht

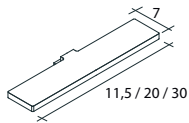

compatibile con specchio tondo e specchio retroilluminato  
it works well with round and backlit mirror  
ça marche bien avec miroir rond et avec éclairage indirect  
vereinbar mit runde Spiegel und indirekten Beleuchtung

**IP44**  
**Classe A / Class A / Classe A / Klass A**  
**6000K**



Luce fredda  
Cold light  
Lumière froide  
Kaltes Licht

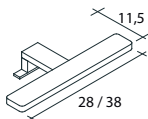

### KIRK

Lampada LED orizzontale con diffusore ad anello incassato e struttura cromata. Disponibile L 11,5/20/30 cm con piedino di fissaggio singolo avvitato direttamente nello schienale dello specchio tramite viti a scomparsa. Posizione di fissaggio: orizzontale sopra lo specchio

Horizontal LED lamp with recessed ring diffuser and chrome structure. Available W 11,5/20/30 cm with single fixing foot to be screwed to the rear panel of the mirror by means of concealed screws. Fixing position: horizontal above the mirror

Lampe à LED horizontale avec diffuseur encastré à anneaux et structure chromée. Disponible L 11,5/20/30 cm avec un pied de fixation à visser à l'arrière du miroir avec vis cachées. Position de fixation: horizontale au-dessus du miroir

Horizontale LED-Lampe mit eingebautem Ringdiffusor und Chromstruktur. Verfügbar B 11,5/20/30 cm mit einfachem Befestigungsfuß, der mit verdeckten Schrauben, an der Rückplatte des Spiegels angeschraubt werden kann. Stellung: horizontal über dem Spiegel

cod.	L	finitura/finish/finition/Oberflächen
<b>OMFLED22</b>	<b>11,5</b>	<b>cromo</b>
<b>OMFLED24</b>	<b>20</b>	<b>cromo</b>
<b>OMFLED26</b>	<b>30</b>	<b>cromo</b>

### SCOTT

Lampada LED orizzontale con diffusore lineare incassato e struttura cromata. Disponibile L 28 cm con piedino di fissaggio singolo avvitato direttamente allo schienale dello specchio tramite viti a scomparsa o tramite pinzatura. Posizione di fissaggio: orizzontale sopra lo specchio

Horizontal LED lamp with recessed linear diffuser and chrome structure. Available W 28 cm with single fixing foot to be screwed to the rear panel of the mirror by means of clips or concealed screws. Fixing position: horizontal above the mirror

Lampe à LED horizontale avec diffuseur linéaire encastré et structure chromée. Disponible L 28 cm avec un pied de fixation à visser à l'arrière du miroir avec vis cachées ou pinces. Position de fixation: horizontale au-dessus du miroir

Horizontale LED-Lampe mit eingebautem, linearem Diffusor und Chromstruktur. Verfügbar B 28 cm mit einfachem Befestigungsfuß, der mit verdeckten Schrauben, an der Rückplatte des Spiegels angeschraubt werden kann. Stellung: horizontal über dem Spiegel

cod.	L	finitura/finish/finition/Oberflächen
<b>OMFLED38</b>	<b>28</b>	<b>cromo</b>
<b>OMFLED39</b>	<b>38</b>	<b>cromo</b>



compatibile con specchio tondo e specchio retroilluminato  
it works well with round and backlit mirror  
ça marche bien avec miroir rond et avec éclairage indirect  
vereinbar mit runde Spiegel und indirekten Beleuchtung

**IP44**  
**Classe A / Class A / Classe A / Klass A**  
**6000K**



Luce fredda  
Cold light  
Lumière froide  
Kaltes Licht

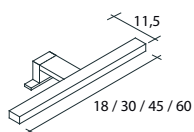

compatibile con specchio tondo e specchio retroilluminato  
it works well with round and backlit mirror  
ça marche bien avec miroir rond et avec éclairage indirect  
vereinbar mit runde Spiegel und indirekten Beleuchtung

**IP44**  
**Classe A / Class A / Classe A / Klass A**  
**4000K**



Luce calda  
Warm light  
Lumière chaude  
Warmes Licht

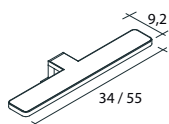

## LORE

Lampada LED orizzontale con diffusore lineare incassato e struttura cromata. Disponibile L 18/30/45/60 cm con piedino di fissaggio singolo avvitato direttamente allo schienale dello specchio tramite viti a scomparsa o tramite pinzatura. Posizione di fissaggio: orizzontale sopra lo specchio

Horizontal LED lamp with recessed linear diffuser and chrome structure. Available W 18/30/45/60 cm with single fixing foot to be screwed to the rear panel of the mirror by means of clips or concealed screws. Fixing position: horizontal above the mirror

Lampe à LED horizontale avec diffuseur linéaire encastré et structure chromée. Disponible L 18/30/45/60 cm avec un pied de fixation à visser à l'arrière du miroir avec vis cachées ou pinces. Position de fixation: horizontale au-dessus du miroir

Horizontale LED-Lampe mit eingebautem, linearem Diffusor und Chromstruktur. Verfügbar B 18/30/45/60 cm mit einfachem Befestigungsfuß an der Rückplatte des Spiegels mit verdeckten Schrauben. Steckfuß und Senkkopfschrauben erhältlich

cod.	L	finitura/finish/finition/Oberflächen
<b>OMFLED62</b>	<b>18</b>	<b>cromo</b>
<b>OMFLED64</b>	<b>30</b>	<b>cromo</b>
<b>OMFLED66</b>	<b>45</b>	<b>cromo</b>
<b>OMFLED68</b>	<b>60</b>	<b>cromo</b>

## AZAN

Lampada LED orizzontale con diffusore integrale in metacrilato e struttura cromata. Disponibile L 34/55 cm con piedino di fissaggio singolo avvitato direttamente allo schienale dello specchio tramite viti a scomparsa o tramite pinzatura. Posizione di fissaggio: orizzontale sopra lo specchio

Horizontal LED lamp with full diffuser and chrome structure. Available W 34/55 cm with single fixing to be screwed to the rear panel of the mirror by means of clips or concealed screws. Fixing position: horizontal above the mirror

Lampe LED horizontale avec diffuseur intégral et structure chromée. Disponible L 34/55 cm avec un pied de fixation à visser à l'arrière du miroir avec vis cachées ou pinces. Position de fixation: horizontale au-dessus du miroir

Horizontale LED-Lampe mit integralem Diffusor und Chromstruktur. Verfügbar B 30/45 cm mit einfachem Befestigungsfuß an der Rückplatte des Spiegels mit verdeckten Schrauben. Stellung: horizontal über dem Spiegel

cod.	L	finitura/finish/finition/Oberflächen
<b>OMFLED90</b>	<b>34</b>	<b>cromo</b>
<b>OMFLED92</b>	<b>55</b>	<b>cromo</b>



compatibile con specchio tondo e specchio retroilluminato  
it works well with round and backlit mirror  
ça marche bien avec miroir rond et avec éclairage indirect  
vereinbar mit runde Spiegel und indirekten Beleuchtung

**IP44**  
**Classe A / Class A / Classe A / Klass A**  
**4000K**



Luce calda  
Warm light  
Lumière chaude  
Warmes Licht



compatibile con specchio tondo e specchio retroilluminato  
it works well with round and backlit mirror  
ça marche bien avec miroir rond et avec éclairage indirect  
vereinbar mit runde Spiegel und indirekten Beleuchtung

**IP44**  
**Classe A / Class A / Classe A / Klass A**  
**4000K**



Luce calda  
Warm light  
Lumière chaude  
Warmes Licht

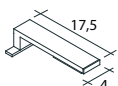

### UHURA

Lampada LED orizzontale con corpo cromato e sezione luminosa di forma cubica. Disponibile L 5x12 cm con piedino di fissaggio singolo avvitato direttamente nello schienale dello specchio tramite viti a scomparsa o tramite pinzatura. Posizione di fissaggio: orizzontale sopra lo specchio

Horizontal LED lamp with chrome structure and cubic light diffuser. Available W 5x12 cm with single fixing foot screwed to the rear panel of the mirror by means of clips or concealed screws ou pincers.

Fixing position: horizontal above the mirror

Lampe à LED horizontale avec structure chromée de forme cubique. Disponible L 5x12 cm avec un pied de fixation à visser à l'arrière du miroir avec vis cachées. Position de fixation: horizontale au-dessus du miroir

Horizontale LED-Lampe mit Chromstruktur und würfelförmigem Licht. Verfügbar B 5x12 cm mit einfachem Befestigungsfuß, der mit verdeckten Schrauben, an der Rückplatte des Spiegels angeschraubt werden kann. Stellung: horizontal über dem Spiegel

cod.	L	finitura/finish/finition/Oberflächen
<b>OMFLED88</b>	<b>5</b>	<b>cromo</b>

### SELA

Lampada LED orizzontale con diffusore a doppio led e struttura cromata. Disponibile L 4 x 17,5 cm con piedino di fissaggio singolo avvitato direttamente nello schienale tramite viti a scomparsa o tramite pinzatura. Posizione di fissaggio: orizzontale sopra lo specchio

Horizontal LED lamp with double light diffuser and chrome structure. Available W 4 x 17,5 cm with single fixing foot screwed to the rear panel of the mirror by means of clips or concealed screws.

Fixing position: horizontal above the mirror

Lampe à LED horizontale avec double diffuseur et structure chromée. Disponible L 4 x 17,5 cm avec un pied de fixation à visser à l'arrière du miroir avec vis cachées ou pincers.

Position de fixation: horizontale au-dessus du miroir

Horizontale LED-Lampe mit doppeltem Diffusor und Chromstruktur. Verfügbar B 4 x 17,5 cm mit einfachem Befestigungsfuß, der mit verdeckten Schrauben, an der Rückplatte des Spiegels angeschraubt werden kann. Befestigungsposition: horizontal über dem Spiegel

cod.	L	finitura/finish/finition/Oberflächen
<b>OMFLED86</b>	<b>4</b>	<b>cromo</b>



**IP20**  
**Classe A+ / Class A+**  
**Classe A+ / Klass A+**  
**4000K**



Luce calda  
 Warm light  
 Lumière chaude  
 Warmes Licht



NON compatibile con specchio tondo e specchio retroilluminato  
 it does not work with round and backlit mirror  
 ça marche pas avec miroir rond et avec éclairage indirect  
 nicht vereinbar mit runde Spiegel und indirekten Beleuchtung



**IP44**  
**Classe A / Class A**  
**Classe A / Klass A**  
**6000K**



Luce fredda  
 Cold light  
 Lumière froide  
 Kaltes Licht

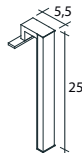

compatibile con specchio tondo e specchio retroilluminato  
 it works well with round and backlit mirror  
 ça marche bien avec miroir rond et avec éclairage indirect  
 vereinbar mit runde Spiegel und indirekten Beleuchtung

### PICARD

Lampada LED verticale con diffusore integrale in metacrilato e base cromata. Disponibile in H 30 cm. Fissaggio direttamente nello schienale dello specchio tramite viti a scomparsa.

Posizione di fissaggio: verticale adesa allo specchio

Vertical LED lamp with chrome methacrylate integral diffuser. Available H 30 cm. To be screwed to the rear panel of the mirror by means of concealed screws. Fixing position: vertical, adherent to the mirror

Lampe à LED verticale avec diffuseur intégral en en métacrylate chromé. Disponible H 30 cm avec fixation à visser à l'arrière du miroir avec vis cachées. Position de fixation: verticale adhérente au miroir

Senkrechte LED-Lampe mit integralem Diffusor aus verchromtem Methacrylat. Verfügbar H 30 cm mit einfachem Befestigungsfuß, der mit verdeckten Schrauben (oder durch Heften), an der Rückplatte des Spiegels angeschraubt werden kann.

Befestigungsposition: senkrecht gegen den Spiegel

cod.	H	finitura/finish/finition/Oberflächen
OMFLED02	30	cromo

### RIKER

Lampada LED verticale con diffusore incassato in metacrilato e base cromata. Disponibile in H 25 cm. Fissaggio direttamente nello schienale dello specchio tramite viti a scomparsa o tramite pinzatura sullo specchio.

Posizione di fissaggio: verticale sospesa allo specchio

Vertical LED lamp with recessed chrome methacrylate diffuser. Available H 25 cm. To be screwed to the rear panel of the mirror by means of clips or concealed screws.

Fixing position: vertical, suspended

Lampe à LED verticale avec diffuseur encastré en métacrylate chromé. Disponible H 25 cm avec fixation à visser à l'arrière du miroir avec vis cachées ou pinces.

Position de fixation: verticale, suspendue

Senkrechte LED-Lampe mit eingebautem Diffusor aus verchromtem Methacrylat. Verfügbar H 25 cm mit einfachem Befestigungsfuß, der mit verdeckten Schrauben (oder durch Zangen), an der Rückplatte des Spiegels angeschraubt werden kann.

Stellung: senkrecht, hängend

cod.	H	finitura/finish/finition/Oberflächen
OMFLED04	30	cromo



**IP20**  
**Classe A+ / Class A+**  
**Classe A+ / Class A+**  
**3000K**



Luce calda  
 Warm light  
 Lumière chaude  
 Warmes Licht

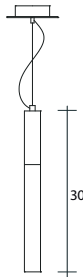

### SULU

Lampada LED a sospensione da soffitto con corpo cilindrico in vetro e cromato. Disponibile in H 30 cm. Fissaggio a soffitto tramite viti.  
 Posizione di fissaggio: sospesa sul piano

Suspended LED lamp with cylindrical glas and chrome body. Available H 30 cm. Ceiling fixation screws.  
 Fixing position: suspended

Lampe à LED suspendue avec structure cylindrique en vitrage et chromée. Disponible H 30. Fixation plafond au moyen de vis.  
 Position de fixation: suspendue sur le plan

Hängende LED-Lampe mit zylindrischem Hohlkörper aus Glas oder verchromt. Verfügbar H 30 cm. Dachbefestigung durch Schrauben.  
 Stellung: hängend

cod.	H	finitura/finish/finition/Oberflächen
<b>OMFLED36</b>	<b>30</b>	<b>cromo</b>



**IP44**  
**Classe A / Class A**  
**Classe A / Class A**  
**3000K**



Luce calda  
 Warm light  
 Lumière chaude  
 Warmes Licht

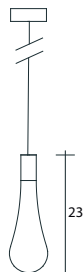

### YAR

Lampada LED a sospensione da soffitto con corpo in vetro e cromato o nero. Disponibile in H 23 cm. Fissaggio a soffitto tramite viti.  
 Posizione di fissaggio: sospesa sul piano

Suspended LED lamp with glas and chrome or black body. Available H 30 cm. Ceiling fixation screws.  
 Fixing position: suspended

Lampe à LED suspendue avec structure en vitrage et chromée ou noir. Disponible H 30. Fixation plafond au moyen de vis.  
 Position de fixation: suspendue sur le plan

Hängende LED-Lampe mit Hohlkörper aus Glas oder verchromt oder schwarz. Verfügbar H 30 cm. Dachbefestigung durch Schrauben.  
 Stellung: hängend

cod.	H	finitura/finish/finition/Oberflächen
<b>OMFLED94</b>	<b>23</b>	<b>cromo</b>
<b>OMFLED95</b>	<b>23</b>	<b>nero</b>

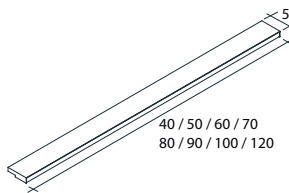
**IP44****Classe A / Class A / Classe A / Klass A  
4000K**Luce calda  
Warm lightLumière chaude  
Warmes Licht**KENOBI**

Lampada LED orizzontale con diffusore integrale in metacrilato e struttura cromata o nero. Disponibile L 40/50/60/70/80/90/100/120 cm con sistema di fissaggio da avvitare direttamente allo schienale.

Posizione di fissaggio: orizzontale sopra lo specchio

Horizontal LED lamp with recessed linear diffuser and chrome or black structure. Available W 40/50/60/70/80/90/100/120 cm to be screwed to the rear panel of the mirror by means of concealed screws.

Fixing position: horizontal above the mirror

Lampe à LED horizontale avec diffuseur linéaire encastré et structure chromée ou noir. Disponible L 40/50/60/70/80/90/100/120 cm avec fixation à visser à l'arrière du miroir avec vis cachées.

Position de fixation: horizontale au-dessus du miroir

Horizontale LED-Lampe mit eingebautem, linearem Diffusor und Chromstruktur oder schwarz. Verfügbar B 40/50/60/70/80/90/100/120 cm.

Verdeckter Schraubenbefestigung an der Rückplatte des Spiegels.

Stellung: horizontal über dem Spiegel

cod.	L	finitura/finish/finition/Oberflächen
OMFLED70	40	cromo
OMFLED72	50	cromo
OMFLED74	60	cromo
OMFLED75	60	nero
OMFLED76	70	cromo
OMFLED78	80	cromo
OMFLED79	80	nero
OMFLED80	90	cromo
OMFLED82	100	cromo
OMFLED84	120	cromo





VANI A GIORNO

SOLO ORIZZONTALI



VANO A GIORNO NOBILITATO / LACCATO



## Vano a giorno orizzontale Horizontal shelving unit

## Élément ouvert horizontal Offene Element-horizontal

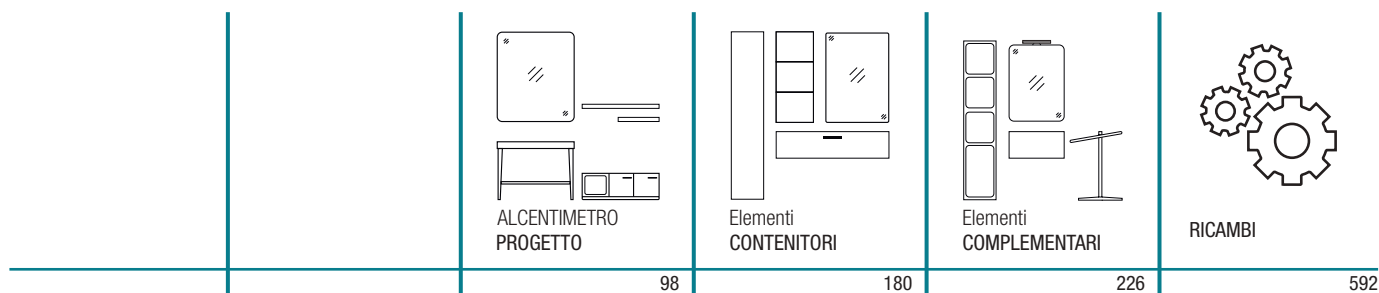
**H 25****P 18**

Vano a giorno orizzontale  
Horizontal shelving unit  
Élément ouvert horizontal  
Regalelement-horizontal

L	F1	F2	F3
30 N5Q03012			
35 N5Q03512			
45 N5Q04512			
60 N5Q06012			
70 N5Q07012			
90 N5Q09012			

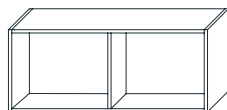
**H 25****P 18**

Vano a giorno orizzontale • 2 vani  
Horizontal shelving unit • 2 compartments  
Élément ouvert horizontal • 2 compartiments  
Regalelement-horizontal • 2 Fächer

L	F1	F2	F3
60 N5Q06014			
70 N5Q07014			

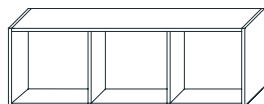
**H 25****P 18**

Vano a giorno orizzontale • 3 vani  
Horizontal shelving unit • 3 compartments  
Élément ouvert horizontal • 3 compartiments  
Regalelement-horizontal • 3 Fächer

L	F1	F2	F3
90 N5Q09014			



Misure in cm  
Measures in cm  
Mesures en cm  
Maße in cm

**F1** Laccato opaco  
Matt lacquered  
Laqué mat  
Matt lackiert

**F2** Laccato lucido  
Glossy lacquered  
Laqué brillant  
Hochglanz lackiert

**F3** Nobilitati  
Veneer wood  
Placage bois  
Beschichtetes Holz

**F4** Arock®  
Arock®  
Arock®  
Arock®

**F5** abitat / vogue  
abitat / vogue  
abitat / vogue  
abitat / vogue

## Vano a giorno orizzontale Horizontal shelving unit

## Élément ouvert horizontal Offene Element-horizontal

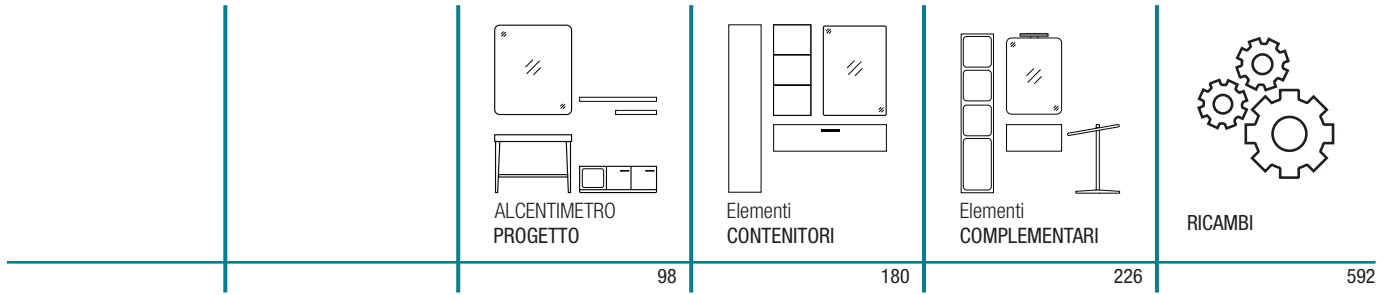

### H 25

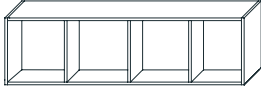

### P 18

Vano a giorno orizzontale • 4 vani  
Horizontal shelving unit • 4 compartments  
Élément ouvert horizontal • 4 compartiments  
Regalelement-horizontal • 4 Fächer

### L

105 N5Q10514

### F1

### F2

### F3

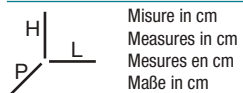

Misure in cm  
Measures in cm  
Mesures en cm  
Maße in cm

**F1** Laccato opaco  
Matt lacquered  
Laqué mat  
Matt lackiert

**F2** Laccato lucido  
Glossy lacquered  
Laqué brillant  
Hochglanz lackiert

**F3** Nobilitati  
Veneer wood  
Placage bois  
Beschichtetes Holz

**F4** Arock®  
Arock®  
Arock®  
Arock®

**F5** abitat / vogue  
abitat / vogue  
abitat / vogue  
abitat / vogue

PORTASALVIETTE FREE-STANDING AROCK®







. portasalviette free-standing con base in Arock® ottenuta da stampo disponibile in 48 colori.02  
 . struttura in alluminio anodizzato disponibile in finitura abitat e vogue o in 48 colori.02 laccato OPACO

. towel stand holder with molded Arock® base in 48 colori.02  
 . anodized aluminum structure available in abitat and vogue finishing or in 48 colori.02 MATT lacquered

. porte-serviettes autoportant avec base moulée Arock® en 48 colori.02  
 . structure en aluminium anodisé disponible en finition abitat et vogue ou en 48 colori.02 MAT laqué

. Handtuchhalter-stehend mit geformter Arock®-Basis in 48 colori.02  
 . eloxierte Aluminiumstruktur in abitat und vogue Ausführung erhältlich oder in 48 colori.02 MATT Lackiert

### abitat / vogue



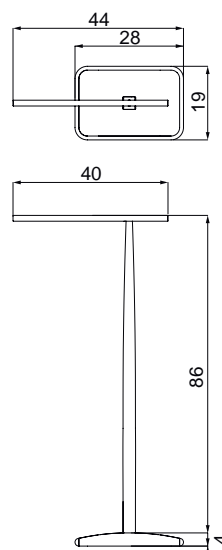
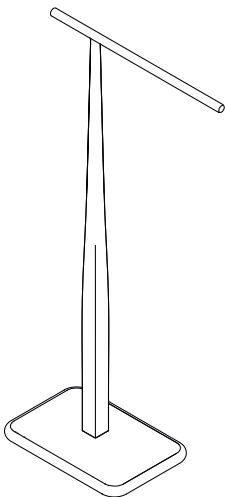
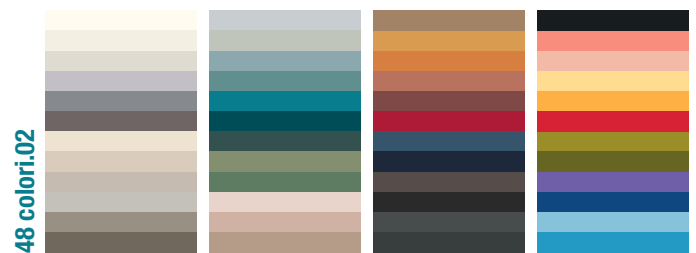

### Arock® & laccato OPACO Arock® & MATT lacquered Arock® & laqué MAT Arock® & MATT Lackiert

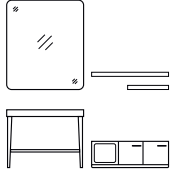
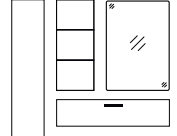
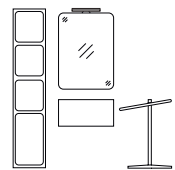

**Portasalvietta free-standing  
Towel stand**

**Porte-serviettes  
Handtuchhalter-stehend**

	 <p>ALCENTIMETRO PROGETTO</p>	 <p>Elementi CONTENITORI</p>	 <p>Elementi COMPLEMENTARI</p>	 <p>RICAMBI</p>
	98	180	226	592

**H 90**

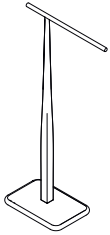

**P 44**

Portasalvietta free-standing  
Towel stand  
Porte-serviettes  
Handtuchhalter-stehend

**L**

19 GGKP4022

**F1**

**F5**

  
 Misure in cm  
 Measures in cm  
 Mesures en cm  
 Maße in cm

**F1** Laccato opaco  
Matt lacquered  
Laqué mat  
Matt lackiert

**F2** Laccato lucido  
Glossy lacquered  
Laqué brillant  
Hochglanz lackiert

**F3** Nobilitati  
Veneer wood  
Placage bois  
Beschichtetes Holz

**F4** Arock®  
Arock®  
Arock®  
Arock®

**F5** abitat / vogue  
abitat / vogue  
abitat / vogue  
abitat / vogue

**PORTASALVIETTE A MURO**





. struttura in alluminio anodizzato disponibile in finitura abitat e vogue  
o in 48 colori.02 laccato OPACO

. anodized aluminum structure available in abitat and vogue finishing  
or in 48 colori.02 MATT lacquered

. structure en aluminium anodisé disponible en finition abitat et vogue  
ou en 48 colori.02 MAT laqué

. eloxierte Aluminiumstruktur in abitat und vogue Ausführung erhältlich  
oder in 48 colori.02 MATT Lackiert

### abitat / vogue



### laccato OPACO MATT lacquered laqué MAT MATT Lackiert

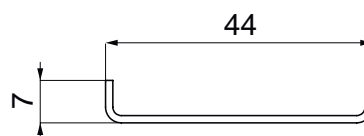
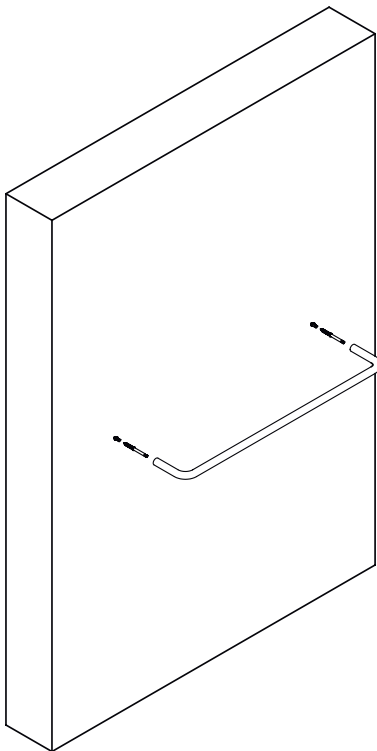
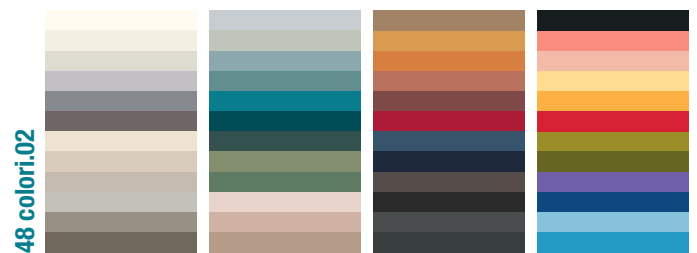

# Portasalviette a muro Towel rail

# Porte-serviettes à montage mural Wand-Handtuchhalter

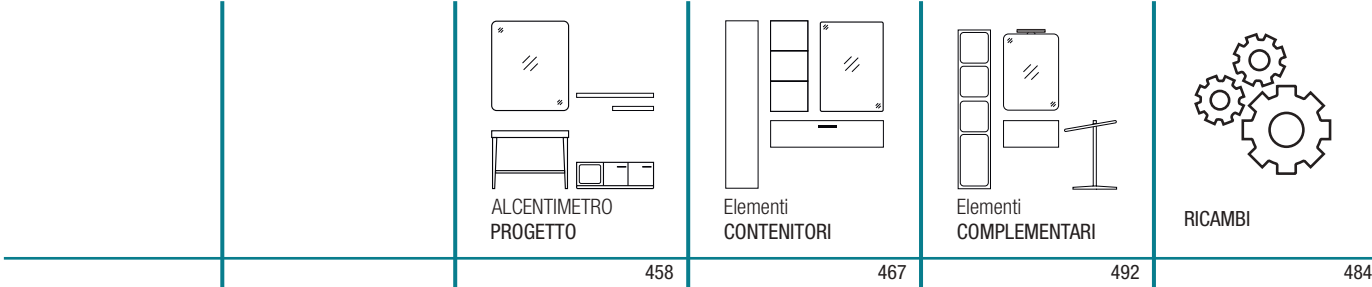

## P 7

Portasalviette a muro  
Towel rail  
Porte-serviettes à montage mural  
Wand-Handtuchhalter

### L

44 OMASAL01

### F1

### F5



Misure in cm  
Measures in cm  
Mesures en cm  
Maße in cm

**F1** Laccato opaco  
Matt lacquered  
Laqué mat  
Matt lackiert

**F2** Laccato lucido  
Glossy lacquered  
Laqué brillant  
Hochglanz lackiert

**F3** Nobilitati  
Veneer wood  
Placage bois  
Beschichtetes Holz

**F4** Arock®  
Arock®  
Arock®  
Arock®

**F5** abitat / vogue  
abitat / vogue  
abitat / vogue  
abitat / vogue

**MENSOLA AROCK® CON PORTASALVIETTE**









- . mensola in Arock® disponibile in 48 colori.02
- . ottenuta da stampo nelle dimensioni 17 x 54/63 x 12 cm
- . 1 tipologia di installazione, orizzontale
- . portasalviette in alluminio anodizzato disponibile in finitura abitat e vogue o in 48 colori.02 laccato OPACO

- . Arock® shelf available in 48 colori.02
- . molded in the dimensions 17 x 54/63 x 12 cm
- . 1 type of installation, horizontal
- . anodized aluminum towel holder available in abitat and vogue finishing or in 48 colori.02 MATT lacquered

- . étagère Arock® disponible en 48 colori.02
- . moulé aux dimensions 17 x 54/63 x 12 cm
- . 1 type d'installation, horizontale
- . porte-serviettes en aluminium anodisé disponible en finition abitat et vogue ou en 48 colori.02 MAT laqué

- . Arock® Regalelement in 48 colori.02
- . geformt in den Maßen 17 x 54/63 x 12 cm
- . 1 Montagearte, horizontal
- . eloxierte Aluminiumstruktur Handtuchhalter in abitat und vogue Ausführung erhältlich oder in 48 colori.02 MATT Lackiert

### abitat / vogue



### Arock® & laccato OPACO Arock® & MATT lacquered Arock® & laqué MAT Arock® & MATT Lackiert

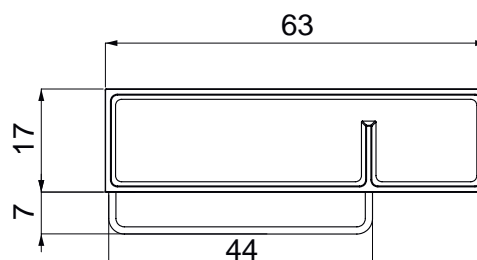
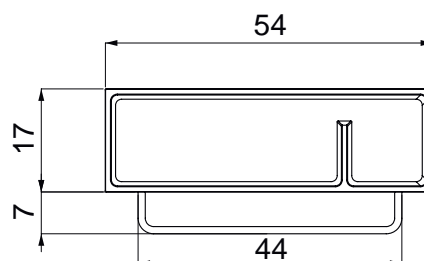
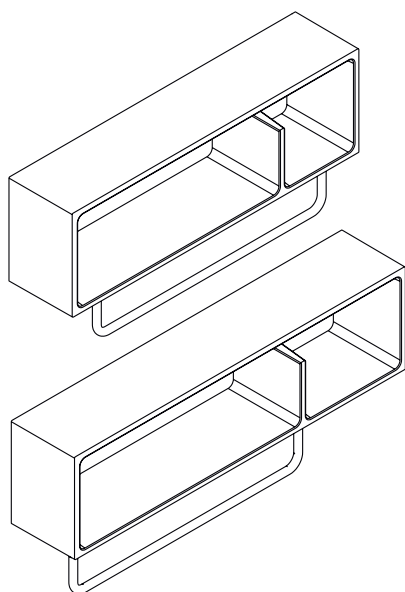

## Mensola Shelf

## Étagère Regalelement

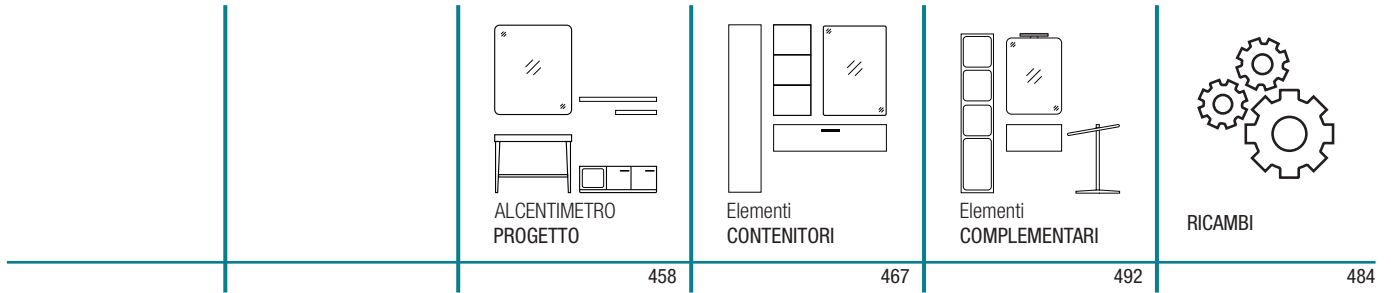
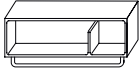
**H 17**

**P 12**

Mensola + portasalviette  
Shelf + towel rail  
Étagère + porte-serviettes  
Regalelement + Handtuchhalter

**L**

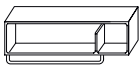
54 GGKM3054

**F1**
**F5**
**H 17**

**P 12**

Mensola + portasalviette  
Shelf + towel rail  
Étagère + porte-serviettes  
Regalelement + Handtuchhalter

**L**

63 GGKM3063

**F1**
**F5**

H  
L  
P

Misure in cm  
Measures in cm  
Mesures en cm  
Maße in cm

**F1** Laccato opaco  
Matt lacquered  
Laqué mat  
Matt lackiert

**F2** Laccato lucido  
Glossy lacquered  
Laqué brillant  
Hochglanz lackiert

**F3** Nobilitati  
Veneer wood  
Placage bois  
Beschichtetes Holz

**F4** Arock®  
Arock®  
Arock®  
Arock®

**F5** abitat / vogue  
abitat / vogue  
abitat / vogue  
abitat / vogue

- . mensola in Arock® disponibile in 48 colori.02
- . ottenuta da stampo nelle dimensioni 17 x 54/63 x 12 cm
- . 1 tipologia di installazione, orizzontale

- . Arock® shelf available in 48 colors.02
- . molded in the dimensions 17 x 54/63 x 12 cm
- . 1 type of installation, horizontal

- . étagère Arock® disponible en 48 couleurs.02
- . moulé aux dimensions 17 x 54/63 x 12 cm
- . 1 type d'installation, horizontale

- . Regalelement in 48 colors.02
- . geformt in den Maßen 17 x 54/63 x 12 cm
- . 1 Montagearte, horizontal

## Arock®

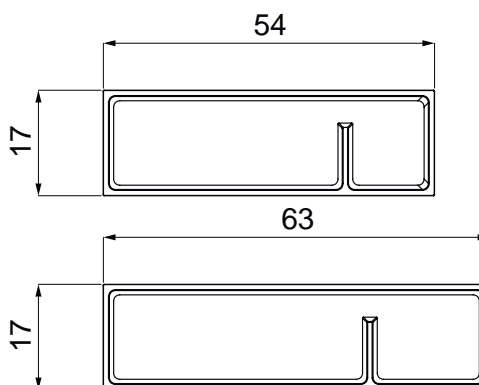
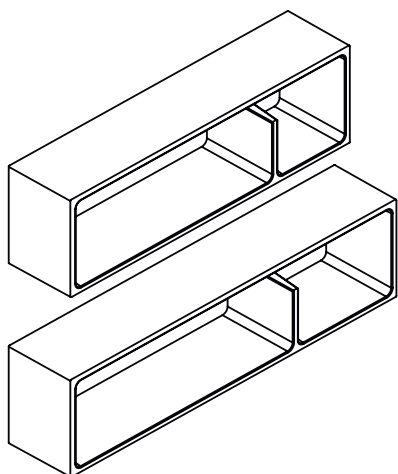
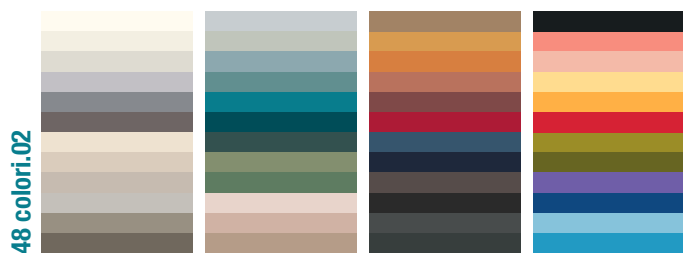

# Mensola Shelf

# Étagère Regalelement

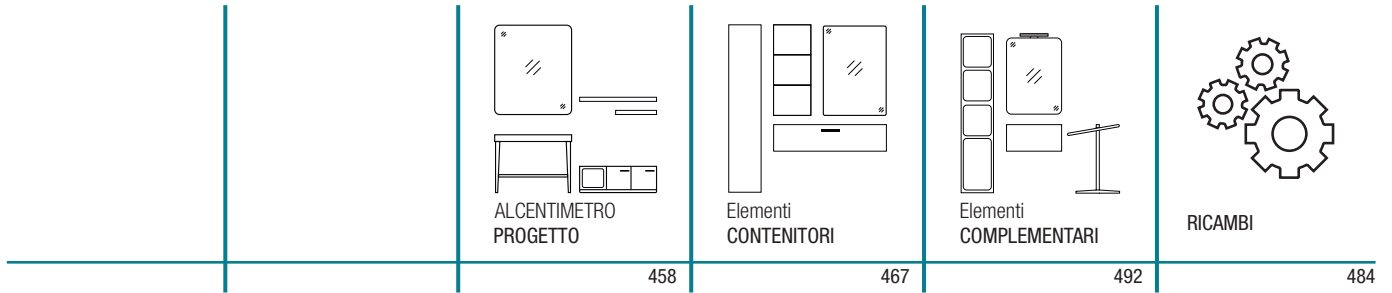

**H 17**

**P 12**

Mensola P 12  
Shelf P 12  
Étagère P 12  
Regalelement T 12

**L**

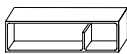
54 GGKM2054

**F4**
**H 17**

**P 12**

Mensola P 12  
Shelf P 12  
Étagère P 12  
Regalelement T 12

**L**

63 GGKM2063

**F4**

H  
L  
P

Misure in cm  
Measures in cm  
Mesures en cm  
Maße in cm

**F1** Laccato opaco  
Matt lacquered  
Laqué mat  
Matt lackiert

**F2** Laccato lucido  
Glossy lacquered  
Laqué brillant  
Hochglanz lackiert

**F3** Nobilitati  
Veneer wood  
Placage bois  
Beschichtetes Holz

**F4** Arock®  
Arock®  
Arock®  
Arock®

**F5** abitat / vogue  
abitat / vogue  
abitat / vogue  
abitat / vogue

COLONNINA E POMOLO / AROCK®

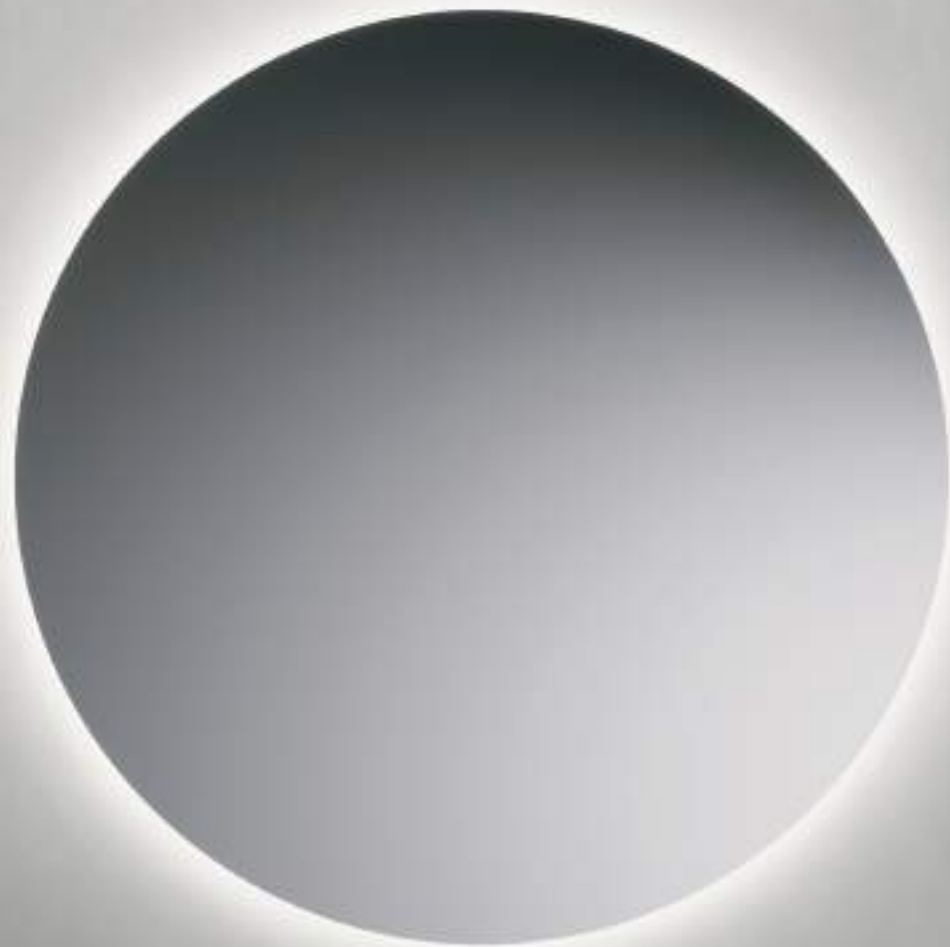
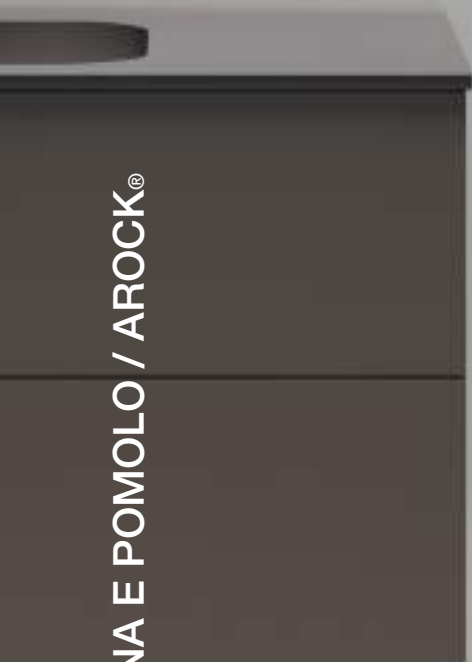



## COLONNINA

- . colonnina in Arock® disponibile in 48 colori.02
- . ottenuta da stampo nelle dimensioni 17 x 108 x 12 cm
- . 2 tipologie di installazione, orizzontale e verticale

- . Arock® shelving unit available in 48 colors.02
- . molded in the dimensions 17 x 108 x 12 cm
- . 2 types of installation, horizontal and vertical

- . étagère Arock® disponible en 48 colori.02
- . moulé aux dimensions 17 x 108 x 12 cm
- . 2 types d'installation, horizontale et verticale

- . Arock® Regalelement erhältlich in 48 colori.02
- . geformt in den Maßen 17 x 108 x 12 cm
- . 2 Montagearten, horizontal und vertikal

## Arock®

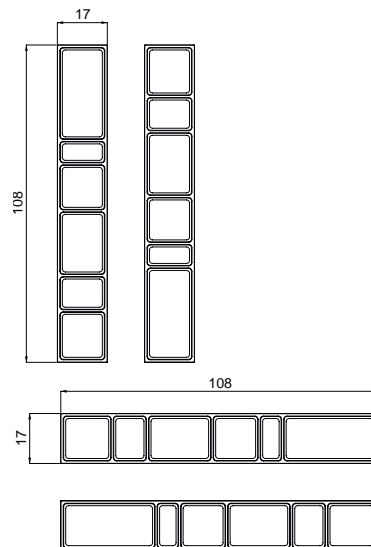
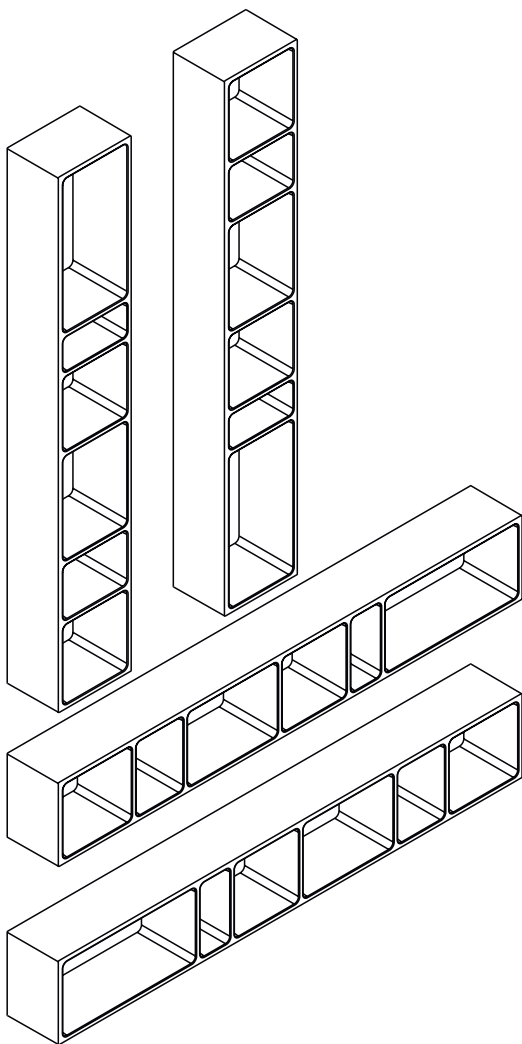
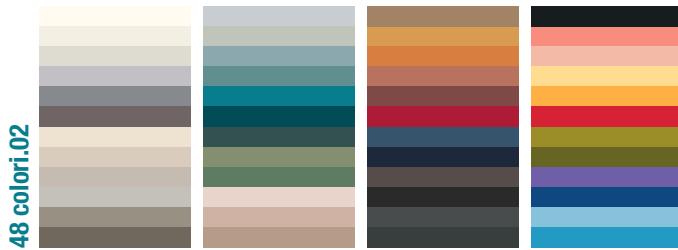



POMOLO

PORTASALVIETTE IN AROCK®

ELEMENTI

COMPLEMENTARI

- . pomolo in Arock® disponibile in 48 colori.02
- . ottenuto da stampo in dimensioni 20 x 11 x 6 cm
- . 2 tipologie di installazione, orizzontale e verticale

- . Arock® towel hook available in 48 colors.02
- . molded in the dimensions 20 x 11 x 6 cm
- . 2 types of installation, horizontal and vertical

- . porte-serviettes en Arock® disponible en 48 colori.02
- . moulé aux dimensions 20 x 11 x 6 cm
- . 2 types d'installation, horizontale et verticale

- . Arock® Handtuchhalter in 48 colori.02
- . geformt in den Maßen 20 x 11 x 6 cm
- . 2 Montagearten, horizontal und vertikal

Arock®

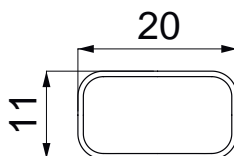
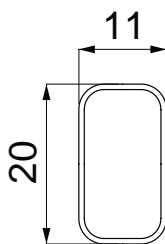
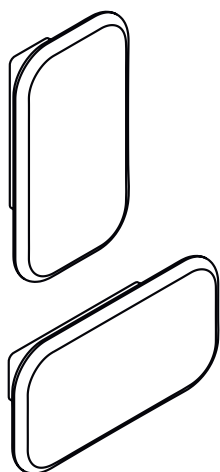
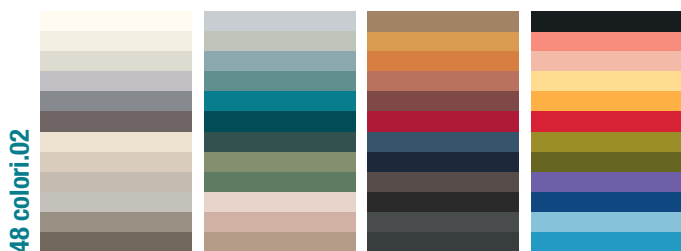

## Colonnina Shelving unit

## Étagère Regalelement

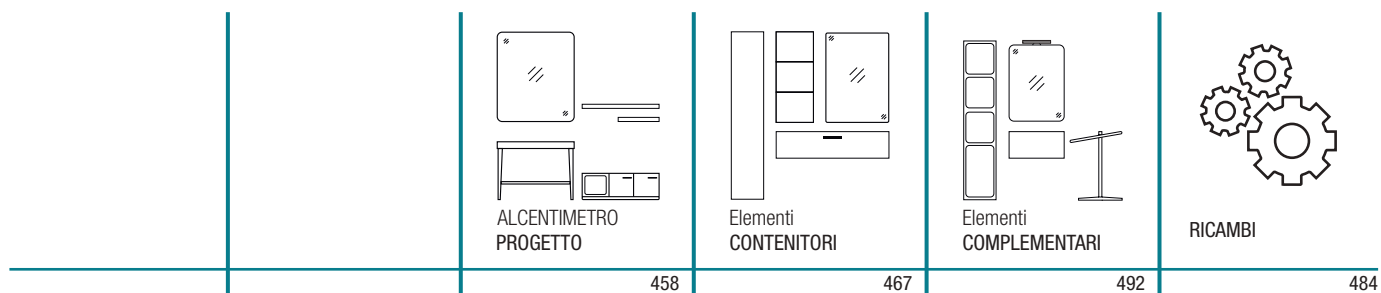
**H 17**

**P 12**

Colonnina P 12  
Shelving unit P 12  
Étagère P 12  
Regalelement T 12

**L**

108 GGKC2108

**F4**
**H 17**

**P 12**

Colonnina P 12  
Shelving unit P 12  
Étagère P 12  
Regalelement T 12

**L**

108 GGKC4108

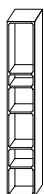
**F4**
**H 108**

**P 12**

Colonnina P 12  
Shelving unit P 12  
Étagère P 12  
Regalelement T 12

**L**

17 GGKC6108

**F4**

Misure in cm  
Measures in cm  
Mesures en cm  
Maße in cm

**F1** Laccato opaco  
Matt lacquered  
Laqué mat  
Matt lackiert

**F2** Laccato lucido  
Glossy lacquered  
Laqué brillant  
Hochglanz lackiert

**F3** Nobilitati  
Veneer wood  
Placage bois  
Beschichtetes Holz

**F4** Arock®  
Arock®  
Arock®  
Arock®

**F5** abitat / vogue  
abitat / vogue  
abitat / vogue  
abitat / vogue

## Colonnina Shelving unit

## Étagère Regalelement

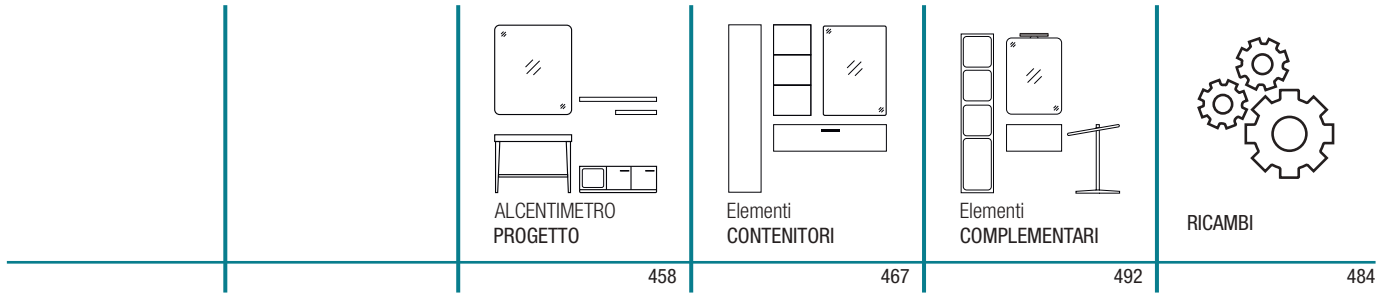

### H 108



### P 12

Colonnina P 12  
Shelving unit P 12  
Étagère P 12  
Regalelement T 12

**L**

17 GGKC8108

**F4**

### H 11



Pomolo  
Towel hook  
Porte-serviettes en Arock®  
Arock® Handtuschhalter

**L**

20 GGKP3017

**F4**

H  
L  
P

Misure in cm  
Measures in cm  
Mesures en cm  
Maße in cm

**F1** Laccato opaco  
Matt lacquered  
Laqué mat  
Matt lackiert

**F2** Laccato lucido  
Glossy lacquered  
Laqué brillant  
Hochglanz lackiert

**F3** Nobilitati  
Veneer wood  
Placage bois  
Beschichtetes Holz

**F4** Arock®  
Arock®  
Arock®  
Arock®

**F5** abitat / vogue  
abitat / vogue  
abitat / vogue  
abitat / vogue



MOBILI DISEGNATI

**SHAMBOLA**® di PAOLO SALVADÈ





## SHAMBOLA®

una struttura telaio totalmente in alluminio in due profondità con portasalviette opzionale, ripiano e lavabo filopiano integrato in Arock® definita CONSOLE

le gambe a terra portanti a sezione variabile integrano la forma tonda e quadra, esclusivo profilo smussato sottotop con finiture anodizzate e verniciate

nella sezione **ALCENTIMETRO PROGETTO**

**SHAMBOLA®** propone tutte le misure al centimetro, tutti i materiali e tutti i lavabi in appoggio o bordo soprapiano oltre alla versione TAVOLO

une structure de CONSOLE entièrement en aluminium en deux profondeurs avec en option un port-serviettes. Une étagère et un plan lavabo intégré en Arock®

les pieds d'appui au sol à section variable et le profile exclusif sous le dessus bisauté avec des finitions anodisées et lacquées

dans la section **ALCENTIMETRO PROGETTO**

**SHAMBOLA®** intègre toutes les mesures au centimetre, tous les matériaux, tous les lavabos et la version TAVOLO



a frame structure in aluminium with double depths. It has an optional rail, a shelf, and an integrated basin in Arock®. This is defined as CONSOLE

The supporting legs on the ground, as shown in the original project, integrate the round and square shapes.

Unique blunt under-top profile with anodized and total color varnished finishes

ALCENTIMETRO **PROGETTO** section

**SHAMBOLA®** integrates all the alcentimetro measures, materials, and basin types. In addition, Shambola includes a unique version, TAVOLO

eine KONSOLE mit Rahmenstruktur aus Aluminium mit doppelter Tiefe verfügt über eine optionale Reling, eine Regalelement und ein integriertes Becke

die Stützbeine auf dem Boden, wie im Originalprojekt gezeigt, integrieren die runden und eckigen Formen.

Einzigartiges stumpfes Unterprofil mit eloxierten und vollständig farblackierten Oberflächen

in der Sektion **ALCENTIMETRO PROGETTO**, **SHAMBOLA®** integriert alle Maßnahmen, Materialien und Beckentypen. Darüber hinaus enthält Shambola eine einzigartige Version, TAVOLO



## abitat / vogue

Arock® & laccato OPACO  
 Arock® & MATT lacquered  
 Arock® & laqué MAT  
 Arock® & MATT Lackiert

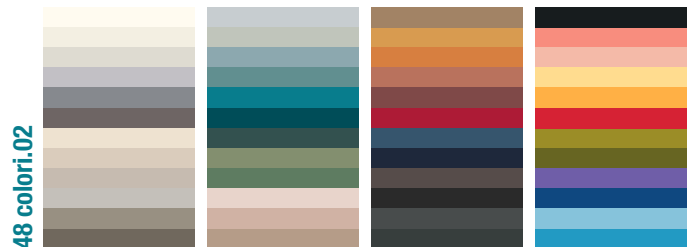
**A filopiano lavabo integrato / integrated plan washbasin / vasque en plan intégrée / integrierte Waschtischplatte**

INCLUSO nel prezzo  
 PROFONDITÀ : 45-51,5 cm  
 FINITURE: Arock® 1,2 cm 48 colori.02

INCLUDED in the price  
 DEPTH: 45-51,5 cm  
 FINISHES: Arock® 1,2 cm 48 colori.02

INCLUS dans le prix  
 PROFONDEUR: 45-51,5 cm  
 FINITIONS: Arock® 1,2 cm 48 colori.02

INKLUSIV im Preis  
 TIEFE: 45-51,5 cm  
 AUSFÜHRUNGEN: Arock® 1,2 cm 48 colori.02

**B struttura / structure / structure / Struktur**

struttura in alluminio anodizzato con due gambe frontali e ripiano portasalviette laterale OPZIONALE  
 ALTEZZA: 90 cm  
 PROFONDITÀ: 45-51,5 cm  
 LARGHEZZA: 70-80-90-100-110-120-140 cm  
 FINITURE: vogue/abitat & 48 colori.02

anodized aluminum structure with two front legs and one shelf side towel holder OPTIONAL  
 HEIGHT: 90 cm  
 DEPTH: 45-51,5 cm  
 WIDTH: 70-80-90-100-110-120-140 cm  
 FINISHES: vogue/abitat & 48 colori.02

structure en aluminium anodisé avec deux pieds et un étagère porte-serviettes latéral EN OPTION  
 HAUTEUR: 90 cm  
 PROFONDEUR: 45-51,5 cm  
 LARGEUR: 70-80-90-100-110-120-140 cm  
 FINITIONS: vogue/abitat & 48 colori.02

eloxierte Aluminiumstruktur mit zwei Vorderbeinen und ein Regal seitlicher Handtuchhalter OPTIONAL  
 HÖHE: 90 cm  
 TIEFE: 45-51,5 cm  
 BREITE: 70-80-90-100-110-120-140 cm  
 AUSFÜHRUNGEN: vogue/abitat & 48 colori.02

**C ripiano / shelf / étagère / Regal**

ripiano Arock® fissato in posizione predefinita a 25 cm da terra  
 SPESSORE: 1,2 cm  
 FINITURE: 48 colori.02

Arock® fixed shelf at 25 cm from soul  
 THICKNESS: 1,2 cm  
 FINISHES: 48 colori.02

étagère en Arock® fixée en une position définie à 25 cm du sol  
 ÉPAISSEUR: 1,2 cm  
 FINITIONS : 48 colori.02

Regal aus Arock® in Standardposition 25 cm über dem Boden  
 DICKE: 1,2 cm  
 AUSFÜHRUNGEN: 48 colori.02



**Modularità  
Modularity**

**Modularité  
Modularität**

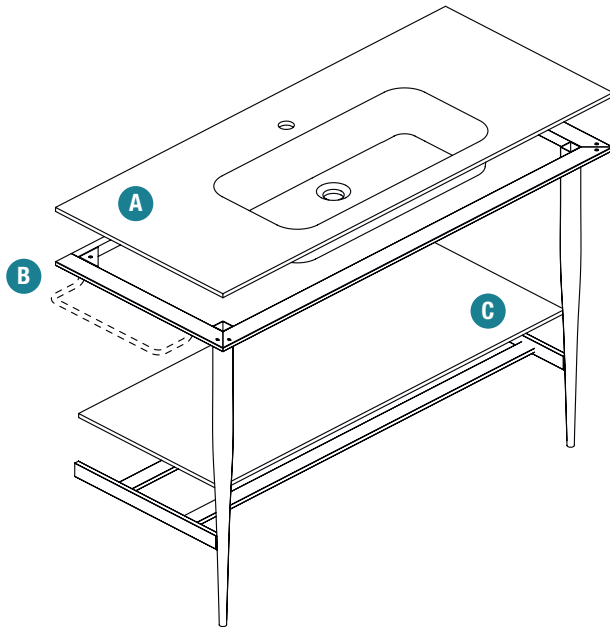
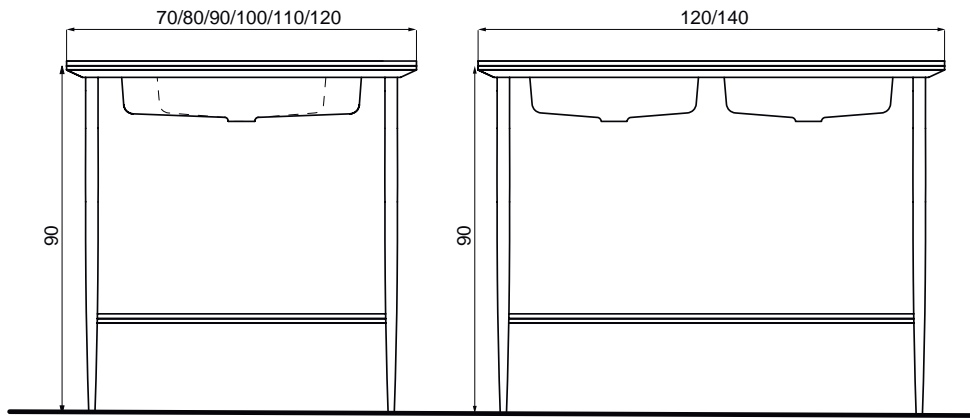

## AROCK®

Filopiano lavabo integrato  
 Integrated plan washbasin  
 Vasque en plan intégrée  
 Integrierte Waschtischplatte

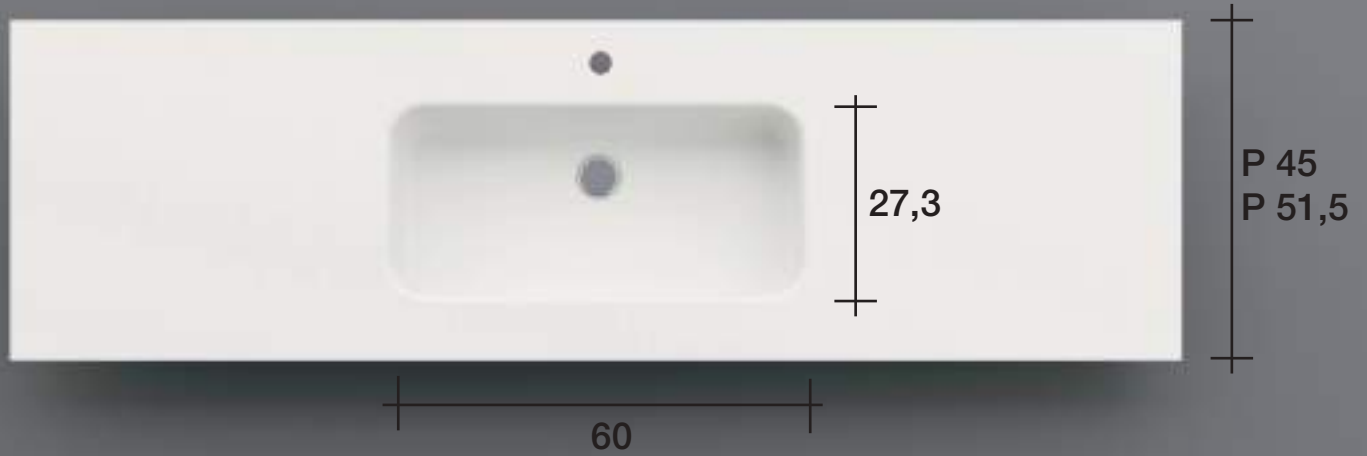

foro rubinetto incl.  
 tap hole incl.  
 trou pour le robinet incl.  
 Armaturbohrung inkl.

non provvisto di scarico troppopieno  
 without overflow system  
 sans système de trop-plein  
 ohne Überlaufsystem

kit piletta e sifone da ordinare separatamente  
 waste kit and siphon to be ordered separately  
 kit bonde d'évacuation et siphon à commander séparément  
 Ablauf Kit und Siphon müssen separat bestellt werden

Parte tecnica  
Technical section

Section technique  
Technischer Teil

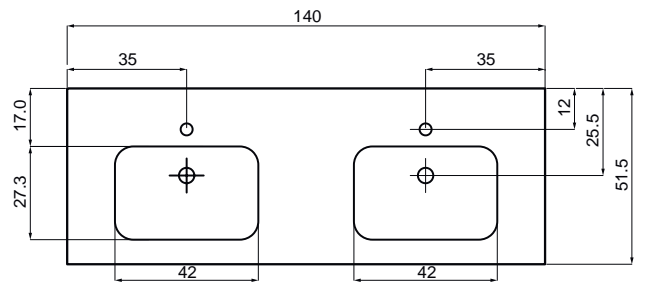
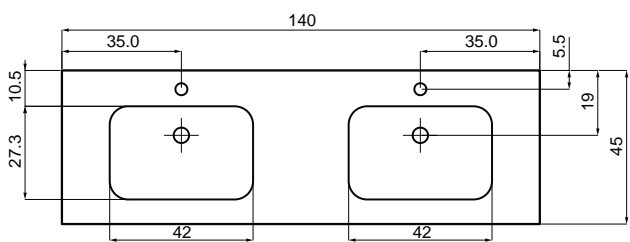
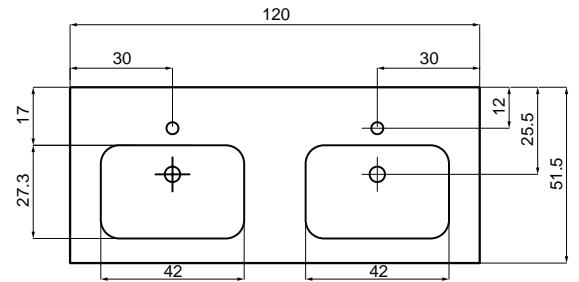
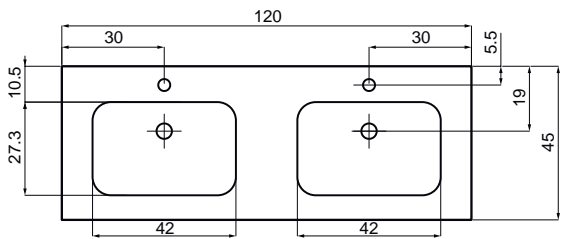
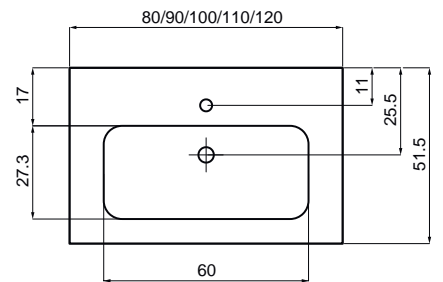
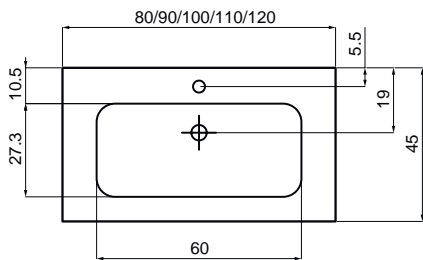
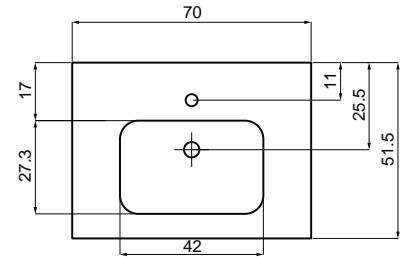
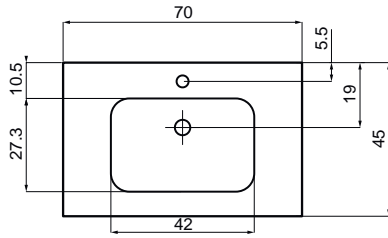







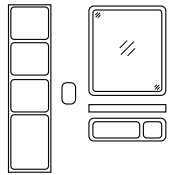
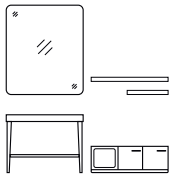
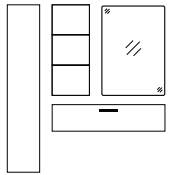
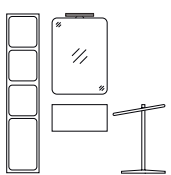

## Shambola®

				
UNICAMENTE AROCK®	ALCENTIMETRO PROGETTO	Elementi CONTENTORI	Elementi COMPLEMENTARI	RICAMBI
34	98	180	226	592

## H 90

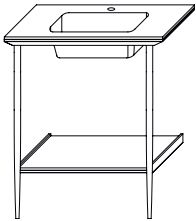

## P 45

Console + pianolavabo integrato Arock® vasca centrale L 42  
 Console + Arock® integrated central basin W 42  
 Console + centrale vasque intégrée au plan Arock® L 42  
 Konsole Struktur-stehend + Arock® Integrierte Plan-Waschtisch zentrale-Waschtisch B 42

L	F1	F5	
70 CLA07000			

## P 51,5

L	F1	F5	
70 CLB07000			

## H 90

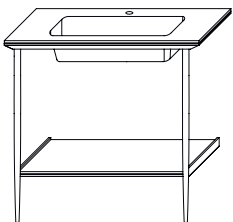

## P 45

Console + pianolavabo integrato Arock® vasca centrale L 60  
 Console + Arock® integrated central basin W 60  
 Console + centrale vasque intégrée au plan Arock® L 60  
 Konsole Struktur-stehend + Arock® Integrierte Plan-Waschtisch zentrale-Waschtisch B 60

L	F1	F5	
80 CLA08001			
90 CLA09001			
100 CLA10001			
110 CLA11001			
120 CLA12001			

## P 51,5

L	F1	F5	
80 CLB08001			
90 CLB09001			
100 CLB10001			
110 CLB11001			
120 CLB12001			

## H 90

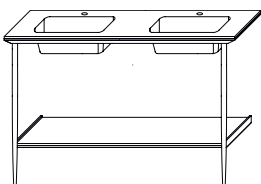

## P 45

Console + pianolavabo integrato Arock® doppia vasca L 42  
 Console + Arock® integrated double basin W 42  
 Console + double vasque intégrée au plan Arock® L 42  
 Konsole Struktur-stehend + Arock® Integrierte Plan-Waschtisch doppel-Waschtisch B 42

L	F1	F5	
120 CLA12006			
140 CLA14006			

## P 51,5

L	F1	F5	
120 CLB12006			
140 CLB14006			



Misure in cm  
 Measures in cm  
 Mesures en cm  
 Maße in cm

**F1** Laccato opaco  
 Matt lacquered  
 Laqué mat  
 Matt lackiert

**F2** Laccato lucido  
 Glossy lacquered  
 Laqué brillant  
 Hochglanz lackiert





**F3** Nobilitati  
 Veneer wood  
 Placage bois  
 Beschichtetes Holz

**F4** Arock®  
 Arock®  
 Arock®

**F5** abitat / vogue  
 abitat / vogue  
 abitat / vogue  
 abitat / vogue

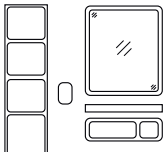
**Portasalviette per console**  
**Console towel holder**

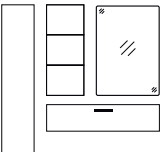
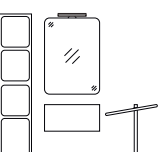
**Porte-serviettes à console**  
**Handtuchhalter für Konsole**

 <p>UNICAMENTE AROCK®</p>	 <p>ALCENTIMETRO PROGETTO</p>	 <p>Elementi CONTENITORI</p>	 <p>Elementi COMPLEMENTARI</p>	 <p>RICAMBI</p>
34	98	180	226	592



**P 7**

Portasalviette per console - FACOLTATIVO  
 Console towel holder - OPTIONAL  
 Porte-serviettes à console - OPTIONNEL  
 Handtuchhalter für Konsole Struktur-stehend - OPTIONAL



**L**

34,5 OMASAL02

**F1**

**F5**

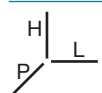

Misure in cm  
 Measures in cm  
 Mesures en cm  
 Maße in cm

**F1**

Laccato opaco  
 Matt lacquered  
 Laqué mat  
 Matt lackiert

**F2**

Laccato lucido  
 Glossy lacquered  
 Laqué brillant  
 Hochglanz lackiert

**F3**

Nobilitati  
 Veneer wood  
 Placage bois  
 Beschichtetes Holz

**F4**

Arock®  
 Arock®  
 Arock®  
 Arock®

**F5**

abitat / vogue  
 abitat / vogue  
 abitat / vogue  
 abitat / vogue





MOBILI DISEGNATI

**TALETE** di PAOLO SALVADÈ



# T A L E T E

il fianco inclinato ingentilisce la capiente profondità, il frontale arretrato è protetto dagli schizzi

la sfaccettatura verticale smussata ha un carattere inedito e prosegue nel profilo orizzontale anch'esso inclinato. Una maniglia coordinata in aggiunta al Sistema Premi-Aprì

sul filopiano lavabo integrato in Arock® una soglia posteriore di appoggio dedicato a contenimento e non ultimo uno spaccafilo salvagoccia sottotop

le côté incliné affine la prondeur specieuse, l'avant en arrière est protégé des éclaboussures

la facette verticale biseautée a un nouveau caractère et se poursuit dans le profil horizontal incliné. En ajoute au Système Premi-Aprì il y a une poignée coordonnée

sur la vasque intégrée en Arock® un seuil et surtout un séparateur antigoutte sous le plan vasque





the inclined side softens the large depth, the backlog front side is protected from the water

the vertical blunt facet has a new style and continues into the horizontal profile, which is inclined as well. Alternatively, the Premi-Apri system is the matchy handle

on the Arock® integrated basin there is a backside support threshold dedicated to containing. In addition, Talete presents an under-top drip-catcher profile

die schräge Seite mildert die große Tiefe, die Stirnseite des Rückstands wird durch Spritzer geschützt

die vertikale stumpfe Facette hat einen neuen Stil und setzt sich in dem ebenfalls geneigten horizontalen Profil fort. Zusätzlich zum System Premi-Apri eine passende Griff

auf dem integrierten Becken Arock® gibt es eine rückseitige Stützschwelle, die dem Einschließen gewidmet ist. Darüber hinaus präsentiert Talete ein Unterbecken-Tropffängerprofil



**A** piano / top / plan / Platte

TIPOLOGIE:

**filopiano lavabo integrato disegnato P 54 / integrated plan washbasin P 54 / vasque en plan intégrée P 54 / integrierte Waschtischplatte P 54**

DISEGNATO CON BASELLO  
NON INCLUSO nel prezzo  
PROFONDITÀ: 54 cm  
FINITURE: Arock® 1,2 cm 48 colori.02

DESIGNED WITH BASELLO  
NOT INCLUDED in the price  
DEPTH: 54 cm  
FINISHES: Arock® 1,2 cm 48 colori.02

CONÇU AVEC BASELLO  
PAS INCLUS dans le prix  
PROFONDEUR: 54 cm  
FINITIONS: Arock® 1,2 cm 48 colori.02

ENTWORFEN MIT BASELLO  
NICHT INKLUSIV im Preis  
TIEFE: 54 cm  
AUSFÜHRUNGEN: Arock® 1,2 cm 48 colori.02

per lavabo sopra piano da appoggio e da incasso e sottopiano da incasso

for countertop basin, recessed basin and undermounted basin

pour lavabo à poser, lavabo encastré surélevé et lavabo encastré  
PROFONDEUR : 54 cm

für Aufsatzwaschtisch, Halbeinbaubecken und Einbauwaschtisch

PROFONDITÀ: 54 cm  
FINITURE: Arock® - HPL - Nobilitato LEGNO/ALTATTO - Laccato OPACO/LUCIDO - GRES - PIETRA NATURALE - SILESTONE

DEPTH: 54 cm  
FINISHES: Arock® - HPL - Nobilitato LEGNO/ALTATTO - Laquered OPACO/LUCIDO - GRES - PIETRA NATURALE - SILESTONE

FINITIONS: Arock® - HPL - Mélangé BOIS/ALTATTO - Laque MAT/BRILLANT - GRES - PIERRE NATURELLE - SILESTONE

TIEFE: 54 cm  
AUSFÜHRUNGEN: Arock® - HPL - Melamin HOLZ/ALTATTO - MAT/GLOSS Lack - GRES - NATURSTEIN - SILESTONE

**B** contenitore / interior configuration / configuration intérieure / Innenausstattung

realizzato in pannelli di particelle di legno di spessore 18 mm, idrofughi, nobilitato con carta melaminica colore URBAN. Bordi in ABS in tinta  
. FIANCO SVASATO IN MDF LACCATO  
. SPACCAFILO SOTTOTOP 3 mm  
. PROFILO IN ALLUMINIO LACCATO  
Cassetto montato su guide GRASS® ad estrazione totale con sponde laterali in metallo verniciato colore URBAN. Fondo e schienale nella finitura del contenitore  
ALTEZZA: 48-87 cm  
PROFONDITÀ: 54 cm  
LARGHEZZA: 80-90-100-110-120-140 cm

made of water repellent panels of 18 mm thick wood particles, covered with Nobilitato URBAN color.  
Matching ABS edges  
. FLARED MDF LACQUERED SIDE PANEL  
. UNDER TOP PROFILE 3 mm  
. LACQUERED ALUMINIUM PROFILE  
Drawer mounted on full extension GRASS® runners with URBAN color painted metal sides. Bottom and back in the finish of the container  
HEIGHT: 48-87 cm  
DEPTH: 54 cm  
WIDTH: 80-90-100-110-120-140 cm

en panneaux hydrofuges en particules de bois de 18 mm d'épaisseur. Recouvert de papier mélaminé couleur URBAN. Bords ABS de la même couleur  
. PANNEAUX EN MDF ÉVASÉ ET LAQUÉ  
. PROFILÉ SOUS PLAN 3 mm  
. PROFILÉ EN ALUMINIUM LAQUÉ  
Tiroir monté sur coulisses GRASS® pleine extension avec côtés en métal peint couleur URBAN. Fond et retour dans la finition du intérieur  
HAUTEUR: 48-87 cm  
PROFONDEUR: 54 cm  
LARGEUR: 80-90-100-110-120-140 cm

in wasserabweisenden Platten aus 18 mm starken Holzpartikeln. Farbmelaminpapier und ABS Kanten der gleichen Farbe  
. MDF LACKIERTE SEITENPANEL  
. UNTERTOP PROFIL 3 mm  
. LACKIERTES ALUMINIUMPROFIL  
Schublade montiert auf GRASS® Vollauszügen mit URBAN-farbig lackierten Metallseiten. Boden und Rückseite im Abgang des Behälters  
HÖHE: 48-87 cm  
TIEFE: 54 cm  
BREITE: 80-90-100-110-120-140 cm

**C** frontali / front panels / tiroirs / Schublade

realizzato in pannelli di particelle di legno idrofugo nobilitato con carta melaminica  
SPESSORE: 1,8 cm  
FINITURE: Laccato OPACO/LUCIDO 48 colori.02 - Nobilitato LEGNO

made of water repellent panels of wood particles  
THICKNESS: 1,8 cm  
FINISHES: MATT/GLOSSY Lacquered 48 colori.02 - Nobilitato LEGNO

en panneaux hydrofuges en particules de bois recouvert de papier mélaminé  
ÉPAISSEUR: 1,8 cm  
FINITIONS: Laqué MAT/BRILLANT en 48 colori.02 - Nobilitato LEGNO

aus wasserabweisenden Spanplatten, veredelt mit Melaminpapier  
DICKE: 1,8 cm  
OBERFLÄCHEN: MATT/HOCHGLANZ Lack aus 48 colori.02 - Nobilitato LEGNO

**D** apertura / opening system / système d'ouverture / Öffnungssystem

Sistema Premi-Aprì  
Maniglia OPZIONALE  
FINITURA: Laccato OPACO 48 colori.02

Premi-Aprì System (soft-close)  
Handle OPTIONAL  
FINISHES: MATT Lacquered 48 colori.02

Système Premi-Aprì (soft-close)  
Poignée EN OPTION  
FINITION: Laqué MAT en 48 colori.02

Premi-Aprì System (soft-close)  
Griff OPTIONAL  
OBERFLÄCHEN: MATT Lack aus 48 colori.02

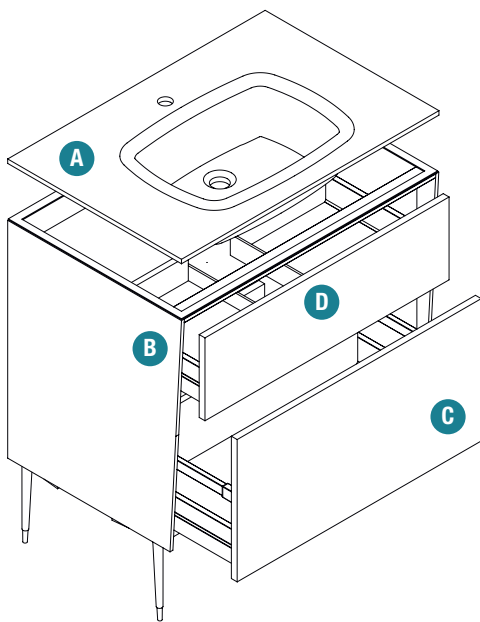
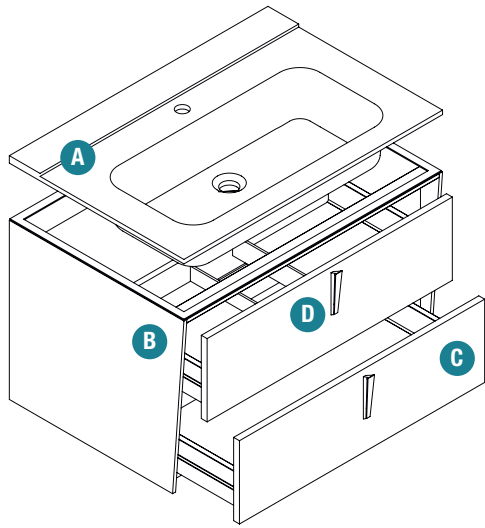

## Nobilitato LEGNO

pannello di particelle di legno spessore 18 mm idrofugo a basso contenuto di formaldeide nobilitato interno ed esterno con carta melaminica in finitura LEGNO riprodotto ad alta fedeltà; bordo in ABS in finitura

high pressure layered laminate, a perfect and strong imitation of the natural wooden surface

stratifiés décoratifs haute pression. Plaques à base de résines thermoscurcissables appelées stratifiés

Hochdruckmehrschichtlaminat mit einer dreidimensionalen Erscheinung

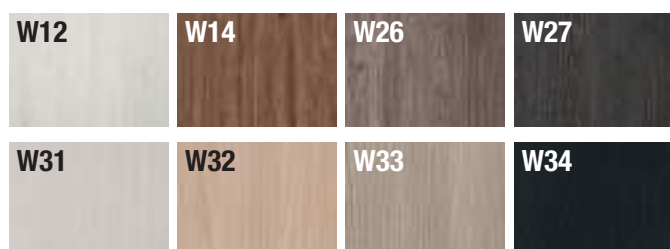

## laccato OPACO / LUCIDO MATT / GLOSSY lacquered

pannello di particelle di legno, idrofugo, a basso contenuto di formaldeide, verniciato con resine poliuretatiche pigmentate opache o lucide

wood particles panel 18 mm with low formaldehyde content, painted with polyurethane resins

## laqué MAT / BRILLANT MATT / HOCHGLANZ lackiert

panneaux de particules de bois 18 mm à faible teneur en formaldéhyde, peint avec des résines de polyuréthane

Holzpartikelplatte 18 mm mit niedrigem Formaldehydgehalt, mit Polyurethanharzen lackiert

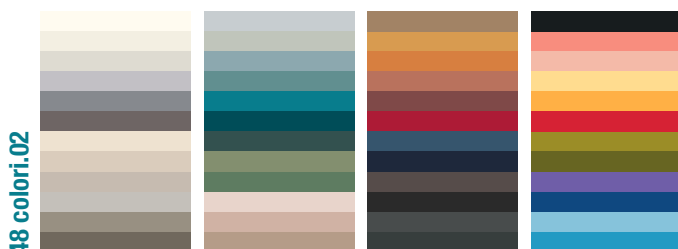

### Coppia Maniglie OPZIONALE

FINITURA:  
laccato OPACO 48 colori.02  
2 pz. € 70

### Handle

FINISHES:  
MATT lacquered 48 colori.02  
2 pz. € 70

### Poignée

FINITION:  
laqué MAT 48 colori.02  
2 pz. € 70

### Griffe

OBERFLÄCHEN:  
MATT lackiert 48 colori.02  
2 pz. € 70



**Modularità**  
**Modularity**

**Modularité**  
**Modularität**

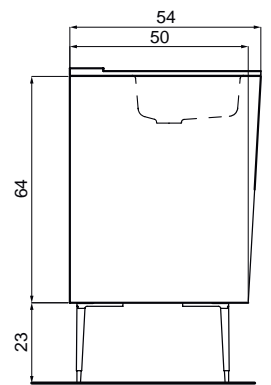
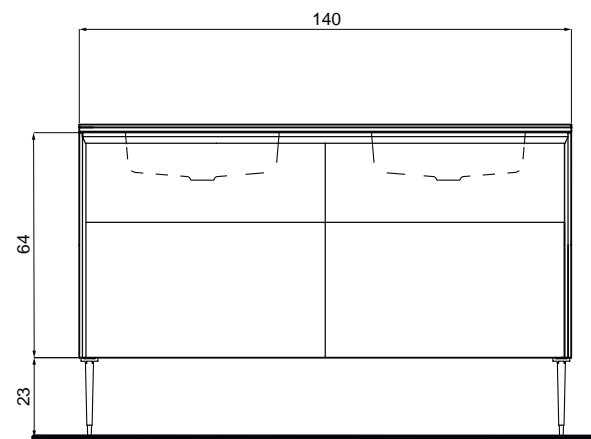
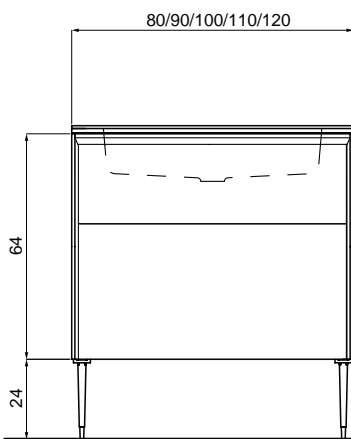
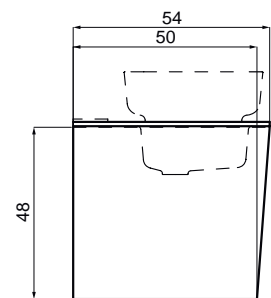
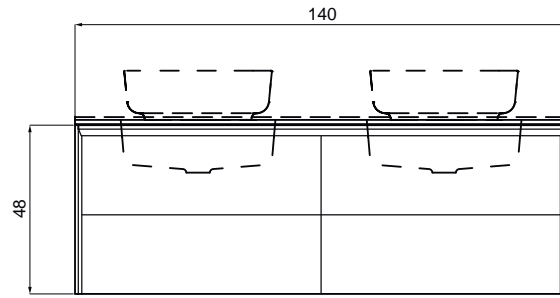
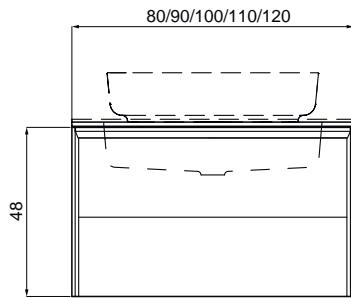

i colori qui riportati sono da considerarsi indicativi  
 the colours can diverge from the reality  
 la fidélité des couleurs peut être différent de la réalité  
 bitte berücksichtigen Sie unsere Farbfächer zur Farbauswahl

## AROCK®

Filopiano lavabo integrato  
 Integrated plan washbasin  
 Vasque en plan intégrée  
 Integrierte Waschtischplatte

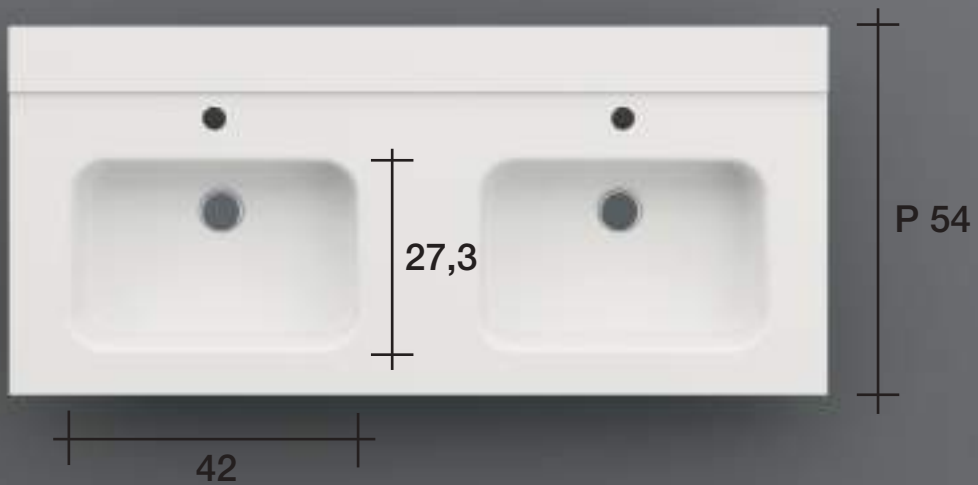
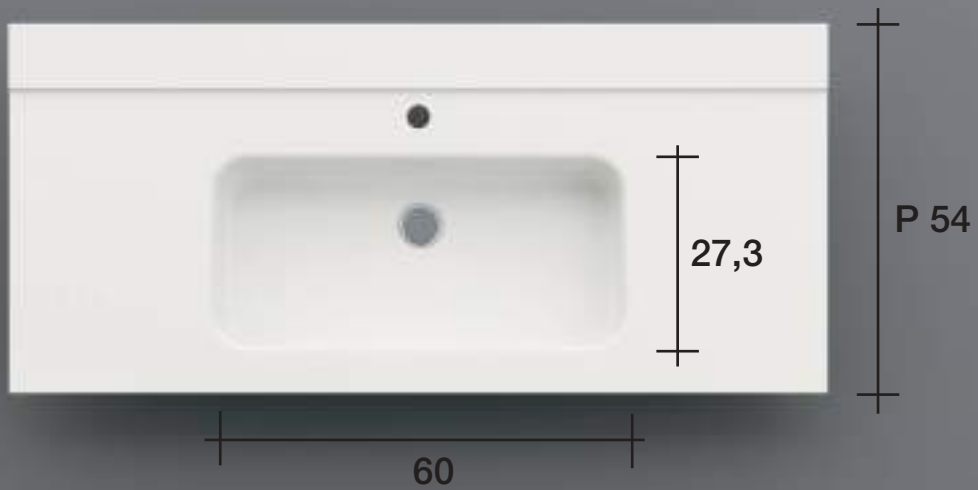

foro rubinetto incl.  
 tap hole incl.  
 trou pour le robinet incl.  
 Armaturbohrung inkl.

non previsto di scarico troppopieno  
 without overflow system  
 sans système de trop-plein  
 ohne Überlaufsystem

kit piletta e sifone da ordinare separatamente  
 waste kit and siphon to be ordered separately  
 kit bonde d'évacuation et siphon à commander séparément  
 Ablauf Kit und Siphon müssen separat bestellt werden

Parte tecnica  
 Technical section

Section technique  
 Technischer Teil

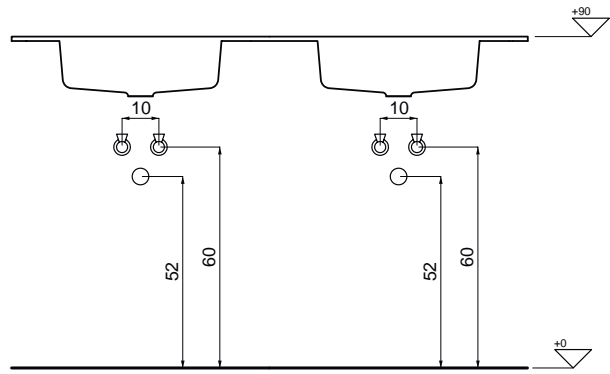
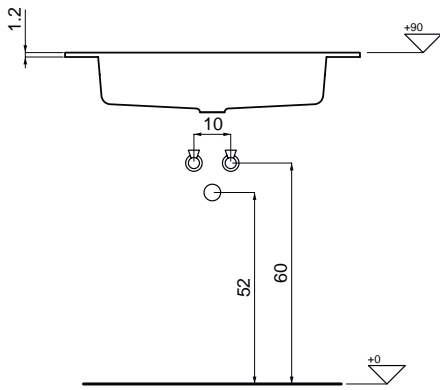
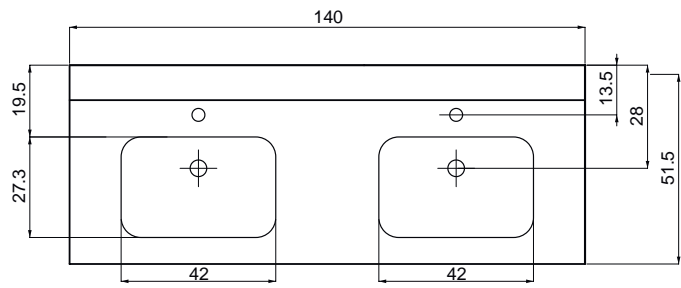
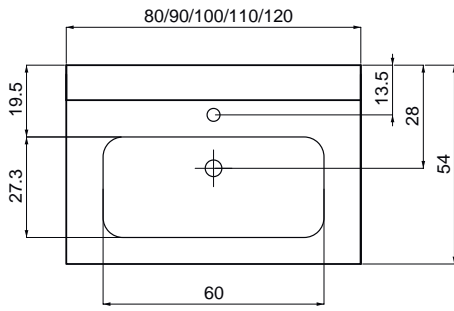

## piani / tops / plans / \Platten

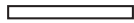

piano e piano d'arredo  
top for interior  
plan pour l'ameublement  
Platte fuer Einrichtung

piano e piano d'arredo accoppiato  
coated  
accouplé  
verdoppelt

## lavabo / basin / vasque / Becken

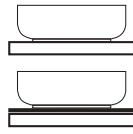

soprapiano da appoggio  
countertop basin  
lavabo à poser  
Aufsetzbecken

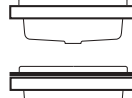

soprapiano da incasso  
recessed basin  
lavabo encastré surélevé  
Halbeinbaubecken



sottopiano da incasso  
undermounted basin  
lavabo en profondeur  
Unteneinbaubecken

	SP cm	P 54 cm	
AROCK®	1,2 / 6		
Laccato OPACO / LUCIDO	1,8		
Nobilitato LEGNO / ALTATTO	1,8		
Nobilitato LEGNO / ALTATTO + GRES Laccato OPACO / LUCIDO + GRES	2,4		
HPL	1		
GRES	0,6 / 1,2		
	1,2		
PIETRA NATURALE NATURAL STONE PIERRE NATURELLE NATURSTEIN	2		
SILESTONE	1,2		









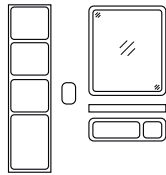
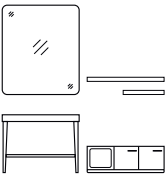
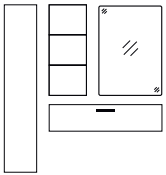
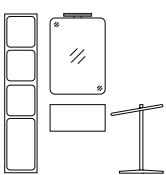

# Basi Units

# Meubles bas Unterschränke

				
UNICAMENTE AROCK®	ALCENTIMETRO PROGETTO	Elementi CONTENTORI	Elementi COMPLEMENTARI	RICAMBI
34	98	180	226	594

## H 48

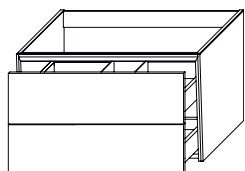

## P 54

Sistema Premi-Apri • base portalavabo • 2 cassetti • sifone incl.  
 Premi-Apri System • vanity unit • 2 pull-out • siphon incl.  
 Système Premi-Apri • meuble sous vasque • 2 tiroirs • siphon incl.  
 Premi-Apri System • Waschtischunterschrank • 2 Schubladen • Siphon inkl.

L	F1	F2	F3
80	TAL08031		
90	TAL09031		
100	TAL10031		
110	TAL11031		
120	TAL12031		

## H 48

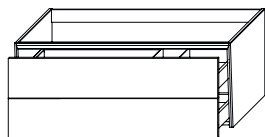

## P 54

Sistema Premi-Apri • base portalavabo • 2 cassetti • sifone incl.  
 Premi-Apri System • vanity unit • 2 pull-out • siphon incl.  
 Système Premi-Apri • meuble sous vasque • 2 tiroirs • siphon incl.  
 Premi-Apri System • Waschtischunterschrank • 2 Schubladen • Siphon inkl.

L	F1	F2	F3
120	TAL12032		

## H 48

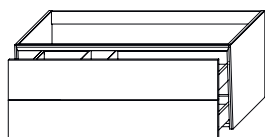

## P 54

Sistema Premi-Apri • base portalavabo • 2 cassetti • sifone incl.  
 Premi-Apri System • vanity unit • 2 pull-out • siphon incl.  
 Système Premi-Apri • meuble sous vasque • 2 tiroirs • siphon incl.  
 Premi-Apri System • Waschtischunterschrank • 2 Schubladen • Siphon inkl.

L	F1	F2	F3
120	TAL12033		



Misure in cm  
 Measures in cm  
 Mesures en cm  
 Maße in cm

**F1** Laccato opaco  
 Matt lacquered  
 Laqué mat  
 Matt lackiert

**F2** Laccato lucido  
 Glossy lacquered  
 Laqué brillant  
 Hochglanz lackiert

**F3** Nobilitati  
 Veneer wood  
 Placage bois  
 Beschichtetes Holz

**F4** Arock®  
 Arock®  
 Arock®  
 Arock®

**F5** abitat / vogue  
 abitat / vogue  
 abitat / vogue  
 abitat / vogue



# Basi Units

# Meubles bas Unterschränke

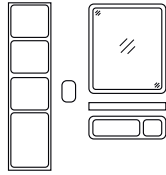

UNICAMENTE  
AROCK®

34

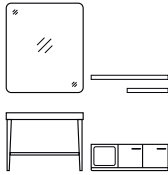

ALCENTIMETRO  
PROGETTO

98

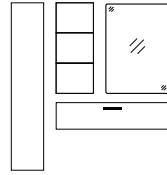

Elementi  
CONTENITORI

180

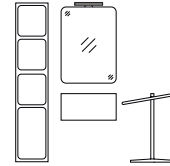

Elementi  
COMPLEMENTARI

226



RICAMBI

594

## H 48

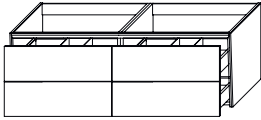

## P 54

Sistema Premi-Apri • base portalavabo • 4 cassetti • sifone incl.  
Premi-Apri System • vanity unit • 4 pull-out • siphon incl.  
Système Premi-Apri • meuble sous vasque • 4 tiroirs • siphon incl.  
Premi-Apri System • Waschtischunterschrank • 4 Schubladen • Siphon inkl.

### L

140 TAL14034

### F1

### F2

### F3

## H 87

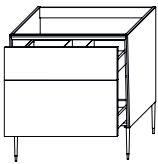

## P 54

Sistema Premi-Apri • base portalavabo • 2 cassetti • piedini + sifone incl.  
Premi-Apri System • vanity unit • 2 pull-out • legs + siphon incl.  
Système Premi-Apri • meuble sous vasque • 2 tiroirs • pieds + siphon incl.  
Premi-Apri System • Waschtischunterschrank • 2 Schubladen • Füße + Siphon inkl.

### L

80 TAL08061

90 TAL09061

100 TAL10061

110 TAL11061

120 TAL12061

### F1

### F2

### F3

## H 87

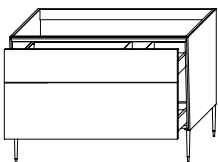

## P 54

Sistema Premi-Apri • base portalavabo • 2 cassetti • piedini + sifone incl.  
Premi-Apri System • vanity unit • 2 pull-out • legs + siphon incl.  
Système Premi-Apri • meuble sous vasque • 2 tiroirs • pieds + siphon incl.  
Premi-Apri System • Waschtischunterschrank • 2 Schubladen • Füße + Siphon inkl.

### L

120 TAL12062

### F1

### F2

### F3



Misure in cm  
Measures in cm  
Mesures en cm  
Maße in cm

### F1

Laccato opaco  
Matt lacquered  
Laqué mat  
Matt lackiert

### F2

Laccato lucido  
Glossy lacquered  
Laqué brillant  
Hochglanz lackiert

### F3

Nobilitati  
Veneer wood  
Placage bois  
Beschichtetes Holz

### F4





Arock®  
Arock®  
Arock®

### F5

abitat / vogue  
abitat / vogue  
abitat / vogue  
abitat / vogue

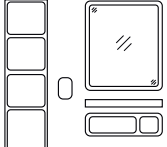
## Basi Units

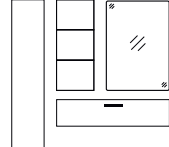
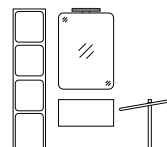
## Meubles bas Unterschränke

				
UNICAMENTE AROCK®	ALCENTIMETRO PROGETTO	Elementi CONTENITORI	Elementi COMPLEMENTARI	RICAMBI
34	98	180	226	594

### H 87

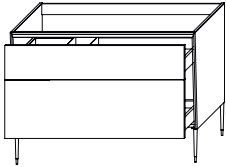

### P 54

Sistema Premi-Apri • base portalavabo • 2 cassetti • piedini + sifone incl.  
 Premi-Apri System • vanity unit • 2 pull-out • legs + siphon incl.  
 Système Premi-Apri • meuble sous vasque • 2 tiroirs • pieds + siphon incl.  
 Premi-Apri System • Waschtischunterschrank • 2 Schubladen • Füße + Siphon inkl.

**L**

120 TAL12063

**F1**
**F2**
**F3**

### H 87

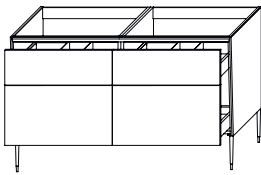

### P 54

Sistema Premi-Apri • base portalavabo • 4 cassetti • piedini + sifone incl.  
 Premi-Apri System • vanity unit • 4 pull-out • legs + siphon incl.  
 Système Premi-Apri • meuble sous vasque • 4 tiroirs • pieds + siphon incl.  
 Premi-Apri System • Waschtischunterschrank • 4 Schubladen • Füße + Siphon inkl.

**L**

140 TAL14064

**F1**
**F2**
**F3**

H  
L  
P

Misure in cm  
 Measures in cm  
 Mesures en cm  
 Maße in cm

**F1** Laccato opaco  
 Matt lacquered  
 Laqué mat  
 Matt lackiert

**F2** Laccato lucido  
 Glossy lacquered  
 Laqué brillant  
 Hochglanz lackiert

**F3** Nobilitati  
 Veneer wood  
 Placage bois  
 Beschichtetes Holz

**F4** Arock®  
 Arock®  
 Arock®  
 Arock®

**F5** abitat / vogue  
 abitat / vogue  
 abitat / vogue  
 abitat / vogue

## Pianolavabo integrato Integrated basin

## Plan-vasque intégrée Integrierte plan-Waschtisch

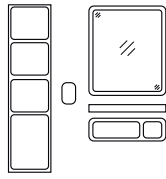

UNICAMENTE  
AROCK®

34

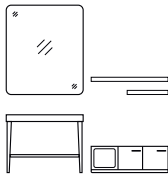

ALCENTIMETRO  
PROGETTO

98

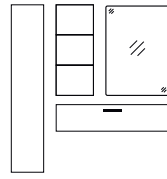

Elementi  
CONTENTORI

180

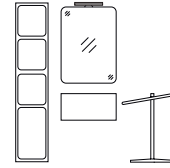

Elementi  
COMPLEMENTARI

226



RICAMBI

592



### P 54

Pianolavabo integrato  
Integrated basin  
Plan-vasque intégrée  
Integrierte Plan-Waschtisch

L	F4		
80	TAP08001		
90	TAP09001		
100	TAP10001		
110	TAP11001		
120	TAP12001		

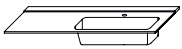

### P 54

Pianolavabo integrato  
Integrated basin  
Plan-vasque intégrée  
Integrierte Plan-Waschtisch

L	F4		
120	TAP12002		

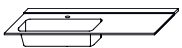

### P 54

Pianolavabo integrato  
Integrated basin  
Plan-vasque intégrée  
Integrierte Plan-Waschtisch

L	F4		
120	TAP12003		



Misure in cm  
Measures in cm  
Mesures en cm  
Maße in cm

**F1** Laccato opaco  
Matt lacquered  
Laqué mat  
Matt lackiert

**F2** Laccato lucido  
Glossy lacquered  
Laqué brillant  
Hochglanz lackiert





**F3** Nobilitati  
Veneer wood  
Placage bois  
Beschichtetes Holz

**F4** Arock®  
Arock®  
Arock®

**F5** abitat / vogue  
abitat / vogue  
abitat / vogue  
abitat / vogue

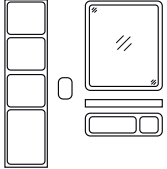
**Pianolavabo integrato**  
**Integrated basin**

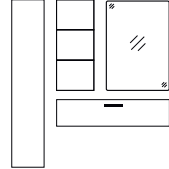
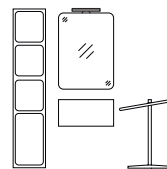
**Plan-vasque intégrée**  
**Integrierte plan-Waschtisch**

				
UNICAMENTE AROCK®	ALCENTIMETRO PROGETTO	Elementi CONTENITORI	Elementi COMPLEMENTARI	RICAMBI
34	98	180	226	592

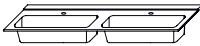
	<b>P 54</b> Pianolavabo integrato Integrated basin Plan-vasque intégrée Integrierte Plan-Waschtisch
<b>L</b> 140 TAP14004	<b>F4</b>





MOBILI DISEGNATI

**HAIKU** di T. FELDER



# H A I K U

grazie all'uso e alla duttilità di Arock®, l'esclusivo materiale di TDA resistente all'acqua, antibatterico e inalterabile nel tempo, gli stampi consentono la riproduzione industriale di questi frontali con la traccia Haiku realizzata manualmente

Haiku è un antico componimento poetico giapponese usato per raccontare "molto in poco spazio" descrivendo gli accadimenti umani nella natura

è composto da 17 sillabe secondo lo schema 5/7/5 rappresentato sui frontali di questo mobile che lo interpreta in ogni traccia

grâce à la ductilité du Arock®, le matériau exclusif TDA résistant à l'eau, antibactérien et inaltérable dans le temps, les moules permettent la reproduction industrielle de ces façades avec la trace Haiku réalisée à la main

Haiku est un ancien poème japonais utilisé pour dire "beaucoup dans un petit espace", décrivant les événements humains dans la nature

il est composé de 17 syllabes selon le schéma 5/7/5 représenté sur les façades de ce meuble



thanks to the use and adaptability of Arock®, the unique TDA's material water-resistant, antibacterial, and unalterable, the moulds enable the industrial production of front side units with Haiku trace

Haiku is an ancient poem used for narrating "a lot of things in a limited space" and describing the human events in the nature

it consists of 17 syllables based on the 5/7/5 scheme, which is depicted on the front side of our furniture and that interprets in every traces the norms of this kind of lyrical poetry

der Anpassungsfähigkeit von Arock®, dem einzigartigen Material wasserabweisend, antibakteriell, veränderlich von TDA. Seine Formen ermöglichen die industrielle Fertigung von Frontseiteneinheiten mit Haiku-Trace

Haiku ist ein uraltes Gedicht, das verwendet wird, um „viele Dinge auf begrenztem Raum“ zu erzählen und die menschlichen Ereignisse in der Natur zu beschreiben

es besteht aus 17 Silben nach dem 5/7/5-Schema, das auf der Vorderseite unserer Möbel abgebildet ist



**A** piano / top / plan / Platte

## TIPOLOGIE:

filopiano lavabo integrato;  
per lavabo sopra piano da appoggio e  
da incasso e sottopiano da incasso  
PROFONDITA': 45-51,5 cm  
FINITURE: Arock® - HPL - Nobilitato  
LEGNO/ALTATTO - Laccato OPACO/  
LUCIDO - GRES - PIETRA NATURALE -  
SILESTONE - CRISTALLO

## TYPES:

integrated plan washbasin;  
for countertop basin, recessed basin  
and undermounted basin  
DEPTH: 45-51.5 cm  
FINISHES: Arock® - HPL - Nobilitato  
LEGNO/ALTATTO - Laquered MATT/  
GLOSSY - GRES - NATURAL STONE -  
SILESTONE

## TYPOLOGIES:

lavabo intégré au plan;  
pour lavabo à poser, lavabo encastré  
surélevé et lavabo encastré  
PROFONDEUR: 45-51,5 cm  
FINITIONS: Arock® - HPL - Mé laminé  
BOIS/ALTATTO - Laque MAT/BRIL-  
LANT - GRES - PIERRE NATURELLE  
- SILESTONE

## TYPOLOGIEN:

integriertes Waschbecken;  
für Aufsatzwaschtisch, Halbeinbau-  
becken und Einbauwaschtisch  
TIEFE: 45-51,5 cm  
AUSFÜHRUNGEN: Arock® - HPL -  
Melamin HOLZ/ALTATTO - MATT/  
HOCHGLANZ Lack - GRES - NATUR-  
STEIN - SILESTONE

**B** contenitore / interior configuration / configuration intérieure / Innenausstattung

realizzato in pannelli di particelle di  
legno di spessore 16 mm, idrofughi,  
nobilitato con carta melaminica colore  
URBAN. Bordi in ABS in tinta.  
Cassetto montato su guide GRASS®  
ad estrazione totale con sponde  
laterali in metallo verniciato colore  
URBAN. Fondo e schienale nella  
finitura del contenitore  
ALTEZZA: 37-55,5 cm  
PROFONDITA': 45-51,5 cm  
LARGHEZZA: 27-36-54-63-72-81-  
90-108 cm

made of water repellent panels of 16  
mm thick wood particles, covered  
with Nobilitato URBAN color.  
Matching ABS edges  
Drawer mounted on full extension  
GRASS® runners with URBAN color  
painted metal sides. Bottom and back  
in the finish of the container  
HEIGHT: 37-55,5-74 cm  
DEPTH: 45-51,5 cm  
WIDTH: 27-36-54-63-72-81-90-  
108 cm

en panneaux hydrofuges en particules  
de bois de 16 mm d'épaisseur. Re-  
couvert de papier mélaminé couleur  
URBAN. Bords ABS de la même  
couleur  
Tiroir monté sur coulisses GRASS®  
pleine extension avec côtés en métal  
peint couleur URBAN. Fond et retour  
dans la finition du intérieur  
HAUTEUR: 37-55,5-74 cm  
PROFONDEUR: 45-51,5 cm  
LARGEUR: 27-36-54-63-72-81-90-  
108 cm

in wasserabweisenden Platten aus  
16 mm starken Holzpartikeln. Farb-  
melaminpapier und ABS Kanten der  
gleichen Farbe  
Schublade montiert auf GRASS®  
Vollauszügen mit URBAN-farbig  
lackierten Metallseiten. Boden und  
Rückseite im Abgang des Behälters  
HÖHE: 37-55,5-74 cm  
TIEFE: 45-51,5 cm  
BREITE: 27-36-54-63-72-81-90-108  
cm

**C** frontali / front panels / tiroirs / Schublade

realizzati in Arock®  
SPESSORE: 1,8 cm  
FINITURE: 48 colori.02

made of Arock®  
THICKNESS: 1,8 cm  
FINISHES: 48 colori.02

en Arock®  
ÉPAISSEUR: 1,8 cm  
FINITIONS: 48 colori.02

aus Arock®  
DICKE: 1,8 cm  
OBERFLÄCHEN: 48 colori.02

**D** apertura / opening system / système d'ouverture / Öffnungssystem

fascia maniglia in alluminio verniciato

painted alu. handle-profile

profil poignée en aluminium laqué

Griffprofil aus lackiertem Aluminium

**E** pannelli terminali / terminal panles / panneaux lateraux / seitliche Panele

## OBBLIGATORI

realizzati in pannelli di particelle di  
legno  
SPESSORE: 1 cm  
FINITURE: Laccato OPACO/LUCIDO in  
48 colori.02

## REQUIRED

made of water repellent panels of  
wood particles  
THICKNESS: 1 cm  
FINISHES: MATT/GLOSSY Lacquered  
48 colori.02

## OBLIGATOIRE

panneaux hydrofuges en particules  
de bois  
ÉPAISSEUR: 1 cm  
FINITIONS: Laqué MAT/BRILLANT en  
48 colori.02

## NÖTIG

aus wasserabweisenden Spanplatten,  
veredelt mit Melaminpapier  
DICKE: 1 cm  
OBERFLÄCHEN: MATT/HOCHGLANZ  
Lack aus 48 colori.02

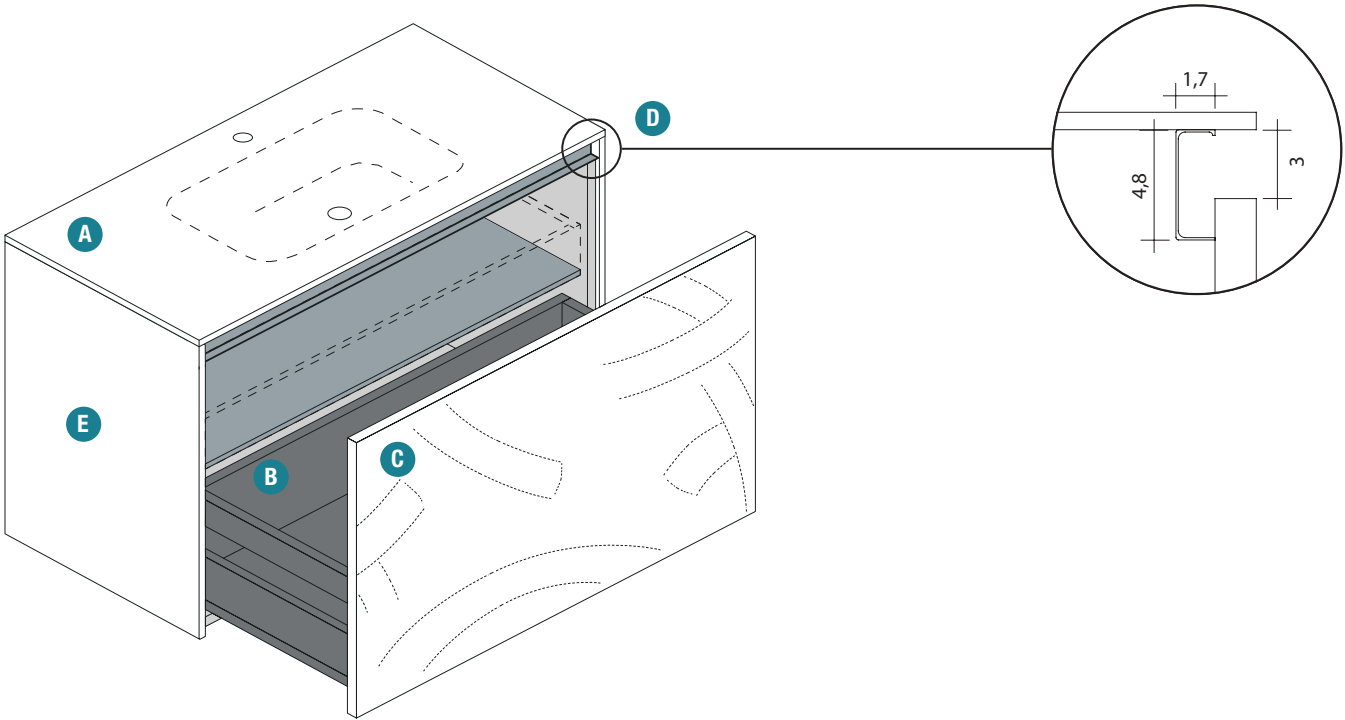



frontale Arock® / mobile laccato OPACO  
front Arock® / unit MATT lacquered

frontal en Arock® / meubles laqué MAT  
Front in Arock® / Möbel MATT lackiert

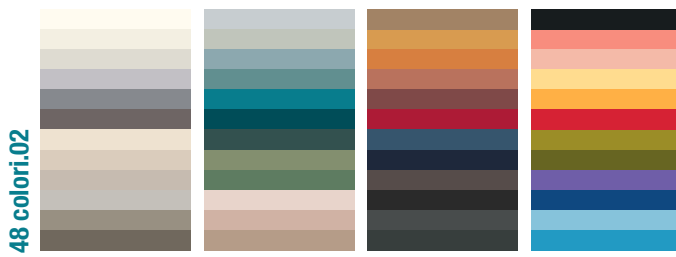

**Fascia maniglia**

**Handle profile**

**Profil poignée**

**Griffprofil**

FINITURE:

. laccato OPACO 48 **colori.02**  
. extra pag. 592

FINISHES:

. MATT lacquered 48 **colori.02**  
. extra pag. 592

FINITIONS:

. laqué MAT 48 **colori.02**  
. extra pag. 592

OBERFLÄCHEN:

. MATT lackiert 48 **colori.02**  
. extra pag. 592



ALLUMINIO

UNICAMENTE

AROCK®

ALCENTIMETRO

PROGETTO

## piani / tops / plans / \Platten



piano e piano d'arredo  
top for interior  
plan pour l'ameublement  
Platte fuer Einrichtung

piano e piano d'arredo accoppiato  
coated  
accouplé  
verdoppelt

## lavabo / basin / vasque / Becken

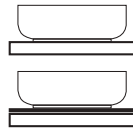

soprapiano da appoggio  
countertop basin  
lavabo à poser  
Aufsetzbecken

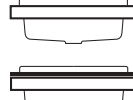

soprapiano da incasso  
recessed basin  
lavabo encastré surélevé  
Halbeinbaubecken



sottopiano da incasso  
undermounted basin  
lavabo en profondeur  
Untereinbaubecken



lavabo integrato  
integrated basin  
vasque intégrée  
integriertes Becken

	SP cm	P 45 cm	P 51,5 cm	
<b>AROCK®</b>	1,2 / 6			
<b>Laccato OPACO / LUCIDO</b>	1,8			
<b>Nobilitato LEGNO / ALTATTO</b>	1,8			
<b>Nobilitato LEGNO / ALTATTO + GRES</b> <b>Laccato OPACO / LUCIDO + GRES</b>	2,4			
<b>HPL</b>	1			
<b>GRES</b>	0,6 / 1,2 1,2			
<b>CRISTALLO extrachiaro verniciato</b> <b>extra-clear lacquered GLASS</b> <b>VERRE lacquée extraclair</b> <b>Hochglanz lackierte GLAS</b>	1,2			
<b>PIETRA NATURALE</b> <b>NATURAL STONE</b> <b>PIERRE NATURELLE</b> <b>NATURSTEIN</b>	2			
<b>SILESTONE</b>	1,2			



**Modularità**  
**Modularity**

**Modularité**  
**Modularität**

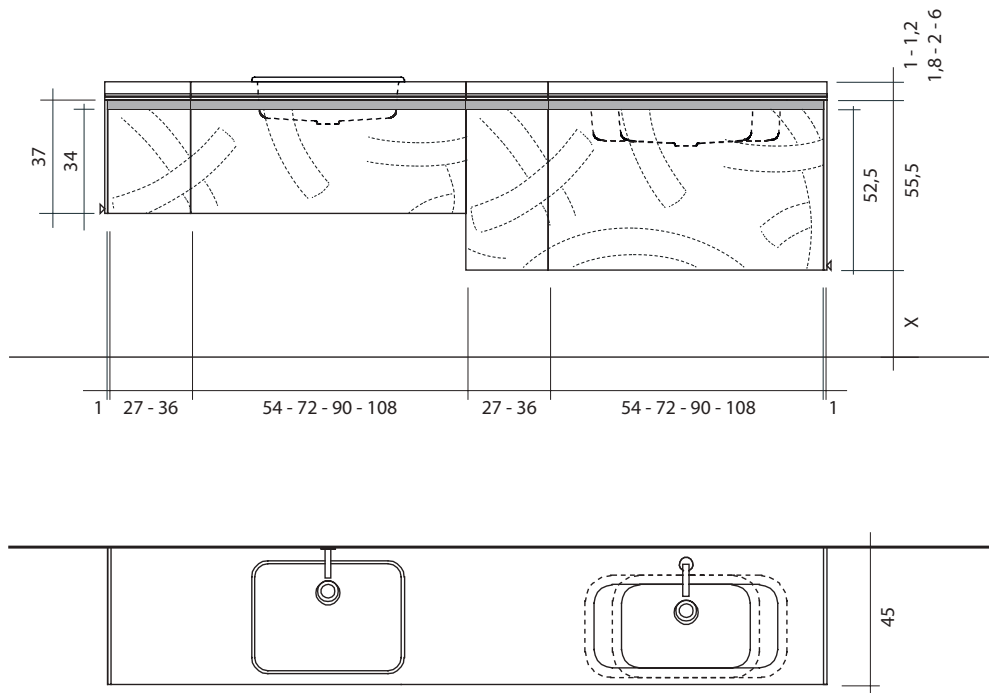

**basi portlavabo**  
**vanity units**  
**meubles sous-vasque**  
**Waschtischunterschranke**

L 54-63-72-81-90-108 cm

**basi laterali**  
**side units**  
**meubles bas latéraux**  
**Unterschranke**

L 27-36-54-63-72-81-90-108 cm

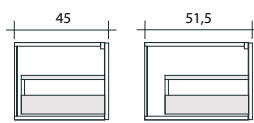
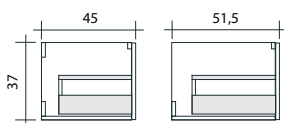

frontale unico estraibile con cassetto, chiusura ammortizzata  
single pull-out, soft-closing  
façade amovible avec tiroir  
ein Schublade

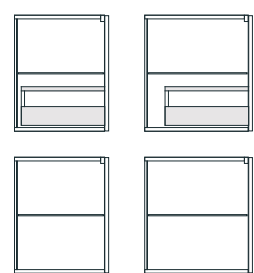
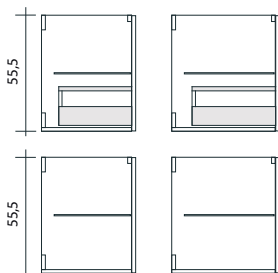

frontale unico estraibile con cassetto chiusura ammortizzata + 1 ripiano  
single pull-out, soft-closing + 1 shelf  
façade amovible avec tiroir + 1 étagère  
ein Schublade + 1 Regal

1 anta o 2 ante chiusura ammortizzata + 1 ripiano  
single door or double door, soft-closing + 1 shelf  
1 porte ou 2 portes + 1 étagère  
1 Tür oder 2 Türen + 1 Regal

**Modularità HAIKU**  
Modularity HAIKU

**Modularité HAIKU**  
Modularität HAIKU

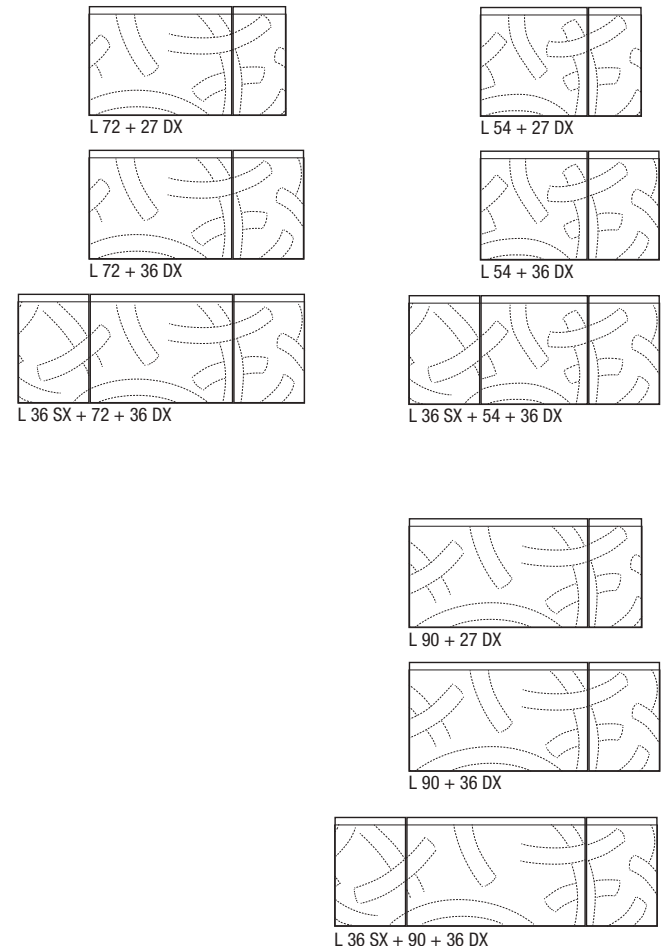
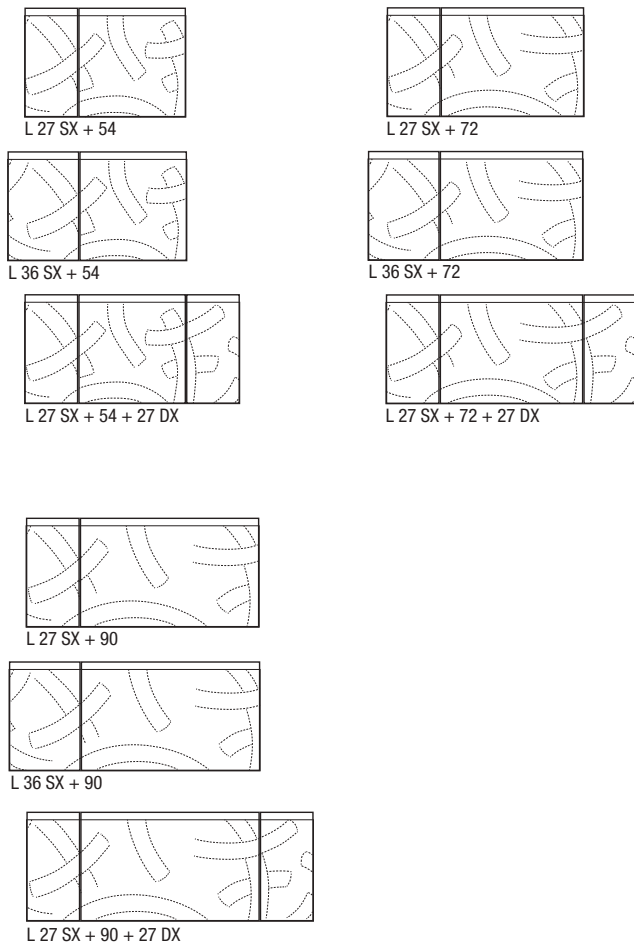
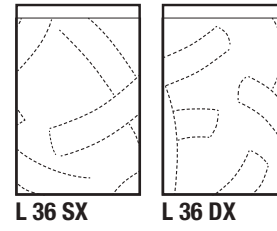
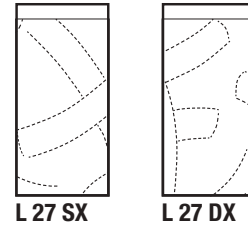
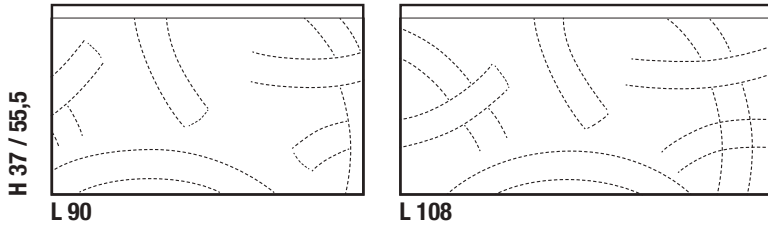
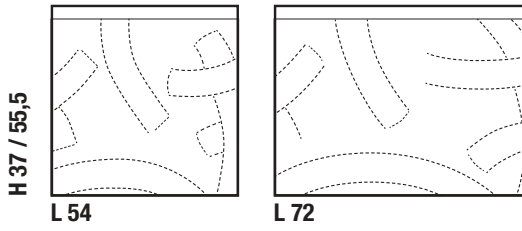



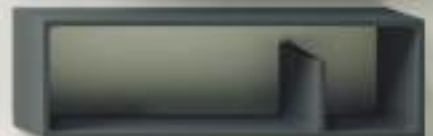
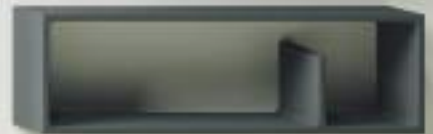
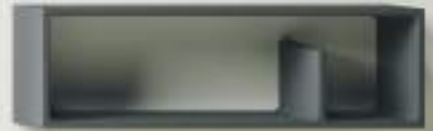



## Pannelli terminali obbligatori

### Required terminal panels

## Paneaux de finition latéral obligatoires

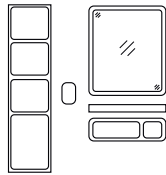
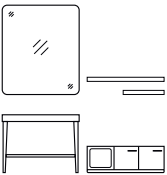
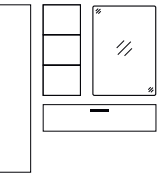
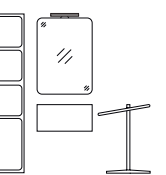
### Nötig terminal Panele

				
UNICAMENTE AROCK®	ALCENTIMETRO PROGETTO	Elementi CONTENTORI	Elementi COMPLEMENTARI	RICAMBI
34	98	180	226	592

#### H 37

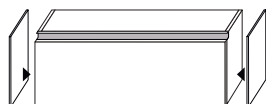

#### P 45

Pannelli terminali - OBBLIGATORI  
Terminal panels - REQUIRED  
Panueaux de finition latéral - OBLIGATOIRES  
Terminal Panele - NÖTIG

L	F1	F2	F3
1 GGUFIN10			

#### P 51,5

L	F1	F2	F3
1 GGUFIN40			

#### H 55,5

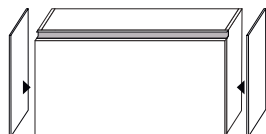

#### P 45

Pannelli terminali - OBBLIGATORI  
Terminal panels - REQUIRED  
Panueaux de finition latéral - OBLIGATOIRES  
Terminal Panele - NÖTIG

L	F1	F2	F3
1 GGUFIN15			

#### P 51,5

L	F1	F2	F3
1 GGUFIN45			



Misure in cm  
Measures in cm  
Mesures en cm  
Maße in cm

**F1** Laccato opaco  
Matt lacquered  
Laqué mat  
Matt lackiert

**F2** Laccato lucido  
Glossy lacquered  
Laqué brillant  
Hochglanz lackiert





**F3** Nobilitati  
Veneer wood  
Placage bois  
Beschichtetes Holz

**F4** Arock®  
Arock®  
Arock®

**F5** abitat / vogue  
abitat / vogue  
abitat / vogue  
abitat / vogue

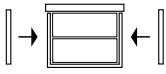
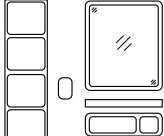
## Basi Units

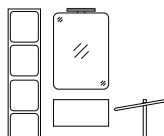
## Meubles bas Unterschränke

					
Terminale di finitura OBBLIGATORIO	UNICAMENTE AROCK®	ALCENTIMETRO PROGETTO	Elementi CONTENITORI	Elementi COMPLEMENTARI	RICAMBI
334	34	98	180	226	592

### H 37

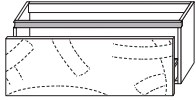

### P 45

Base portlavabo • 1 cassetto chiusura ammortizzata • sifone incl.  
Vanity unit • 1 soft-closing pull-out • siphon incl.  
Meuble sous vasque • 1 tiroir amorti • siphon incl.  
Waschtischunterschrank • 1 Soft-Closing Schublade • Siphon inkl.

L		F4		
54	GGL05454			
72	GGL07254			
90	GGL09054			
108	GGL10854			

### P 51,5

L		F4		
54	GGM05454			
72	GGM07254			
90	GGM09054			
108	GGM10854			

### H 37

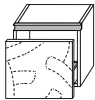

### P 45

Base laterale dx • 1 cassetto chiusura ammortizzata  
Side unit • 1 right soft-closing pull-out  
Meuble bas latéral droite • 1 tiroir amorti  
Seitenschrank-rechts • 1 Soft-Closing Schublade

L		F4		
27	GGG02754			
36	GGG03654			

### P 51,5

L		F4		
27	GGJ02754			
36	GGJ03654			

### H 37

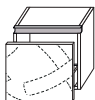

### P 45

Base laterale sx • 1 cassetto chiusura ammortizzata  
Side unit • 1 left soft-closing pull-out  
Meuble bas latéral gauche • 1 tiroir amorti  
Seitenschrank-links • 1 Soft-Closing Schublade

L		F4		
27	GGG02755			
36	GGG03655			

### P 51,5

L		F4		
27	GGJ02755			
36	GGJ03655			

  
 Misure in cm  
 Measures in cm  
 Mesures en cm  
 Maße in cm

**F1** Laccato opaco  
 Matt lacquered  
 Laqué mat  
 Matt lackiert

**F2** Laccato lucido  
 Glossy lacquered  
 Laqué brillant  
 Hochglanz lackiert

**F3** Nobilitati  
 Veneer wood  
 Placage bois  
 Beschichtetes Holz

**F4** Arock®  
 Arock®  
 Arock®  
 Arock®

**F5** abitat / vogue  
 abitat / vogue  
 abitat / vogue  
 abitat / vogue

# Basi Units

# Meubles bas Unterschränke

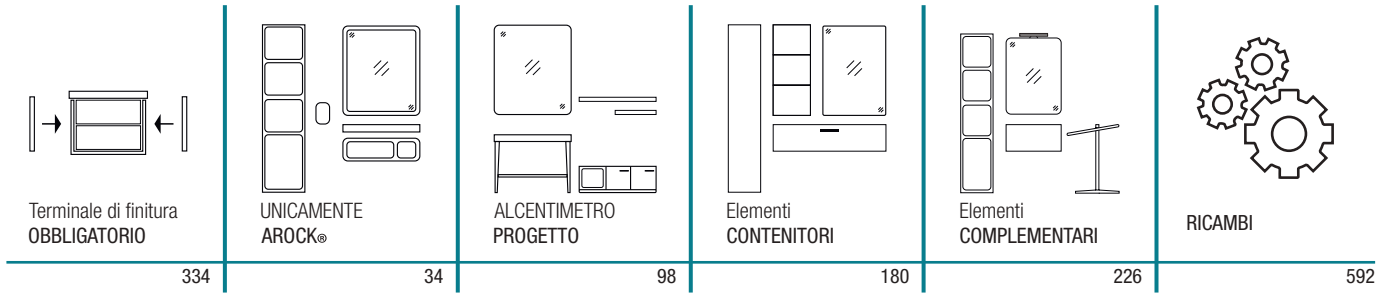

## H 55,5

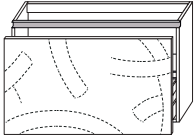

## P 45

Base portalavabo • 1 cassetto chiusura ammortizzata + 1 ripiano • sifone incl.  
 Vanity unit • 1 soft-closing pull-out + 1 shelf • siphon incl.  
 Meuble sous vasque • 1 tiroir amorti + 1 étagère • siphon incl.  
 Waschtischunterschrank • 1 Soft-Closing Schublade + 1 Regal • Siphon inkl.

L		F4		
54	GGL05456			
72	GGL07256			
90	GGL09056			
108	GGL10856			

## P 51,5

L		F4		
54	GGM05456			
72	GGM07256			
90	GGM09056			
108	GGM10856			

## H 55,5

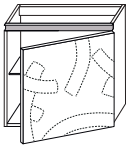

## P 45

Base portalavabo dx • 1 anta chiusura ammortizzata + 1 ripiano • sifone incl.  
 Vanity unit • 1 right soft-closing door + 1 shelf • siphon incl.  
 Meuble sous vasque droite • 1 porte amorti + 1 étagère • siphon incl.  
 Waschtischunterschrank-rechts • 1 Tür + 1 Regal • Siphon inkl.

L		F4		
54	GGL05460			

## P 51,5

L		F4		
54	GGM05460			

## H 55,5

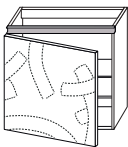

## P 45

Base portalavabo sx • 1 anta chiusura ammortizzata + 1 ripiano • sifone incl.  
 Vanity unit • 1 left soft-closing door + 1 shelf • siphon incl.  
 Meuble sous vasque gauche • 1 porte amorti + 1 étagère • siphon incl.  
 Waschtischunterschrank-links • 1 Tür + 1 Regal • Siphon inkl.

L		F4		
54	GGL05461			

## P 51,5

L		F4		
54	GGM05461			



Misure in cm  
 Measures in cm  
 Mesures en cm  
 Maße in cm

**F1** Laccato opaco  
 Matt lacquered  
 Laqué mat  
 Matt lackiert

**F2** Laccato lucido  
 Glossy lacquered  
 Laqué brillant  
 Hochglanz lackiert

**F3** Nobilitati  
 Veneer wood  
 Placage bois  
 Beschichtetes Holz





**F4** Arock®  
 Arock®  
 Arock®  
 Arock®

**F5** abitat / vogue  
 abitat / vogue  
 abitat / vogue  
 abitat / vogue

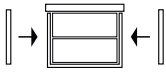
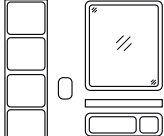

## Basi Units

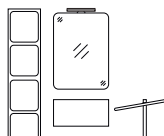
## Meubles bas Unterschränke

					
Terminale di finitura OBBLIGATORIO	UNICAMENTE AROCK®	ALCENTIMETRO PROGETTO	Elementi CONTENITORI	Elementi COMPLEMENTARI	RICAMBI
334	34	98	180	226	592

### H 55,5

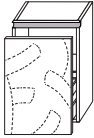

### P 45

Base laterale dx • 1 cassetto chiusura ammortizzata + 1 ripiano  
Side unit • 1 right soft-closing pull-out + 1 shelf  
Meuble bas latéral droite • 1 porte amorti + 1 étagère  
Seitenschrank-rechts • 1 Soft-Closing Schublade + 1 Regal

L	F4		
27	GGG02756		
36	GGG03656		

### P 51,5

L	F4		
27	GGJ02756		
36	GGJ03656		

### H 55,5

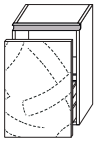

### P 45

Base laterale sx • 1 cassetto chiusura ammortizzata + 1 ripiano  
Side unit • 1 left soft-closing pull-out + 1 shelf  
Meuble bas latéral gauche • 1 porte amorti + 1 étagère  
Seitenschrank-links • 1 Soft-Closing Schublade + 1 Regal

L	F4		
27	GGG02757		
36	GGG03657		

### P 51,5

L	F4		
27	GGJ02757		
36	GGJ03657		

### H 55,5

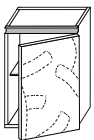

### P 45

Base laterale dx • 1 anta chiusura ammortizzata + 1 ripiano  
Side unit • 1 right soft-closing door + 1 shelf  
Meuble bas latéral droite • 1 porte amorti + 1 étagère  
Seitenschrank-rechts • 1 Tür + 1 Regal

L	F4		
27	GGB02760		
36	GGB03660		

### P 51,5

L	F4		
27	GGD02760		
36	GGD03660		

  
 Misure in cm  
 Measures in cm  
 Mesures en cm  
 Maße in cm

**F1** Laccato opaco  
 Matt lacquered  
 Laqué mat  
 Matt lackiert

**F2** Laccato lucido  
 Glossy lacquered  
 Laqué brillant  
 Hochglanz lackiert



**F3** Nobilitati  
 Veneer wood  
 Placage bois  
 Beschichtetes Holz

**F4** Arock®  
 Arock®  
 Arock®  
 Arock®

**F5** abitat / vogue  
 abitat / vogue  
 abitat / vogue  
 abitat / vogue

## Basi Units

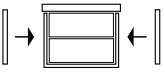
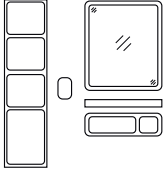
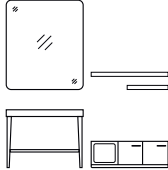
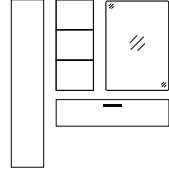
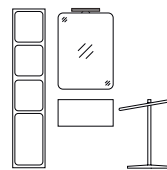
## Meubles bas Unterschranke

					
Terminale di finitura OBBLIGATORIO	UNICAMENTE AROCK®	ALCENTIMETRO PROGETTO	Elementi CONTENTORI	Elementi COMPLEMENTARI	RICAMBI
334	34	98	180	226	592

### H 55,5

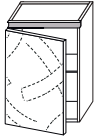

### P 45

Base laterale sx • 1 anta chiusura ammortizzata + 1 ripiano  
Side unit • 1 left soft-closing door + 1 shelf  
Meuble bas latéral gauche • 1 porte amorti + 1 étagère  
Seitenschrank-links • 1 Tür + 1 Regal

L	F4		
27	GGB02761		
36	GGB03661		

### P 51,5

L	F4		
27	GGD02761		
36	GGD03661		



Misure in cm  
Measures in cm  
Mesures en cm  
Maße in cm

**F1** Laccato opaco  
Matt lacquered  
Laqué mat  
Matt lackiert

**F2** Laccato lucido  
Glossy lacquered  
Laqué brillant  
Hochglanz lackiert

**F3** Nobilitati  
Veneer wood  
Placage bois  
Beschichtetes Holz

**F4** Arock®  
Arock®  
Arock®  
Arock®

**F5** abitat / vogue  
abitat / vogue  
abitat / vogue  
abitat / vogue



*Shizuka sa ya  
iwa ni shimi iru  
semi no koe*

*Il silenzio  
penetra nella roccia  
un canto di cicale*

*(Haiku di Bashō)*



MOBILI COMPATTI

**ONESTO**



# O N E S T O

è un mobile compatto. Un corpo solido con struttura uniforme e armoniosa. L'intima coesione fra le parti componenti definisce un equilibrato valore tecnico economico



il est un meuble compact. Un corps solide avec une structure uniforme et harmonieuse. La cohésion intime entre les composants définit une valeur esthétique, technique et économique équilibrée

it is a compact piece of furniture. A solid base with a consistent and harmonious structure. The intimate cohesion among the component parts defines a balanced aesthetic, technical, and economic value



es ist ein kompaktes Möbelstück. Ein fester Körper mit einer einheitlichen und harmonischen Struktur. Der Zusammenhalt der Komponenten definiert einen ausgewogenen technischen und wirtschaftlichen Wert



**A filopiano lavabo integrato / integrated plan washbasin / vasque en plan intégrée / integrierte Waschtischplatte**

<b>FINITURE:</b> CERAMICA 1,5 cm bianco opaco/lucido & 4 colori opaco CASTMARBLE 1,2 cm bianco opaco/lucido & 48 colori.02 PROFONDITÀ: 46,5-51,5 cm	<b>FINISHES:</b> CERAMIC 1,5 cm matt/glossy white & 4 matt colors CASTMARBLE 1,2 cm matt/glossy white & 48 colori.02 DEPTH: 46,5-51,5 cm	<b>FINITIONS:</b> CÉRAMIQUE 1,5 cm blanc mat/brillant & 4 couleurs mat CASTMARBLE 1,2 cm blanc mat/brillant & 48 colori.02 PROFONDEUR: 46,5-51,5 cm	<b>OBERFLÄCHEN:</b> KERAMIK weiß matt/glänzend & 4 matt Farbe CASTMARBLE weiß matt/glänzend & 48 colori.02 TIEFE: 46,5-51,5 cm
--	---	--	---

**B contenitore / interior configuration / configuration intérieure / Innenausstattung**

realizzato in pannelli di particelle di legno di spessore 18 mm, idrofughi, nobilitato con carta melaminica colore URBAN. Bordi in ABS in tinta. Cassetto montato su guide GRASS® ad estrazione totale con sponde laterali in metallo verniciato colore URBAN. Fondo e schienale nella finitura del contenitore ALTEZZA: 50 cm PROFONDITÀ: 46,5-51,5 cm LARGHEZZA: 60-70-80-90-105-120-140 cm	made of water repellent panels of 18 mm thick wood particles, covered with Nobilitato URBAN color. Matching ABS edges Drawer mounted on full extension GRASS® runners with URBAN color painted metal sides. Bottom and back in the finish of the container HEIGHT: 50 cm DEPTH: 46,5-51,5 cm WIDTH: 60-70-80-90-105-120-140 cm	en panneaux hydrofuges en particules de bois de 18 mm d'épaisseur. Recouvert de papier mélaminé couleur URBAN. Bords ABS de la même couleur Tiroir monté sur coulisses GRASS® pleine extension avec côtés en métal peint couleur URBAN. Fond et retour dans la finition du intérieur HAUTEUR: 50 cm PROFONDEUR: 46,5-51,5 cm LARGEUR: 60-70-80-90-105-120-140 cm	in wasserabweisenden Platten aus 18 mm starken Holzpartikeln. Farb-melaminpapier und ABS Kanten der gleichen Farbe Schublade montiert auf GRASS® Vollauszügen mit URBAN-farbig lackierten Metallseiten. Boden und Rückseite im Abgang des Behälters HÖHE: 50 cm TIEFE: 46,5-51,5 cm BREITE: 60-70-80-90-105-120-140 cm
---	--	--	--

**C frontale / front panel / tiroir / Schublade**

realizzato in pannelli di particelle di legno idrofugo nobilitato con carta melaminica SPESSORE: 1,8 cm FINITURE: Laccato OPACO/LUCIDO 48 colori.02 - Nobilitato LEGNO	made of water repellent panels of wood particles THICKNESS: 1,8 cm FINISHES: MATT/GLOSSY Lacquered 48 colori.02 - Nobilitato LEGNO	en panneaux hydrofuges en particules de bois recouvert de papier mélaminé ÉPAISSEUR: 1,8 cm FINITIONS: Laqué MAT/BRILLANT en 48 colori.02 - Nobilitato LEGNO	aus wasserabweisenden Spanplatten, veredelt mit Melaminpapier DICKE: 1,8 cm OBERFLÄCHEN: MATT/HOCHGLANZ Lack aus 48 colori.02 - Nobilitato LEGNO
--	--	--	--

**D apertura / opening system / système d'ouverture / Öffnungssystem**

Maniglia FILO / Maniglia PONTE / Smusso 45° / Sistema Premi-Apri	FILO Handle / PONTE Handle / Smusso 45° / Premi-Apri System	Poignée FILO / Poignée PONTE / Smusso 45° / Système Premi-Apri	FILO Griff / PONTE Griff / Smusso 45° / Premi-Apri System
--	---	--	---

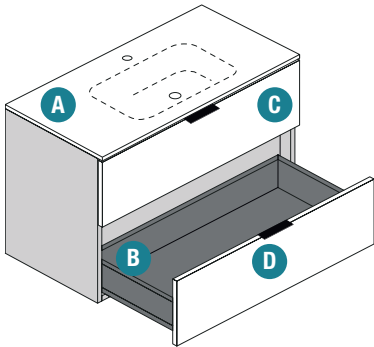

**Maniglia FILO**  
**FILO Handle**  
**Poignée FILO**  
**FILO Griff**

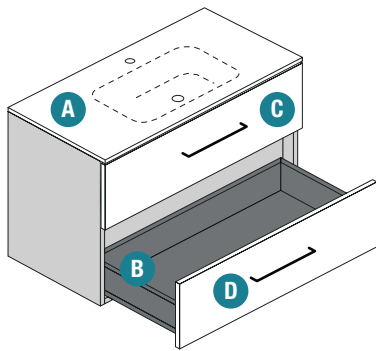

**Maniglia PONTE**  
**PONTE Handle**  
**Poignée PONTE**  
**PONTE Griff**

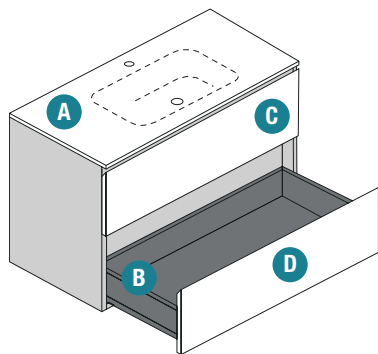

**Smusso 45°**

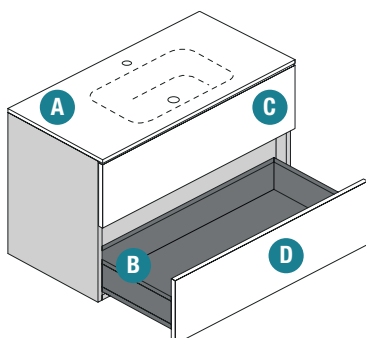

**Sistema Premi-Apri**  
**Premi-Apri System**  
**Système Premi-Apri**  
**Premi-Apri System**



**Nobilitato LEGNO**

pannello di particelle di legno spessore 18 mm idrofugo a basso contenuto di formaldeide nobilitato interno ed esterno con carta melaminica in finitura LEGNO riprodotto ad alta fedeltà; bordo in ABS in finitura

high pressure layered laminate, a perfect and strong imitation of the natural wooden surface

stratifiés décoratifs haute pression. Plaques à base de résines thermoscurcissables appelées stratifiés

Hochdruckmehrschichtlaminat mit einer dreidimensionalen Erscheinung

**laccato OPACO / LUCIDO  
MATT / GLOSSY lacquered**

pannello di particelle di legno, idrofugo, a basso contenuto di formaldeide, verniciato con resine poliuretaniche pigmentate opache o lucide

wood particles panel 18 mm with low formaldehyde content, painted with polyurethane resins

**laqué MAT / BRILLANT  
MATT / HOCHGLANZ lackiert**

panneaux de particules de bois 18 mm à faible teneur en formaldéhyde, peint avec des résines de polyuréthane

Holzpartikelplatte 18 mm mit niedrigem Formaldehydgehalt, mit Polyurethanharzen lackiert

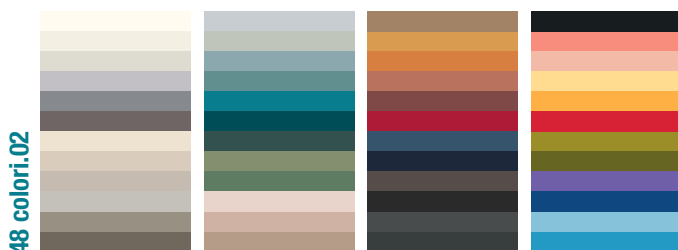

**Maniglia PONTE - L 20 cm****FINITURE:**

. laccato OPACO 48 colori.02  
. extra pag. 592



CROMO OPACO



TITANIO



ORO OPACO SATINATO

**PONTE Handle - L 20 cm****FINISHES:**

. MATT lacquered 48 colori.02  
. extra pag. 592

**Poignée PONTE - L 20 cm****FINITIONS:**

. laqué MAT 48 colori.02  
. extra pag. 592

**PONTE Griff - L 20 cm****OBERFLÄCHEN:**

. MATT lackiert 48 colori.02  
. extra pag. 592

**Maniglia FILO - L 20 cm****FINITURE:**

. laccato OPACO 48 colori.02

**FILO Handle - L 20 cm****FINISHES:**

. MATT lacquered 48 colori.02

**Poignée FILO - L 20 cm****FINITIONS:**

. laqué MAT 48 colori.02

**FILO Griff - L 20 cm****OBERFLÄCHEN:**

. MATT lackiert 48 colori.02

**abbinamento consigliato mobile/maniglia**  
**combinations furniture/handle**

mobile Nobilitato LEGNO

	12W ABETE BIANCO
	14W ABETE BROWN
	26W ABETE ROCCIA
	27W ABETE FONDENTE
	31W FRONDA PURO
	32W FRONDA LIEVE
	33W FRONDA NUDO
	34W FRONDA ARCANO



maniglia laccato OPACO

	01 NUDE
	0H CURCUMA
	05 WILD
	0U MOCHA
	01 NUDE
	0G EARTH
	03 NATURE
	59 NERO

**coordinations meuble/poignée**  
**Griffeabstimmung**





CERAMICA  
CERAMIC

CÉRAMIQUE  
KERAMIK

Filopiano lavabo integrato  
Integrated plan washbasin  
Vasque en plan intégrée  
Integrierte Waschtischplatte

51,5



46,5



SX / DX



foro rubinetto incl.  
tap hole incl.  
trou pour le robinet incl.  
Armaturbohrung inkl.

provisto di scarico troppopieno  
with overflow system  
avec système de trop-plein  
mit Überlaufsystem

kit piletta e sifone da ordinare separatamente  
waste kit and siphon to be ordered separately  
kit bonde d'évacuation et siphon à commander séparément  
Ablauf Kit und Siphon müssen separat bestellt werden



materiale inorganico non metallico composto da argilla, caolino, feldspato, quarzo, molto duttile allo stato naturale, rigido dopo la fase di cottura. Lo smalto bianco o colorato oltre allo scopo estetico rende impermeabile la massa ceramica

inorganic material composed of clay, kaolin, feldspar and quartz. In addition to the aesthetic purpose, the white or colored glaze makes the ceramic mass waterproof

matériau inorganique non métallique d'argile, de kaolin, de feldspath et quartz. En plus de sa fonction esthétique, le vernis blanc ou coloré rend la masse céramique imperméable

anorganisches nichtmetallisches Material, aus Ton, Kaolin, Feldspat und Quarz. Neben dem ästhetischen Zweck macht die weiße oder farbige Glasur die Keramikmasse wasserdicht

lavabo integrato  
integrated washbasin  
vasque intégrée  
integriertes Becken



CERBIA

BIANCO LUCIDO

CERC02

POLVERE OPACO

CERC03

CRETA OPACO

CERC04

MALTA OPACO

CERC05

ANTRACITE OPACO

CERBIO

BIANCO OPACO

colore CERAMICA

cartella colori.02

 CERC02 POLVERE OPACO

 02 ROYAL

 CERC03 CRETA OPACO

 03 NATURE

 CERC04 MALTA OPACO

 0F ROMAN

 CERC05 ANTRACITE OPACO

 16 DEEP GREY

i colori qui riportati sono da considerarsi indicativi  
the colours can diverge from the reality  
la fidélité des couleurs peut être différent de la réalité  
bitte berücksichtigen Sie unsere Farbfächer zur Farbauswahl

TOLLERANZA LARGHEZZA E PROFONDITÀ

Misura nominale	Tolleranza in larghezza	Tolleranza sulla P 51,5	Tolleranza sulla P 45
da 61 a 81 cm	+ 6 / - 5 mm	+ 4 / - 2mm	+ 5 / - 3 mm
91 cm	+ 7 / - 5 mm	+ 4 / - 2mm	+ 5 / - 3 mm
da 106 a 141 cm	+ 10 / - 6 mm	+ 4 / - 2mm	+ 6 / - 3 mm

TOLLERANZA DEFORMAZIONE DEI BORDI

Larghezza lavabo	Valore della tolleranza
< = 90 cm	max 3 mm
> 90 cm < 125 cm	max 4 mm
> = 125 cm	max 5 mm

TOLLERANZA PIEGATURA DEI BORDI

Larghezza lavabo	Valore della tolleranza
< = 90 cm	± 1,5 mm
> 90 cm < 125 cm	± 2,5 mm
> = 125 cm	± 4 mm

TOLLERANZA SPESSORE DEL LAVABO

< = 25 mm	max 3 mm
> 25 mm < 50 mm	max 4 mm

## CASTMARBLE

Filopiano lavabo integrato  
 Integrated plan washbasin  
 Vasque en plan intégrée  
 Integrierte Waschtischplatte



foro rubinetto incl.  
 tap hole incl.  
 trou pour le robinet incl.  
 Armaturbohrung inkl.

provisto di scarico troppopieno  
 with overflow system  
 avec système de trop-plein  
 mit Überlaufsystem

kit piletta e sifone da ordinare separatamente  
 waste kit and siphon to be ordered separately  
 kit bonde d'évacuation et siphon à commander séparément  
 Ablauf Kit und Siphon müssen separat bestellt werden

materiale composito costituito da carbonato di calcio, magnesio e resina poliestere. La finitura superficiale e l'assenza di giunzioni lo rende resistente

special material composed of carbonates, magnesium and polyhedral resins. The surface finish and the absence of joints makes it resistant

matériau spécial composé de alumine et résine acrylique. La finition de surface et l'absence de joints le rendent résistant

Spezialwerkstoff aus Aluminiumoxid und Acrylharz. Die Oberflächenbeschaffenheit und das Fehlen von Gelenken macht es resistent



BIANCO OPACO



BIANCO LUCIDO

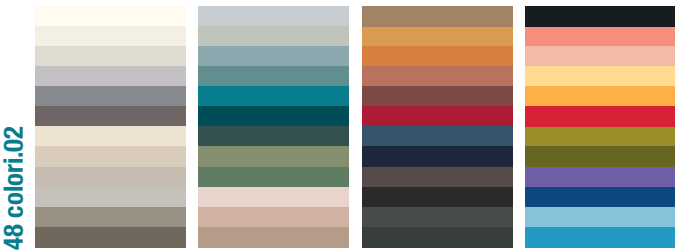

i colori qui riportati sono da considerarsi indicativi  
the colours can diverge from the reality  
la fidélité des couleurs peut être différent de la réalité  
bitte berücksichtigen Sie unsere Farbfächer zur Farbauswahl

**P 46,5 - H 1,5 cm**

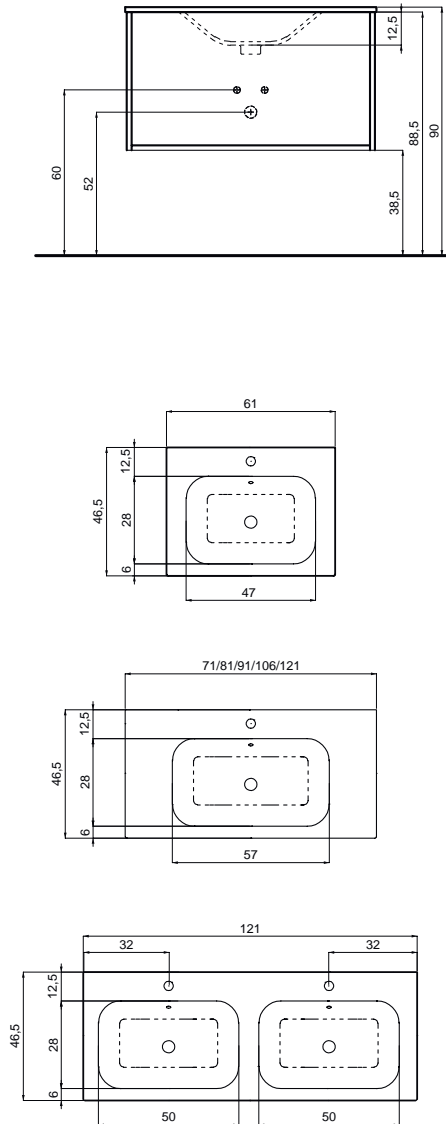

**P 51,5 - H 1,5 cm**

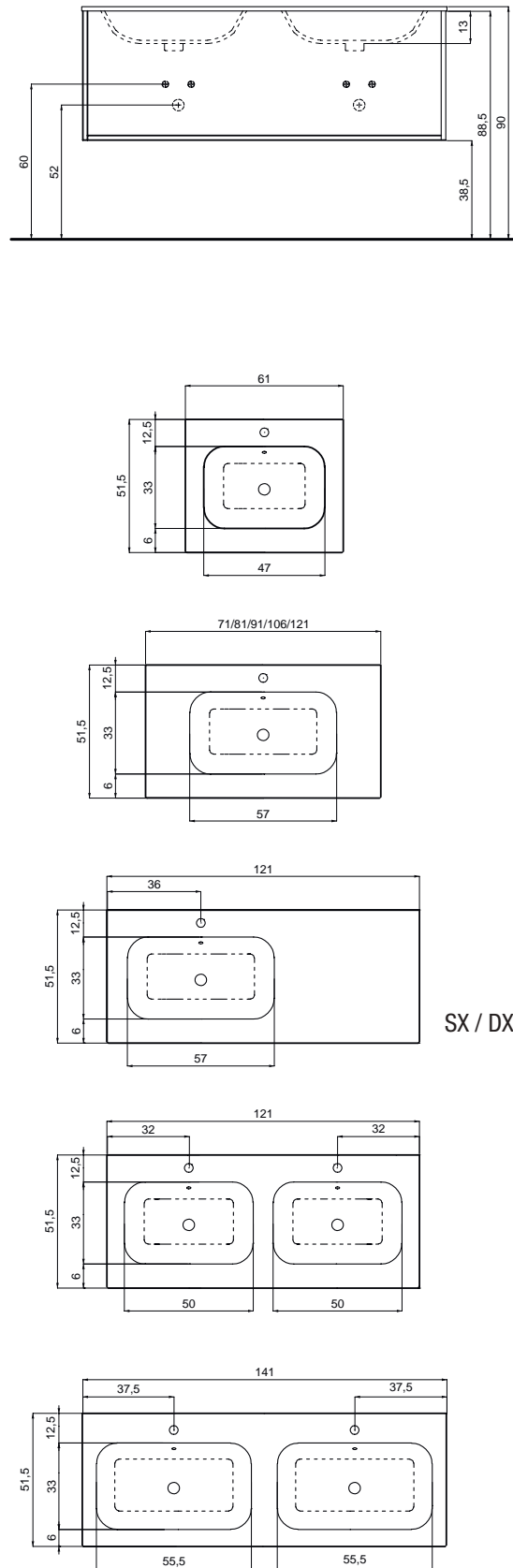

SX / DX

**P 46 - H 1,2 cm**

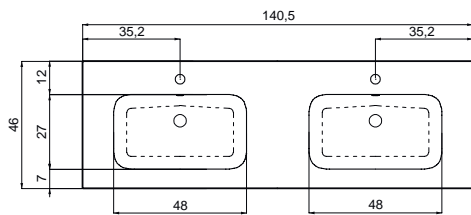
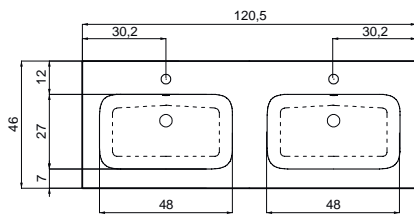
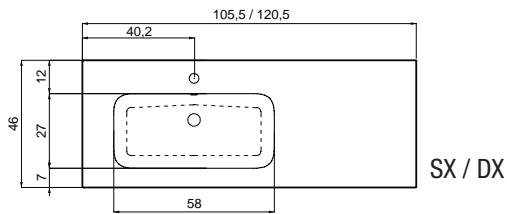
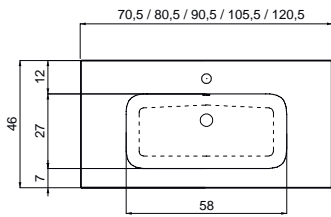
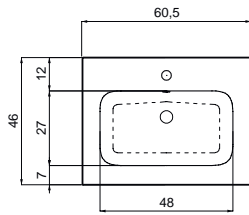
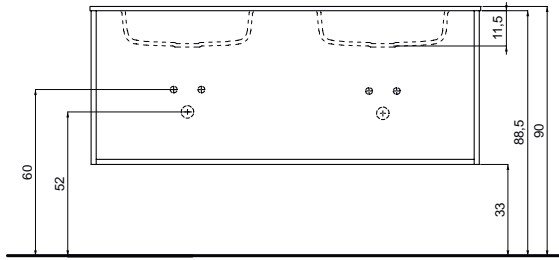

**P 51,5 - H 1,2 cm**

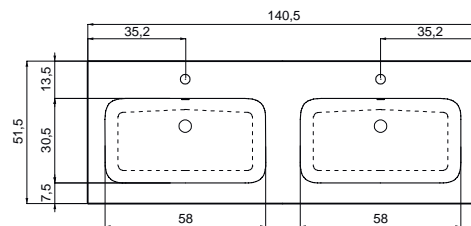
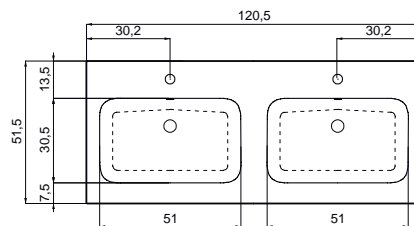
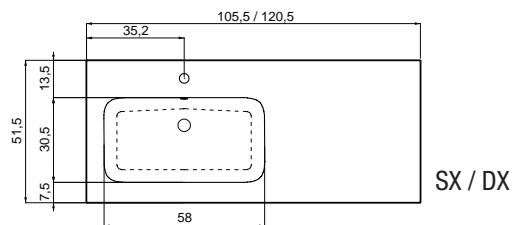
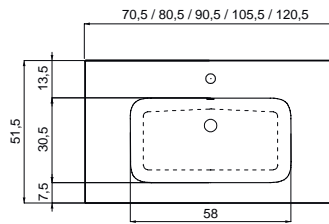
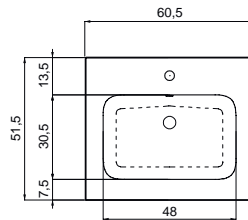
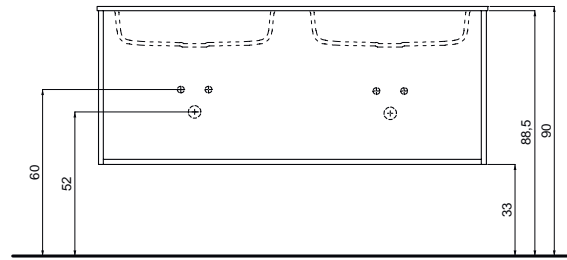





Modularità  
Modularity

Modularité  
Modularität

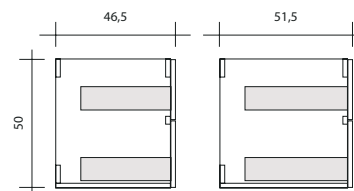
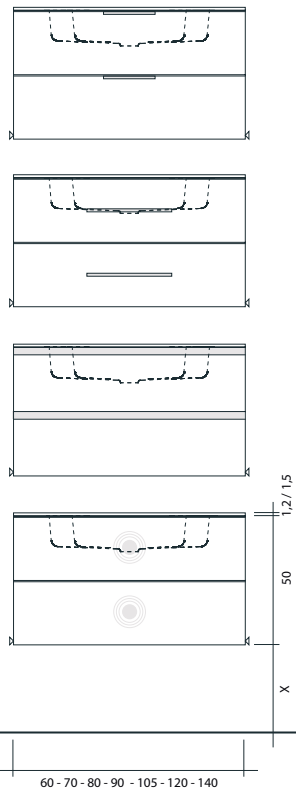

doppio frontale estraibile con cassetto, chiusura ammortizzata  
double soft-closing pull-out  
2 tiroirs amortis  
2 Schubladen

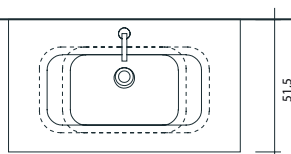
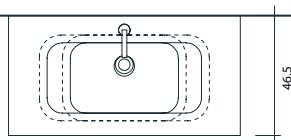



Parte tecnica  
 Technical section

P 46,5 - P 51,5 cm

Section technique  
 Technischer Teil

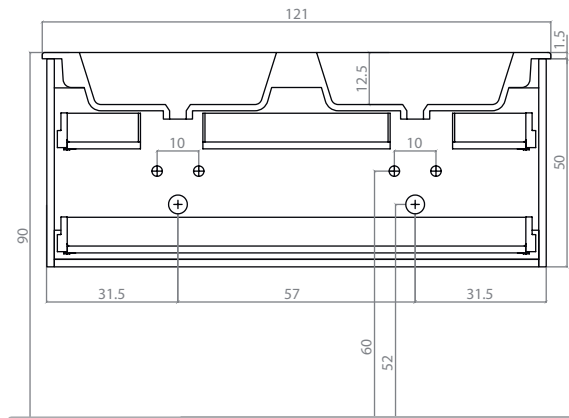
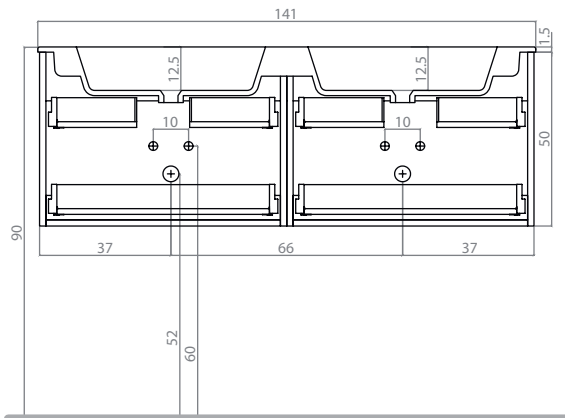
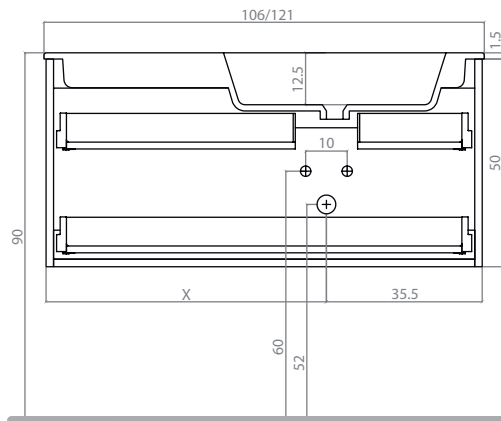
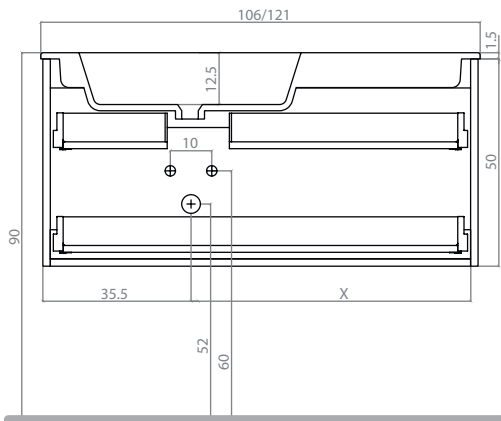
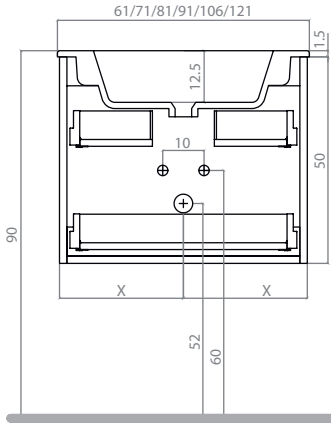

**Maniglia FILO**



**Maniglia PONTE**



**Smusso 45°**



**Sistema Premi-Apri**



## Basi con pianolavabo integrato Vanity units with basin

## Meubles avec plan-vasque Waschtischunterschranke

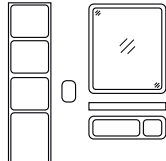

UNICAMENTE  
AROCK®

34



ALCENTIMETRO  
PROGETTO

98

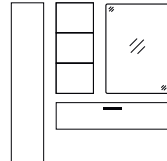

Elementi  
CONTENITORI

180

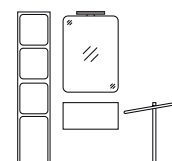

Elementi  
COMPLEMENTARI

226



RICAMBI

592

### H 50

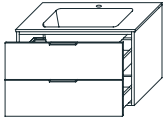

### P 46,5

Maniglia FILO & chiusura ammortizzata • ceramica bianco lucido lavabo centrale • 2 cassettei • sifone incl.  
FILO Handle & soft-closing • vanity unit 2 pull-out & ceramic white gloss basin set • siphon incl.  
Poignée FILO & fermeture amortie • meuble avec plan-vasque en céramique blanc brillant • 2 tiroirs • siphon incl.  
FILO Griff • Waschtischunterschrank inkl. 2 Soft-Closing Schubladen & Keramik weiß Hochglanz Waschtisch • Siphon inkl.

L		F1	F2	F3
60	MN2060CA			
70	MN2070CA			
80	MN2080CA			
90	MN2090CA			
105	MN2105CA			
120	MN2120CA			

### P 51,5

L		F1	F2	F3
60	MN2060CC			
70	MN2070CC			
80	MN2080CC			
90	MN2090CC			
105	MN2105CC			
120	MN2120CC			

### H 50

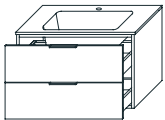

### P 46,5

Maniglia FILO & chiusura ammortizzata • ceramica colore opaco lavabo centrale • 2 cassettei • sifone incl.  
FILO Handle & soft-closing • vanity unit 2 pull-out & ceramic color matt basin set • siphon incl.  
Poignée FILO & fermeture amortie • meuble avec plan-vasque en céramique colour mat • 2 tiroirs • siphon incl.  
FILO Griff • Waschtischunterschrank inkl. 2 Soft-Closing Schubladen & Keramik Matt Farbe Waschtisch • Siphon inkl.

L		F1	F2	F3
60	MN2060CB			
70	MN2070CB			
80	MN2080CB			
90	MN2090CB			
105	MN2105CB			

### P 51,5

L		F1	F2	F3
60	MN2060CD			
70	MN2070CD			
80	MN2080CD			
90	MN2090CD			
105	MN2105CD			
120	MN2120CD			

### H 50

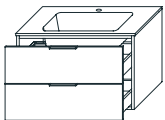

### P 46,5

Maniglia FILO & chiusura ammortizzata • Castmarble bianco opaco/lucido lavabo centrale • 2 cassettei • sifone incl.  
FILO Handle & soft-closing • vanity unit 2 pull-out & Castmarble white matt/gloss basin set • siphon incl.  
Poignée FILO & fermeture amortie • meuble avec plan-vasque en Castmarble blanc mat/brillant • 2 tiroirs • siphon incl.  
FILO Griff • Waschtischunterschrank inkl. 2 Soft-Closing Schubladen & Castmarble weiß Matt/Hochglanz Waschtisch • Siphon inkl.

L		F1	F2	F3
60	MN2060CM			
70	MN2070CM			
80	MN2080CM			
90	MN2090CM			
105	MN2105CM			
120	MN2120CM			

### P 51,5

L		F1	F2	F3
60	MN2060CN			
70	MN2070CN			
80	MN2080CN			
90	MN2090CN			
105	MN2105CN			
120	MN2120CN			

H  
L  
P

Misure in cm  
Measures in cm  
Mesures en cm  
Maße in cm

**F1** Laccato opaco  
Matt lacquered  
Laqué mat  
Matt lackiert

**F2** Laccato lucido  
Glossy lacquered  
Laqué brillant  
Hochglanz lackiert

**F3** Nobilitati  
Veneer wood  
Placage bois  
Beschichtetes Holz

**F4** Arock®  
Arock®  
Arock®  
Arock®

**F5** abitat / vogue  
abitat / vogue  
abitat / vogue  
abitat / vogue

## Basi con pianolavabo integrato Vanity units with basin

## Meubles avec plan-vasque Waschtischunterschranke

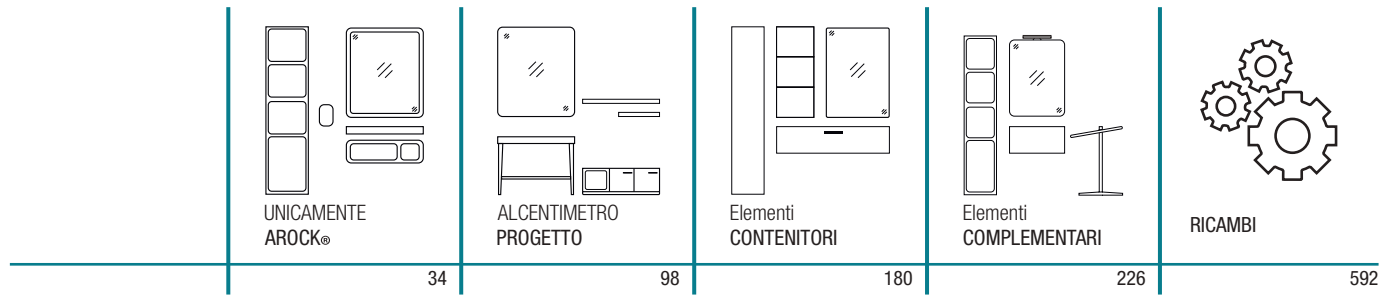

### H 50

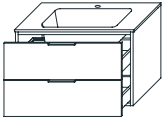

### P 46,5

Maniglia FILO & chiusura ammortizzata • Castmarble Colori.02 lavabo centrale • 2 cassetti • sifone incl.  
FILO Handle & soft-closing • vanity unit 2 pull-out & Castmarble Colori.02 basin set • siphon incl.  
Poignée FILO & fermeture amortie • meuble avec plan-vasque en Castmarble Colori.02 • 2 tiroirs • siphon incl.  
FILO Griff • Waschtischunterschrank inkl. 2 Soft-Closing Schubladen & Castmarble Colori.02 Waschtisch • Siphon inkl.

L		F1	F2	F3
60	MN2060CP			
70	MN2070CP			
80	MN2080CP			
90	MN2090CP			
105	MN2105CP			
120	MN2120CP			

### P 51,5

L		F1	F2	F3
60	MN2060CR			
70	MN2070CR			
80	MN2080CR			
90	MN2090CR			
105	MN2105CR			
120	MN2120CR			

### H 50

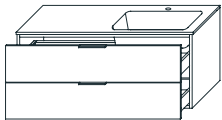

### P 51,5

Maniglia FILO & chiusura ammortizzata • ceramica bianco lucido lavabo dx • 2 cassetti • sifone incl.  
FILO Handle & soft-closing • vanity unit 2 pull-out & ceramic white gloss basin set • siphon incl.  
Poignée FILO & fermeture amortie • meuble avec plan-vasque en céramique blanc brillant • 2 tiroirs • siphon incl.  
FILO Griff • Waschtischunterschrank inkl. 2 Soft-Closing Schubladen & Keramik weiß Hochglanz Waschtisch • Siphon inkl.

L		F1	F2	F3
105	MN2105DC			
120	MN2120DC			

### H 50

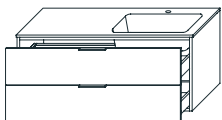

### P 51,5

Maniglia FILO & chiusura ammortizzata • ceramica colore opaco lavabo dx • 2 cassetti • sifone incl.  
FILO Handle & soft-closing • vanity unit 2 pull-out & ceramic color matt basin set • siphon incl.  
Poignée FILO & fermeture amortie • meuble avec plan-vasque en céramique colour mat • 2 tiroirs • siphon incl.  
FILO Griff • Waschtischunterschrank inkl. 2 Soft-Closing Schubladen & Keramik Matt Farbe Waschtisch • Siphon inkl.

L		F1	F2	F3
105	MN2105DD			
120	MN2120DD			

H  
L  
P

Misure in cm  
Measures in cm  
Mesures en cm  
Maße in cm

**F1** Laccato opaco  
Matt lacquered  
Laqué mat  
Matt lackiert

**F2** Laccato lucido  
Glossy lacquered  
Laqué brillant  
Hochglanz lackiert

**F3** Nobilitati  
Veneer wood  
Placage bois  
Beschichtetes Holz

**F4** Arock®  
Arock®  
Arock®  
Arock®

**F5** abitat / vogue  
abitat / vogue  
abitat / vogue  
abitat / vogue

## Basi con pianolavabo integrato Vanity units with basin

## Meubles avec plan-vasque Waschtischunterschranke

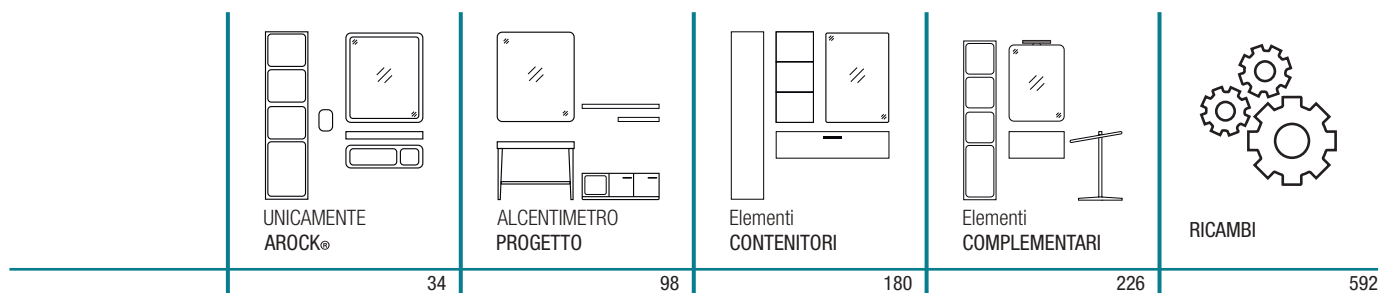

### H 50

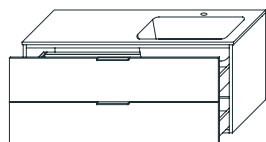

### P 46,5

Maniglia FILO & chiusura ammortizzata • Castmarble bianco opaco/lucido lavabo dx • 2 cassetti • sifone incl.  
FILO Handle & soft-closing • vanity unit 2 pull-out & Castmarble white matt/gloss basin set • siphon incl.  
Poignée FILO & fermeture amortie • meuble avec plan-vasque en Castmarble blanc mat/brillant • 2 tiroirs • siphon incl.  
FILO Griff • Waschtischunterschrank inkl. 2 Soft-Closing Schubladen & Castmarble weiß Matt/Hochglanz Waschtisch • Siphon inkl.

L		F1	F2	F3
105	MN2105DM			
120	MN2120DM			

### P 51,5

L		F1	F2	F3
105	MN2105DN			
120	MN2120DN			

### H 50

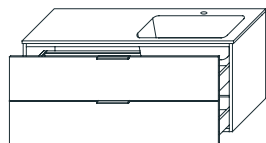

### P 46,5

Maniglia FILO & chiusura ammortizzata • Castmarble Colori.02 lavabo dx • 2 cassetti • sifone incl.  
FILO Handle & soft-closing • vanity unit 2 pull-out & Castmarble Colori.02 basin set • siphon incl.  
Poignée FILO & fermeture amortie • meuble avec plan-vasque en Castmarble Colori.02 • 2 tiroirs • siphon incl.  
FILO Griff • Waschtischunterschrank inkl. 2 Soft-Closing Schubladen & Castmarble Colori.02 Waschtisch • Siphon inkl.

L		F1	F2	F3
105	MN2105DP			
120	MN2120DP			

### P 51,5

L		F1	F2	F3
105	MN2105DR			
120	MN2120DR			

### H 50

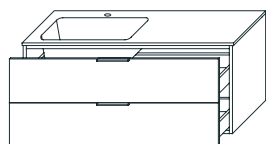

### P 51,5

Maniglia FILO & chiusura ammortizzata • ceramica bianco lucido lavabo sx • 2 cassetti • sifone incl.  
FILO Handle & soft-closing • vanity unit 2 pull-out & ceramic white gloss basin set • siphon incl.  
Poignée FILO & fermeture amortie • meuble avec plan-vasque en céramique blanc brillant • 2 tiroirs • siphon incl.  
FILO Griff • Waschtischunterschrank inkl. 2 Soft-Closing Schubladen & Keramik weiß Hochglanz Waschtisch • Siphon inkl.

L		F1	F2	F3
105	MN2105SC			
120	MN2120SC			

H  
L  
P

Misure in cm  
Measures in cm  
Mesures en cm  
Maße in cm

**F1** Laccato opaco  
Matt lacquered  
Laqué mat  
Matt lackiert

**F2** Laccato lucido  
Glossy lacquered  
Laqué brillant  
Hochglanz lackiert

**F3** Nobilitati  
Veneer wood  
Placage bois  
Beschichtetes Holz

**F4** Arock®  
Arock®  
Arock®  
Arock®

**F5** abitat / vogue  
abitat / vogue  
abitat / vogue  
abitat / vogue

## Basi con pianolavabo integrato Vanity units with basin

## Meubles avec plan-vasque Waschtischunterschranke

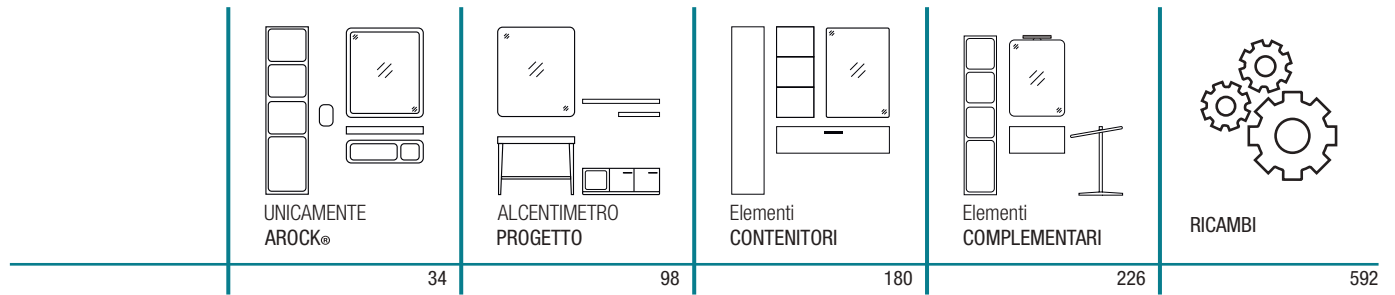

### H 50

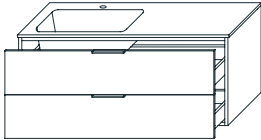

Maniglia FILO & chiusura ammortizzata • ceramica colore opaco lavabo sx • 2 cassetti • sifone incl.  
 FILO Handle & soft-closing • vanity unit 2 pull-out & ceramic color matt basin set • siphon incl.  
 Poignée FILO & fermeture amortie • meuble avec plan-vasque en céramique colour mat • 2 tiroirs • siphon incl.  
 FILO Griff • Waschtischunterschrank inkl. 2 Soft-Closing Schubladen & Keramik Matt Farbe Waschtisch • Siphon inkl.

### P 51,5

L	F1	F2	F3
105 MN2105SD			
120 MN2120SD			

### H 50

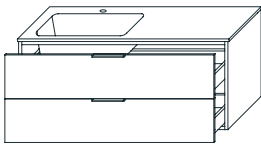

### P 46,5

Maniglia FILO & chiusura ammortizzata • Castmarble bianco opaco/lucido lavabo sx • 2 cassetti • sifone incl.  
 FILO Handle & soft-closing • vanity unit 2 pull-out & Castmarble white matt/gloss basin set • siphon incl.  
 Poignée FILO & fermeture amortie • meuble avec plan-vasque en Castmarble blanc mat/brillant • 2 tiroirs • siphon incl.  
 FILO Griff • Waschtischunterschrank inkl. 2 Soft-Closing Schubladen & Castmarble weiß Matt/Hochglanz Waschtisch • Siphon inkl.

### P 51,5

L	F1	F2	F3
105 MN2105SM			
120 MN2120SM			

L	F1	F2	F3
105 MN2105SN			
120 MN2120SN			

### H 50

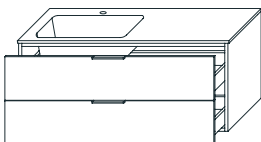

### P 46,5

Maniglia FILO & chiusura ammortizzata • Castmarble Colori.02 lavabo sx • 2 cassetti • sifone incl.  
 FILO Handle & soft-closing • vanity unit 2 pull-out & Castmarble Colori.02 basin set • siphon incl.  
 Poignée FILO & fermeture amortie • meuble avec plan-vasque en Castmarble Colori.02 • 2 tiroirs • siphon incl.  
 FILO Griff • Waschtischunterschrank inkl. 2 Soft-Closing Schubladen & Castmarble Colori.02 Waschtisch • Siphon inkl.

### P 51,5

L	F1	F2	F3
105 MN2105SP			
120 MN2120SP			

L	F1	F2	F3
105 MN2105SR			
120 MN2120SR			

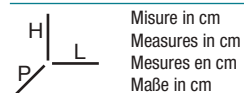

Misure in cm  
 Measures in cm  
 Mesures en cm  
 Maße in cm

**F1** Laccato opaco  
 Matt lacquered  
 Laqué mat  
 Matt lackiert

**F2** Laccato lucido  
 Glossy lacquered  
 Laqué brillant  
 Hochglanz lackiert

**F3** Nobilitati  
 Veneer wood  
 Placage bois  
 Beschichtetes Holz

**F4** Arock®  
 Arock®  
 Arock®  
 Arock®

**F5** abitat / vogue  
 abitat / vogue  
 abitat / vogue  
 abitat / vogue

# Basi con pianolavabo integrato Vanity units with basin

# Meubles avec plan-vasque Waschtischunterschranke

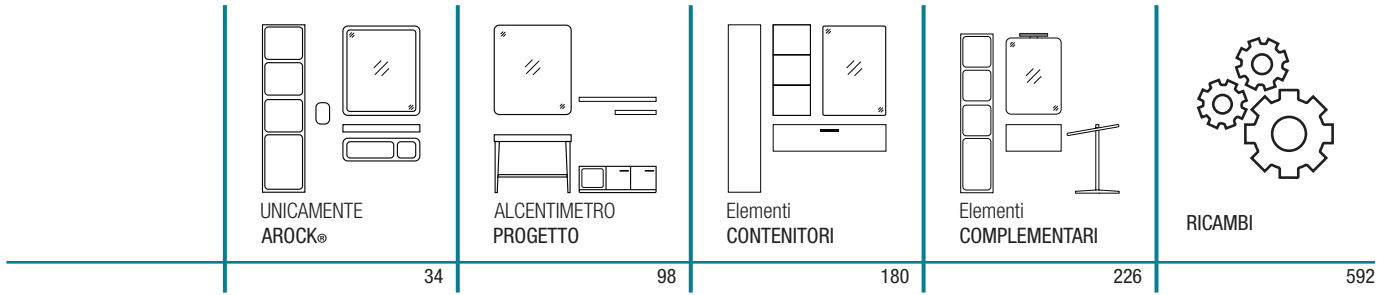

UNICAMENTE  
AROCK®

ALCENTIMETRO  
PROGETTO

Elementi  
CONTENITORI

Elementi  
COMPLEMENTARI

RICAMBI

34

98

180

226

592

## H 50

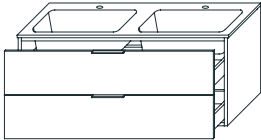

### P 46,5

Maniglia FILO & chiusura ammortizzata • ceramica bianco lucido lavabo doppio • 2 cassette • sifone incl.  
FILO Handle & soft-closing • vanity unit 2 pull-out & ceramic white gloss basin set • siphon incl.  
Poignée FILO & fermeture amortie • meuble avec plan-vasque en céramique blanc brillant • 2 tiroirs • siphon incl.  
FILO Griff • Waschtischunterschrank inkl. 2 Soft-Closing Schubladen & Keramik weiß Hochglanz Waschtisch • Siphon inkl.

L	F1	F2	F3
120 MN2120TA			

### P 51,5

L	F1	F2	F3
120 MN2120TC			

## H 50

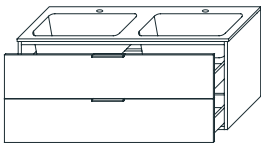

### P 51,5

Maniglia FILO & chiusura ammortizzata • ceramica colore opaco lavabo doppio • 2 cassette • sifone incl.  
FILO Handle & soft-closing • vanity unit 2 pull-out & ceramic color matt basin set • siphon incl.  
Poignée FILO & fermeture amortie • meuble avec plan-vasque en céramique colour mat • 2 tiroirs • siphon incl.  
FILO Griff • Waschtischunterschrank inkl. 2 Soft-Closing Schubladen & Keramik Matt Farbe Waschtisch • Siphon inkl.

L	F1	F2	F3
120 MN2120TD			

## H 50

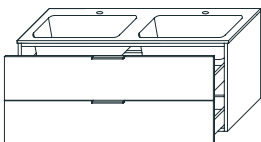

### P 46,5

Maniglia FILO & chiusura ammortizzata • Castmarble bianco opaco/lucido lavabo doppio • 2 cassette • sifone incl.  
FILO Handle & soft-closing • vanity unit 2 pull-out & Castmarble white matt/gloss basin set • siphon incl.  
Poignée FILO & fermeture amortie • meuble avec plan-vasque en Castmarble blanc mat/brillant • 2 tiroirs • siphon incl.  
FILO Griff • Waschtischunterschrank inkl. 2 Soft-Closing Schubladen & Castmarble weiß Matt/Hochglanz Waschtisch • Siphon inkl.

L	F1	F2	F3
120 MN2120TM			

### P 51,5

L	F1	F2	F3
120 MN2120TN			



Misure in cm  
Measures in cm  
Mesures en cm  
Maße in cm

**F1** Laccato opaco  
Matt lacquered  
Laqué mat  
Matt lackiert

**F2** Laccato lucido  
Glossy lacquered  
Laqué brillant  
Hochglanz lackiert

**F3** Nobilitati  
Veneer wood  
Placage bois  
Beschichtetes Holz





**F4** Arock®  
Arock®  
Arock®  
Arock®

**F5** abitat / vogue  
abitat / vogue  
abitat / vogue  
abitat / vogue

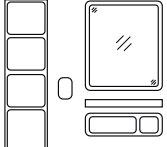

## Basi con pianolavabo integrato Vanity units with basin

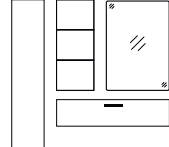
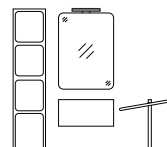
## Meubles avec plan-vasque Waschtischunterschranke

				
UNICAMENTE AROCK®	ALCENTIMETRO PROGETTO	Elementi CONTENITORI	Elementi COMPLEMENTARI	RICAMBI
34	98	180	226	592

### H 50

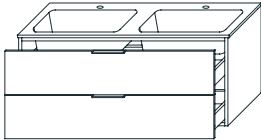

### P 46,5

Maniglia FILO & chiusura ammortizzata • Castmarble Colori.02 lavabo doppio • 2 cassetti • sifone incl.  
FILO Handle & soft-closing • vanity unit 2 pull-out & Castmarble Colori.02 basin set • siphon incl.  
Poignée FILO & fermeture amortie • meuble avec plan-vasque en Castmarble Colori.02 • 2 tiroirs • siphon incl.  
FILO Griff • Waschtischunterschrank inkl. 2 Soft-Closing Schubladen & Castmarble Colori.02 Waschtisch • Siphon inkl.

L 120 MN2120TP

F1

F2

F3

### P 51,5

L 120 MN2120TR

F1

F2

F3

### H 50

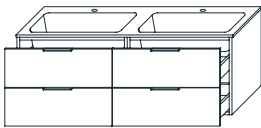

### P 51,5

Maniglia FILO & chiusura ammortizzata • ceramica bianco lucido lavabo doppio • 4 cassetti • sifone incl.  
FILO Handle & soft-closing • vanity unit 4 pull-out & ceramic white gloss basin set • siphon incl.  
Poignée FILO & fermeture amortie • meuble avec plan-vasque en céramique blanc brillant • 4 tiroirs • siphon incl.  
FILO Griff • Waschtischunterschrank inkl. 4 Soft-Closing Schubladen & Keramik weiß Hochglanz Waschtisch • Siphon inkl.

L 140 MN2140TC

F1

F2

F3

### H 50

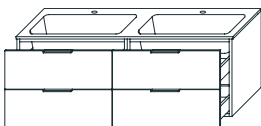

### P 51,5

Maniglia FILO & chiusura ammortizzata • ceramica colore opaco lavabo doppio • 4 cassetti • sifone incl.  
FILO Handle & soft-closing • vanity unit 4 pull-out & ceramic color matt basin set • siphon incl.  
Poignée FILO & fermeture amortie • meuble avec plan-vasque en céramique colour mat • 4 tiroirs • siphon incl.  
FILO Griff • Waschtischunterschrank inkl. 4 Soft-Closing Schubladen & Keramik Matt Farbe Waschtisch • Siphon inkl.

L 140 MN2140TD

F1

F2

F3

H  
L  
P

Misure in cm  
Measures in cm  
Mesures en cm  
Maße in cm

**F1** Laccato opaco  
Matt lacquered  
Laqué mat  
Matt lackiert

**F2** Laccato lucido  
Glossy lacquered  
Laqué brillant  
Hochglanz lackiert

**F3** Nobilitati  
Veneer wood  
Placage bois  
Beschichtetes Holz

**F4** Arock®  
Arock®  
Arock®  
Arock®

**F5** abitat / vogue  
abibat / vogue  
abibat / vogue  
abibat / vogue







ONESTO maniglia FILO base L 120 P 46,5 laccato opaco & castmarble Colori.02 1337 euro  
specchio illuminazione LED integrata L 105 H 90 460 euro  
vano a giorno orizzontale L 70 H 25 P 18 140 euro

## Basi con pianolavabo integrato Vanity units with basin

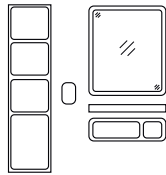
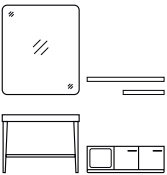
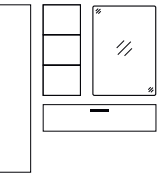
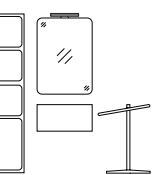
## Meubles avec plan-vasque Waschtischunterschranke

				
UNICAMENTE AROCK®	ALCENTIMETRO PROGETTO	Elementi CONTENTORI	Elementi COMPLEMENTARI	RICAMBI
34	98	180	226	592

### H 50

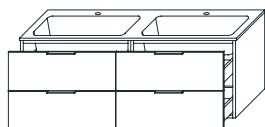

### P 46,5

Maniglia FILO & chiusura ammortizzata • Castmarble bianco opaco/lucido lavabo doppio • 4 cassetti • sifone incl.  
FILO Handle & soft-closing • vanity unit 4 pull-out & Castmarble white matt/gloss basin set • siphon incl.  
Poignée FILO & fermeture amortie • meuble avec plan-vasque en Castmarble blanc mat/brillant • 4 tiroirs • siphon incl.  
FILO Griff • Waschtischunterschrank inkl. 4 Soft-Closing Schubladen & Castmarble weiß Matt/Hochglanz Waschtisch • Siphon inkl.

L 140 MN2140TM

F1

F2

F3

### P 51,5

L 140 MN2140TN

F1

F2

F3

### H 50

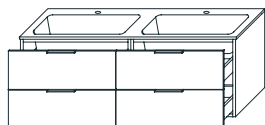

### P 46,5

Maniglia FILO & chiusura ammortizzata • Castmarble Colori.02 lavabo doppio • 4 cassetti • sifone incl.  
FILO Handle & soft-closing • vanity unit 4 pull-out & Castmarble Colori.02 basin set • siphon incl.  
Poignée FILO & fermeture amortie • meuble avec plan-vasque en Castmarble Colori.02 • 4 tiroirs • siphon incl.  
FILO Griff • Waschtischunterschrank inkl. 4 Soft-Closing Schubladen & Castmarble Colori.02 Waschtisch • Siphon inkl.

L 140 MN2140TP

F1

F2

F3

### P 51,5

L 140 MN2140TR

F1

F2

F3



Misure in cm  
Measures in cm  
Mesures en cm  
Maße in cm

**F1** Laccato opaco  
Matt lacquered  
Laqué mat  
Matt lackiert

**F2** Laccato lucido  
Glossy lacquered  
Laqué brillant  
Hochglanz lackiert

**F3** Nobilitati  
Veneer wood  
Placage bois  
Beschichtetes Holz

**F4** Arock®  
Arock®  
Arock®  
Arock®

**F5** abitat / vogue  
abitat / vogue  
abitat / vogue  
abitat / vogue

## Basi con pianolavabo integrato Vanity units with basin

## Meubles avec plan-vasque Waschtischunterschranke

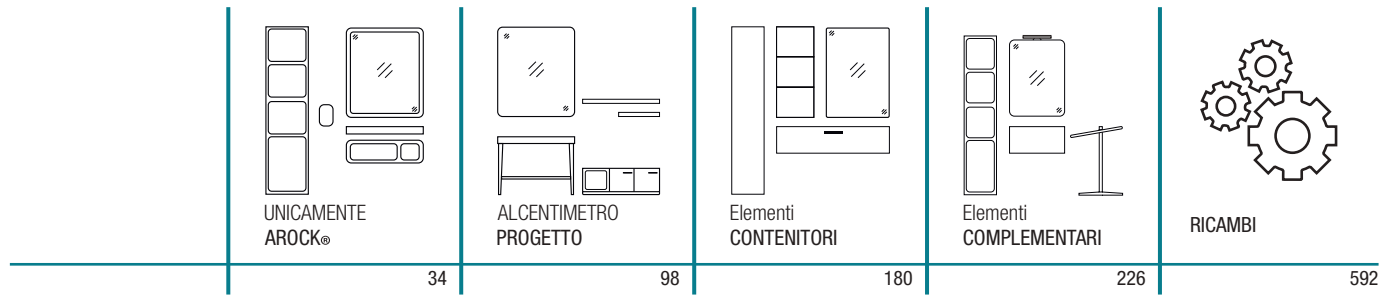

### H 50

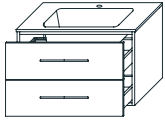

### P 46,5

Maniglia PONTE & chiusura ammortizzata • ceramica bianco lucido lavabo centrale • 2 cassetti • sifone incl.  
 PONTE Handle & soft-closing • vanity unit 2 pull-out & ceramic white gloss basin set • siphon incl.  
 Poignée PONTE & fermeture amortie • meuble avec plan-vasque en céramique blanc brillant • 2 tiroirs • siphon incl.  
 PONTE Griff • Waschtischunterschrank inkl. 2 Soft-Closing Schubladen & Keramik weiß Hochglanz Waschtisch • Siphon inkl.

L		F1	F2	F3
60	MN4060CA			
70	MN4070CA			
80	MN4080CA			
90	MN4090CA			
105	MN4105CA			
120	MN4120CA			

### P 51,5

L		F1	F2	F3
60	MN4060CC			
70	MN4070CC			
80	MN4080CC			
90	MN4090CC			
105	MN4105CC			
120	MN4120CC			

### H 50

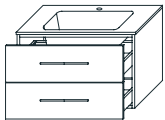

### P 46,5

Maniglia PONTE & chiusura ammortizzata • ceramica colore opaco lavabo centrale • 2 cassetti • sifone incl.  
 PONTE Handle & soft-closing • vanity unit 2 pull-out & ceramic color matt basin set • siphon incl.  
 Poignée PONTE & fermeture amortie • meuble avec plan-vasque en céramique colour mat • 2 tiroirs • siphon incl.  
 PONTE Griff • Waschtischunterschrank inkl. 2 Soft-Closing Schubladen & Keramik Matt Farbe Waschtisch • Siphon inkl.

L		F1	F2	F3
60	MN4060CB			
70	MN4070CB			
80	MN4080CB			
90	MN4090CB			
105	MN4105CB			

### P 51,5

L		F1	F2	F3
60	MN4060CD			
70	MN4070CD			
80	MN4080CD			
90	MN4090CD			
105	MN4105CD			
120	MN4120CD			

### H 50

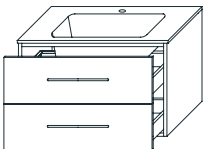

### P 46,5

Maniglia PONTE & chiusura ammortizzata • Castmarble bianco opaco/lucido lavabo centrale • 2 cassetti • sifone incl.  
 PONTE Handle & soft-closing • vanity unit 2 pull-out & Castmarble white matt/gloss basin set • siphon incl.  
 Poignée PONTE & fermeture amortie • meuble avec plan-vasque en Castmarble blanc mat/brillant • 2 tiroirs • siphon incl.  
 PONTE Griff • Waschtischunterschrank inkl. 2 Soft-Closing Schubladen & Castmarble weiß Matt/Hochglanz Waschtisch • Siphon inkl.

L		F1	F2	F3
60	MN4060CM			
70	MN4070CM			
80	MN4080CM			
90	MN4090CM			
105	MN4105CM			
120	MN4120CM			

### P 51,5

L		F1	F2	F3
60	MN4060CN			
70	MN4070CN			
80	MN4080CN			
90	MN4090CN			
105	MN4105CN			
120	MN4120CN			

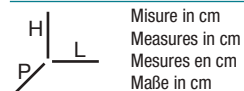

**F1** Laccato opaco  
Matt lacquered  
Laqué mat  
Matt lackiert

**F2** Laccato lucido  
Glossy lacquered  
Laqué brillant  
Hochglanz lackiert

**F3** Nobilitati  
Veneer wood  
Placage bois  
Beschichtetes Holz

**F4** Arock®  
Arock®  
Arock®  
Arock®

**F5** abitat / vogue  
abitat / vogue  
abitat / vogue  
abitat / vogue





ONESTO maniglia PONTE base L 90 P 46,5 Nobilitato legno & ceramica bianco opaco  
specchio illuminazione LED integrata Ø 90  
pensile a giorno L 45 H 50 P 18

## Basi con pianolavabo integrato Vanity units with basin

## Meubles avec plan-vasque Waschtischunterschranke

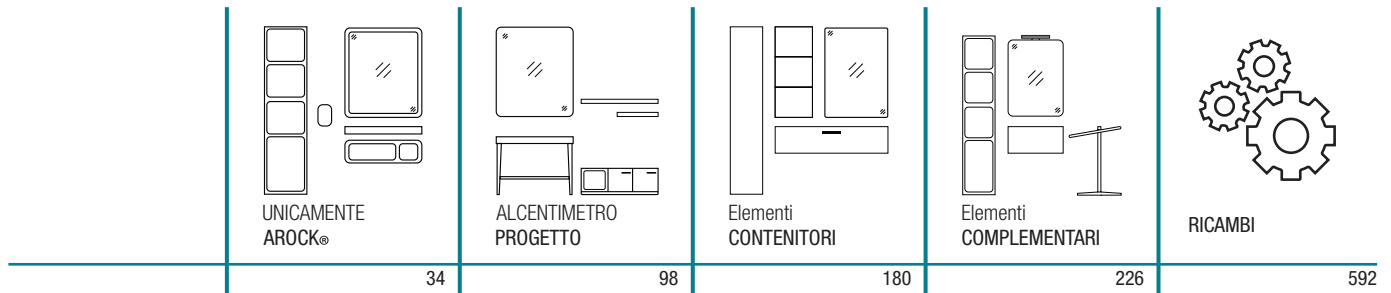

### H 50

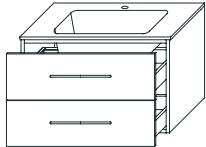

### P 46,5

Maniglia PONTE & chiusura ammortizzata • Castmarble Colori.02 lavabo centrale • 2 cassetti • sifone incl.  
 PONTE Handle & soft-closing • vanity unit 2 pull-out & Castmarble Colori.02 basin set • siphon incl.  
 Poignée PONTE & fermeture amortie • meuble avec plan-vasque en Castmarble Colori.02 • 2 tiroirs • siphon incl.  
 PONTE Griff • Waschtischunterschrank inkl. 2 Soft-Closing Schubladen & Castmarble Colori.02 Waschtisch • Siphon inkl.

L		F1	F2	F3
60	MN4060CP			
70	MN4070CP			
80	MN4080CP			
90	MN4090CP			
105	MN4105CP			
120	MN4120CP			

### P 51,5

L		F1	F2	F3
60	MN4060CR			
70	MN4070CR			
80	MN4080CR			
90	MN4090CR			
105	MN4105CR			
120	MN4120CR			

### H 50

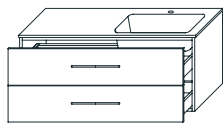

### P 51,5

Maniglia PONTE & chiusura ammortizzata • ceramica bianco lucido lavabo dx • 2 cassetti • sifone incl.  
 PONTE Handle & soft-closing • vanity unit 2 pull-out & ceramic white gloss basin set • siphon incl.  
 Poignée PONTE & fermeture amortie • meuble avec plan-vasque en céramique blanc brillant • 2 tiroirs • siphon incl.  
 PONTE Griff • Waschtischunterschrank inkl. 2 Soft-Closing Schubladen & Keramik weiß Hochglanz Waschtisch • Siphon inkl.

L		F1	F2	F3
105	MN4105DC			
120	MN4120DC			

### H 50

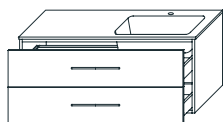

### P 51,5

Maniglia PONTE & chiusura ammortizzata • ceramica colore opaco lavabo dx • 2 cassetti • sifone incl.  
 PONTE Handle & soft-closing • vanity unit 2 pull-out & ceramic color matt basin set • siphon incl.  
 Poignée PONTE & fermeture amortie • meuble avec plan-vasque en céramique colour mat • 2 tiroirs • siphon incl.  
 PONTE Griff • Waschtischunterschrank inkl. 2 Soft-Closing Schubladen & Keramik Matt Farbe Waschtisch • Siphon inkl.

L		F1	F2	F3
105	MN4105DD			
120	MN4120DD			

H  
L  
P

Misure in cm  
Measures in cm  
Mesures en cm  
Maße in cm

**F1** Laccato opaco  
Matt lacquered  
Laqué mat  
Matt lackiert

**F2** Laccato lucido  
Glossy lacquered  
Laqué brillant  
Hochglanz lackiert

**F3** Nobilitati  
Veneer wood  
Placage bois  
Beschichtetes Holz

**F4** Arock®  
Arock®  
Arock®  
Arock®

**F5** abitat / vogue  
abitat / vogue  
abitat / vogue  
abitat / vogue



## Basi con pianolavabo integrato Vanity units with basin

## Meubles avec plan-vasque Waschtischunterschranke

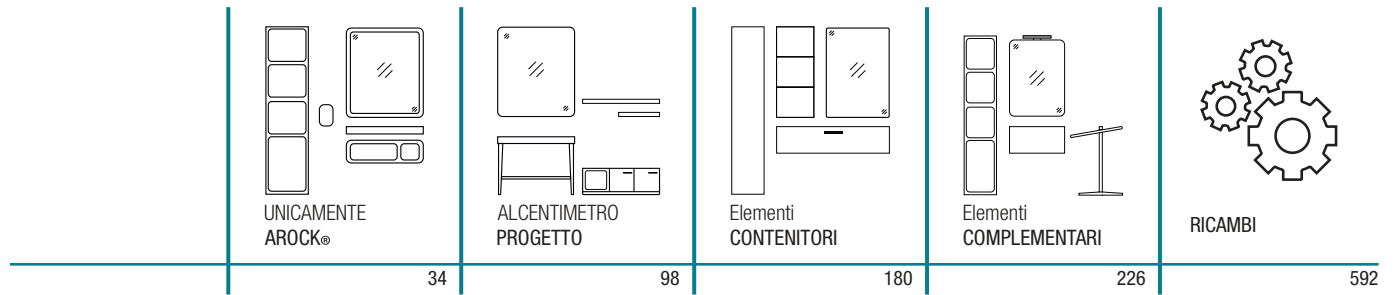

H 50

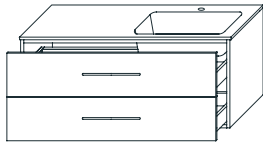

P 46,5

Maniglia PONTE & chiusura ammortizzata • Castmarble bianco opaco/lucido lavabo dx • 2 cassetti • sifone incl.  
 PONTE Handle & soft-closing • vanity unit 2 pull-out & Castmarble white matt/gloss basin set • siphon incl.  
 Poignée PONTE & fermeture amortie • meuble avec plan-vasque en Castmarble blanc mat/brillant • 2 tiroirs • siphon incl.  
 PONTE Griff • Waschtischunterschrank inkl. 2 Soft-Closing Schubladen & Castmarble weiß Matt/Hochglanz Waschtisch • Siphon inkl.

L		F1	F2	F3
105	MN4105DM			
120	MN4120DM			

P 51,5

L		F1	F2	F3
105	MN4105DN			
120	MN4120DN			

H 50

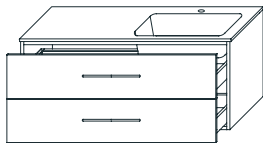

P 46,5

Maniglia PONTE & chiusura ammortizzata • Castmarble Colori.02 lavabo dx • 2 cassetti • sifone incl.  
 PONTE Handle & soft-closing • vanity unit 2 pull-out & Castmarble Colori.02 basin set • siphon incl.  
 Poignée PONTE & fermeture amortie • meuble avec plan-vasque en Castmarble Colori.02 • 2 tiroirs • siphon incl.  
 PONTE Griff • Waschtischunterschrank inkl. 2 Soft-Closing Schubladen & Castmarble Colori.02 Waschtisch • Siphon inkl.

L		F1	F2	F3
105	MN4105DP			
120	MN4120DP			

P 51,5

L		F1	F2	F3
105	MN4105DR			
120	MN4120DR			

H 50

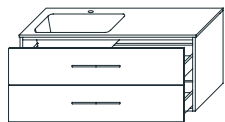

P 51,5

Maniglia PONTE & chiusura ammortizzata • ceramica bianco lucido lavabo sx • 2 cassetti • sifone incl.  
 PONTE Handle & soft-closing • vanity unit 2 pull-out & ceramic white gloss basin set • siphon incl.  
 Poignée PONTE & fermeture amortie • meuble avec plan-vasque en céramique blanc brillant • 2 tiroirs • siphon incl.  
 PONTE Griff • Waschtischunterschrank inkl. 2 Soft-Closing Schubladen & Keramik weiß Hochglanz Waschtisch • Siphon inkl.

L		F1	F2	F3
105	MN4105SC			
120	MN4120SC			

H  
L  
P

Misure in cm  
Measures in cm  
Mesures en cm  
Maße in cm

**F1** Laccato opaco  
Matt lacquered  
Laqué mat  
Matt lackiert

**F2** Laccato lucido  
Glossy lacquered  
Laqué brillant  
Hochglanz lackiert

**F3** Nobilitati  
Veneer wood  
Placage bois  
Beschichtetes Holz

**F4** Arock®  
Arock®  
Arock®  
Arock®



**F5** abitat / vogue  
abitat / vogue  
abitat / vogue  
abitat / vogue

## Basi con pianolavabo integrato

### Vanity units with basin

## Meubles avec plan-vasque

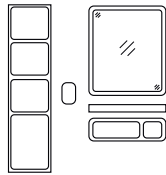
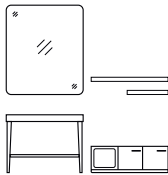
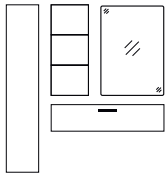
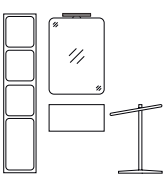
### Waschtischunterschranke

				
UNICAMENTE AROCK®	ALCENTIMETRO PROGETTO	Elementi CONTENTORI	Elementi COMPLEMENTARI	RICAMBI
34	98	180	226	592

#### H 50

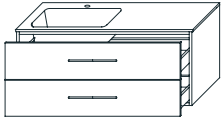

Maniglia PONTE & chiusura ammortizzata • ceramica colore opaco lavabo sx • 2 cassetti • sifone incl.  
 PONTE Handle & soft-closing • vanity unit 2 pull-out & ceramic color matt basin set • siphon incl.  
 Poignée PONTE & fermeture amortie • meuble avec plan-vasque en céramique colour mat • 2 tiroirs • siphon incl.  
 PONTE Griff • Waschtischunterschrank inkl. 2 Soft-Closing Schubladen & Keramik Matt Farbe Waschtisch • Siphon inkl.

#### P 51,5

L		F1	F2	F3
105	MN4105SD			
120	MN4120SD			

#### H 50

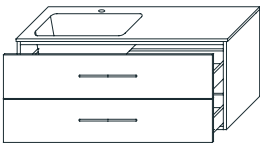

#### P 46,5

Maniglia PONTE & chiusura ammortizzata • Castmarble bianco opaco/lucido lavabo sx • 2 cassetti • sifone incl.  
 PONTE Handle & soft-closing • vanity unit 2 pull-out & Castmarble white matt/gloss basin set • siphon incl.  
 Poignée PONTE & fermeture amortie • meuble avec plan-vasque en Castmarble blanc mat/brillant • 2 tiroirs • siphon incl.  
 PONTE Griff • Waschtischunterschrank inkl. 2 Soft-Closing Schubladen & Castmarble weiß Matt/Hochglanz Waschtisch • Siphon inkl.

#### P 51,5

L		F1	F2	F3
105	MN4105SM			
120	MN4120SM			

L		F1	F2	F3
105	MN4105SN			
120	MN4120SN			

#### H 50

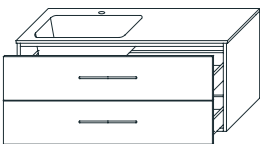

#### P 46,5

Maniglia PONTE & chiusura ammortizzata • Castmarble Colori.02 lavabo sx • 2 cassetti • sifone incl.  
 PONTE Handle & soft-closing • vanity unit 2 pull-out & Castmarble Colori.02 basin set • siphon incl.  
 Poignée PONTE & fermeture amortie • meuble avec plan-vasque en Castmarble Colori.02 • 2 tiroirs • siphon incl.  
 PONTE Griff • Waschtischunterschrank inkl. 2 Soft-Closing Schubladen & Castmarble Colori.02 Waschtisch • Siphon inkl.

#### P 51,5

L		F1	F2	F3
105	MN4105SP			
120	MN4120SP			

L		F1	F2	F3
105	MN4105SR			
120	MN4120SR			

H  
L  
P

Misure in cm  
Measures in cm  
Mesures en cm  
Maße in cm

**F1** Laccato opaco  
Matt lacquered  
Laqué mat  
Matt lackiert

**F2** Laccato lucido  
Glossy lacquered  
Laqué brillant  
Hochglanz lackiert

**F3** Nobilitati  
Veneer wood  
Placage bois  
Beschichtetes Holz

**F4** Arock®  
Arock®  
Arock®

**F5** abitat / vogue  
abitat / vogue  
abitat / vogue  
abitat / vogue

## Basi con pianolavabo integrato Vanity units with basin

## Meubles avec plan-vasque Waschtischunterschranke

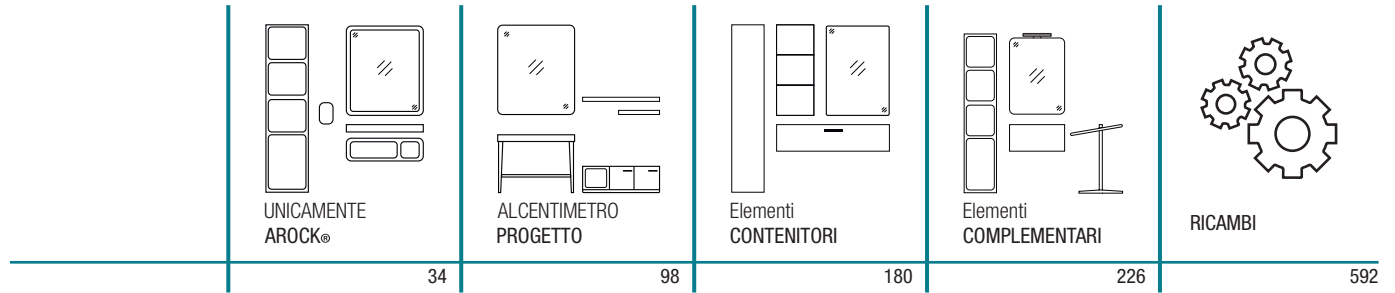

### H 50

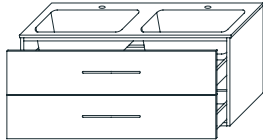

### P 46,5

Maniglia PONTE & chiusura ammortizzata • ceramica bianco lucido lavabo doppio • 2 cassettei • sifone incl.  
 PONTE Handle & soft-closing • vanity unit 2 pull-out & ceramic white gloss basin set • siphon incl.  
 Poignée PONTE & fermeture amortie • meuble avec plan-vasque en céramique blanc brillant • 2 tiroirs • siphon incl.  
 PONTE Griff • Waschtischunterschrank inkl. 2 Soft-Closing Schubladen & Keramik weiß Hochglanz Waschtisch • Siphon inkl.

L 120 MN4120TA

F1 F2 F3

### P 51,5

L 120 MN4120TC

F1 F2 F3

### H 50

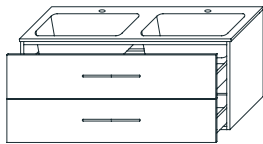

### P 51,5

Maniglia PONTE & chiusura ammortizzata • ceramica colore opaco lavabo doppio • 2 cassettei • sifone incl.  
 PONTE Handle & soft-closing • vanity unit 2 pull-out & ceramic color matt basin set • siphon incl.  
 Poignée PONTE & fermeture amortie • meuble avec plan-vasque en céramique colour mat • 2 tiroirs • siphon incl.  
 PONTE Griff • Waschtischunterschrank inkl. 2 Soft-Closing Schubladen & Keramik Matt Farbe Waschtisch • Siphon inkl.

L 120 MN4120TD

F1 F2 F3

### H 50

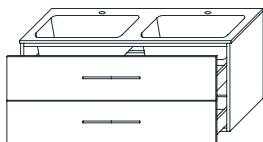

### P 46,5

Maniglia PONTE & chiusura ammortizzata • Castmarble bianco opaco/lucido lavabo doppio • 2 cassettei • sifone incl.  
 PONTE Handle & soft-closing • vanity unit 2 pull-out & Castmarble white matt/gloss basin set • siphon incl.  
 Poignée PONTE & fermeture amortie • meuble avec plan-vasque en Castmarble blanc mat/brillant • 2 tiroirs • siphon incl.  
 PONTE Griff • Waschtischunterschrank inkl. 2 Soft-Closing Schubladen & Castmarble weiß Matt/Hochglanz Waschtisch • Siphon inkl.

L 120 MN4120TM

F1 F2 F3

### P 51,5

L 120 MN4120TN

F1 F2 F3

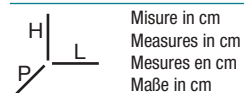

Misure in cm  
 Measures in cm  
 Mesures en cm  
 Maße in cm

**F1** Laccato opaco  
 Matt lacquered  
 Laqué mat  
 Matt lackiert

**F2** Laccato lucido  
 Glossy lacquered  
 Laqué brillant  
 Hochglanz lackiert



**F3** Nobilitati  
 Veneer wood  
 Placage bois  
 Beschichtetes Holz

**F4** Arock®  
 Arock®  
 Arock®  
 Arock®

**F5** abitat / vogue  
 abitat / vogue  
 abitat / vogue  
 abitat / vogue

## Basi con pianolavabo integrato Vanity units with basin

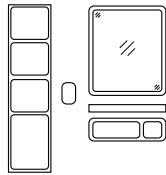
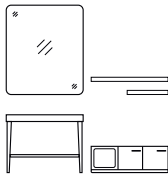
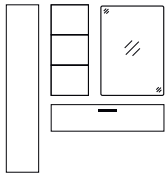
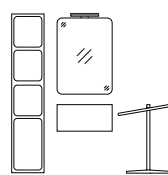
## Meubles avec plan-vasque Waschtischunterschranke

				
UNICAMENTE AROCK®	ALCENTIMETRO PROGETTO	Elementi CONTENTORI	Elementi COMPLEMENTARI	RICAMBI
34	98	180	226	592

### H 50

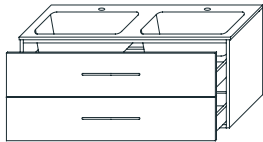

### P 46,5

Maniglia PONTE & chiusura ammortizzata • Castmarble Colori.02 lavabo doppio • 2 cassette • sifone incl.  
 PONTE Handle & soft-closing • vanity unit 2 pull-out & Castmarble Colori.02 basin set • siphon incl.  
 Poignée PONTE & fermeture amortie • meuble avec plan-vasque en Castmarble Colori.02 • 2 tiroirs • siphon incl.  
 PONTE Griff • Waschtischunterschrank inkl. 2 Soft-Closing Schubladen & Castmarble Colori.02 Waschtisch • Siphon inkl.

L	F1	F2	F3
120 MN4120TP			

### P 51,5

L	F1	F2	F3
120 MN4120TR			

### H 50

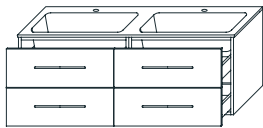

### P 51,5

Maniglia PONTE & chiusura ammortizzata • ceramica bianco lucido lavabo doppio • 4 cassette • sifone incl.  
 PONTE Handle & soft-closing • vanity unit 4 pull-out & ceramic white gloss basin set • siphon incl.  
 Poignée PONTE & fermeture amortie • meuble avec plan-vasque en céramique blanc brillant • 4 tiroirs • siphon incl.  
 PONTE Griff • Waschtischunterschrank inkl. 4 Soft-Closing Schubladen & Keramik weiß Hochglanz Waschtisch • Siphon inkl.

L	F1	F2	F3
140 MN4140TC			

### H 50

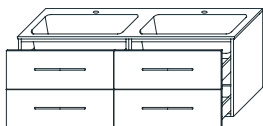

### P 51,5

Maniglia PONTE & chiusura ammortizzata • ceramica colore opaco lavabo doppio • 4 cassette • sifone incl.  
 PONTE Handle & soft-closing • vanity unit 4 pull-out & ceramic color matt basin set • siphon incl.  
 Poignée PONTE & fermeture amortie • meuble avec plan-vasque en céramique colour mat • 4 tiroirs • siphon incl.  
 PONTE Griff • Waschtischunterschrank inkl. 4 Soft-Closing Schubladen & Keramik Matt Farbe Waschtisch • Siphon inkl.

L	F1	F2	F3
140 MN4140TD			



Misure in cm  
 Measures in cm  
 Mesures en cm  
 Maße in cm

**F1** Laccato opaco  
 Matt lacquered  
 Laqué mat  
 Matt lackiert

**F2** Laccato lucido  
 Glossy lacquered  
 Laqué brillant  
 Hochglanz lackiert





**F3** Nobilitati  
 Veneer wood  
 Placage bois  
 Beschichtetes Holz

**F4** Arock®  
 Arock®  
 Arock®  
 Arock®

**F5** abitat / vogue  
 abitat / vogue  
 abitat / vogue  
 abitat / vogue

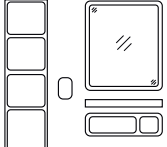
## Basi con pianolavabo integrato Vanity units with basin

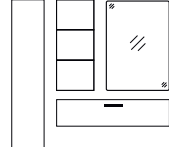
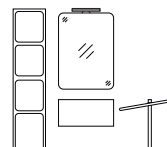
## Meubles avec plan-vasque Waschtischunterschranke

				
UNICAMENTE AROCK®	ALCENTIMETRO PROGETTO	Elementi CONTENITORI	Elementi COMPLEMENTARI	RICAMBI
34	98	180	226	592

### H 50

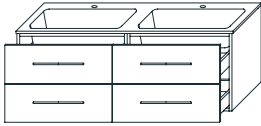

### P 46,5

Maniglia PONTE & chiusura ammortizzata • Castmarble bianco opaco/lucido lavabo doppio • 4 cassetti • sifone incl.  
 PONTE Handle & soft-closing • vanity unit 4 pull-out & Castmarble white matt/gloss basin set • siphon incl.  
 Poignée PONTE & fermeture amortie • meuble avec plan-vasque en Castmarble blanc mat/brillant • 4 tiroirs • siphon incl.  
 PONTE Griff • Waschtischunterschrank inkl. 4 Soft-Closing Schubladen & Castmarble weiß Matt/Hochglanz Waschtisch • Siphon inkl.

L 140 MN4140TM

F1 F2 F3

### P 51,5

L 140 MN4140TN

F1 F2 F3

### H 50

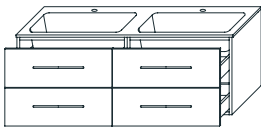

### P 46,5

Maniglia PONTE & chiusura ammortizzata • Castmarble Colori.02 lavabo doppio • 4 cassetti • sifone incl.  
 PONTE Handle & soft-closing • vanity unit 4 pull-out & Castmarble Colori.02 basin set • siphon incl.  
 Poignée PONTE & fermeture amortie • meuble avec plan-vasque en Castmarble Colori.02 • 4 tiroirs • siphon incl.  
 PONTE Griff • Waschtischunterschrank inkl. 4 Soft-Closing Schubladen & Castmarble Colori.02 Waschtisch • Siphon inkl.

L 140 MN4140TP

F1 F2 F3

### P 51,5

L 140 MN4140TR

F1 F2 F3

H  
L  
P

Misure in cm  
Measures in cm  
Mesures en cm  
Maße in cm

**F1** Laccato opaco  
Matt lacquered  
Laqué mat  
Matt lackiert

**F2** Laccato lucido  
Glossy lacquered  
Laqué brillant  
Hochglanz lackiert

**F3** Nobilitati  
Veneer wood  
Placage bois  
Beschichtetes Holz

**F4** Arock®  
Arock®  
Arock®  
Arock®

**F5** abitat / vogue  
abitat / vogue  
abitat / vogue  
abitat / vogue





ONESTO smusso 45° base L 140 P 51,5 Nobilitato legno & castmarble bianco lucido  
specchio illuminazione LED integrata Ø 60

## Basi con pianolavabo integrato Vanity units with basin

## Meubles avec plan-vasque Waschtischunterschranke

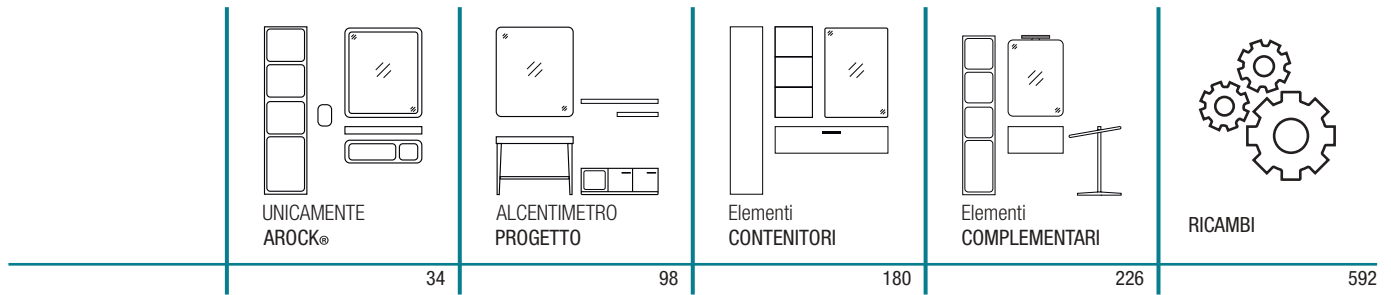

### H 50

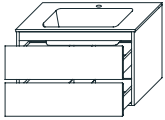

### P 46,5

Smusso 45° & chiusura ammortizzata • ceramica bianco lucido lavabo centrale • 2 cassetti • sifone incl.  
Smusso 45° & soft-closing • vanity unit 2 pull-out & ceramic white gloss basin set • siphon incl.  
Smusso 45° & fermetture amorte • meuble avec plan-vasque en céramique blanc brillant • 2 tiroirs • siphon incl.  
Smusso 45° • Waschtischunterschrank inkl. 2 Soft-Closing Schubladen & Keramik weiß Hochglanz Waschtisch • Siphon inkl.

L		F1	F2	F3
60	MN3060CA			
70	MN3070CA			
80	MN3080CA			
90	MN3090CA			
105	MN3105CA			
120	MN3120CA			

### P 51,5

L		F1	F2	F3
60	MN3060CC			
70	MN3070CC			
80	MN3080CC			
90	MN3090CC			
105	MN3105CC			
120	MN3120CC			

### H 50

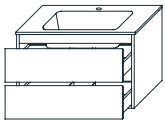

### P 46,5

Smusso 45° & chiusura ammortizzata • ceramica colore opaco lavabo centrale • 2 cassetti • sifone incl.  
Smusso 45° & soft-closing • vanity unit 2 pull-out & ceramic color matt basin set • siphon incl.  
Smusso 45° & fermetture amorte • meuble avec plan-vasque en céramique colour mat • 2 tiroirs • siphon incl.  
Smusso 45° • Waschtischunterschrank inkl. 2 Soft-Closing Schubladen & Keramik Matt Farbe Waschtisch • Siphon inkl.

L		F1	F2	F3
60	MN3060CB			
70	MN3070CB			
80	MN3080CB			
90	MN3090CB			
105	MN3105CB			

### P 51,5

L		F1	F2	F3
60	MN3060CD			
70	MN3070CD			
80	MN3080CD			
90	MN3090CD			
105	MN3105CD			
120	MN3120CD			

### H 50

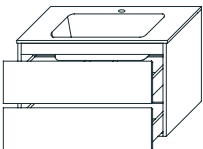

### P 46,5

Smusso 45° & chiusura ammortizzata • Castmarble bianco opaco/lucido lavabo centrale • 2 cassetti • sifone incl.  
Smusso 45° & soft-closing • vanity unit 2 pull-out & Castmarble white matt/gloss basin set • siphon incl.  
Smusso 45° & fermetture amorte • meuble avec plan-vasque en Castmarble blanc mat/brillant • 2 tiroirs • siphon incl.  
Smusso 45° • Waschtischunterschrank inkl. 2 Soft-Closing Schubladen & Castmarble weiß Matt/Hochglanz Waschtisch • Siphon inkl.

L		F1	F2	F3
60	MN3060CM			
70	MN3070CM			
80	MN3080CM			
90	MN3090CM			
105	MN3105CM			
120	MN3120CM			

### P 51,5

L		F1	F2	F3
60	MN3060CN			
70	MN3070CN			
80	MN3080CN			
90	MN3090CN			
105	MN3105CN			
120	MN3120CN			

H  
L  
P

Misure in cm  
Measures in cm  
Mesures en cm  
Maße in cm

**F1** Laccato opaco  
Matt lacquered  
Laqué mat  
Matt lackiert

**F2** Laccato lucido  
Glossy lacquered  
Laqué brillant  
Hochglanz lackiert

**F3** Nobilitati  
Veneer wood  
Placage bois  
Beschichtetes Holz

**F4** Arock®  
Arock®  
Arock®  
Arock®

**F5** abitat / vogue  
abitat / vogue  
abitat / vogue  
abitat / vogue



## Basi con pianolavabo integrato Vanity units with basin

## Meubles avec plan-vasque Waschtischunterschranke

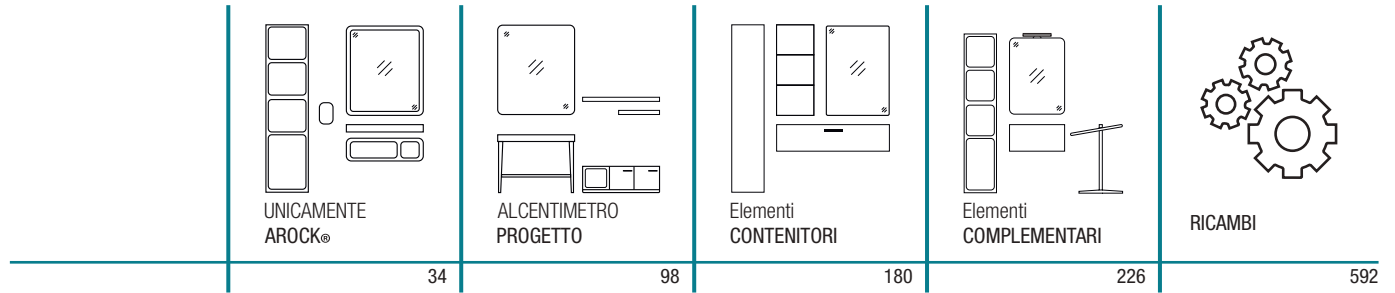

### H 50

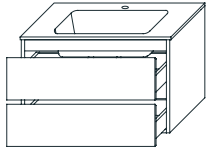

### P 46,5

Smusso 45° & chiusura ammortizzata • Castmarble Colori.02 lavabo centrale • 2 cassetti • sifone incl.  
Smusso 45° & soft-closing • vanity unit 2 pull-out & Castmarble Colori.02 basinset • siphon incl.  
Smusso 45° & fermeture amortie • meuble avec plan-vasque en Castmarble Colori.02 • 2 tiroirs • siphon incl.  
Smusso 45° • Waschtischunterschrank inkl. 2 Soft-Closing Schubladen & Castmarble Colori.02 Waschtisch • Siphon inkl.

L		F1	F2	F3
60	MN3060CP			
70	MN3070CP			
80	MN3080CP			
90	MN3090CP			
105	MN3105CP			
120	MN3120CP			

### P 51,5

L		F1	F2	F3
60	MN3060CR			
70	MN3070CR			
80	MN3080CR			
90	MN3090CR			
105	MN3105CR			
120	MN3120CR			

### H 50

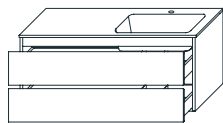

### P 51,5

Smusso 45° & chiusura ammortizzata • ceramica bianco lucido lavabo dx • 2 cassetti • sifone incl.  
Smusso 45° & soft-closing • vanity unit 2 pull-out & ceramic white gloss basin set • siphon incl.  
Smusso 45° & fermeture amortie • meuble avec plan-vasque en céramique blanc brillant • 2 tiroirs • siphon incl.  
Smusso 45° • Waschtischunterschrank inkl. 2 Soft-Closing Schubladen & Keramik weiß Hochglanz Waschtisch • Siphon inkl.

L		F1	F2	F3
105	MN3105DC			
120	MN3120DC			

### H 50

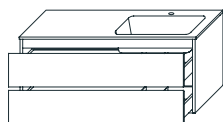

### P 51,5

Smusso 45° & chiusura ammortizzata • ceramica colore opaco lavabo dx • 2 cassetti • sifone incl.  
Smusso 45° & soft-closing • vanity unit 2 pull-out & ceramic color matt basin set • siphon incl.  
Smusso 45° & fermeture amortie • meuble avec plan-vasque en céramique colour mat • 2 tiroirs • siphon incl.  
Smusso 45° • Waschtischunterschrank inkl. 2 Soft-Closing Schubladen & Keramik Matt Farbe Waschtisch • Siphon inkl.

L		F1	F2	F3
105	MN3105DD			
120	MN3120DD			

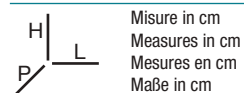

**F1** Laccato opaco  
Matt lacquered  
Laqué mat  
Matt lackiert

**F2** Laccato lucido  
Glossy lacquered  
Laqué brillant  
Hochglanz lackiert

**F3** Nobilitati  
Veneer wood  
Placage bois  
Beschichtetes Holz

**F4** Arock®  
Arock®  
Arock®  
Arock®

**F5** abitat / vogue  
abitat / vogue  
abitat / vogue  
abitat / vogue

# Basi con pianolavabo integrato Vanity units with basin

# Meubles avec plan-vasque Waschtischunterschranke

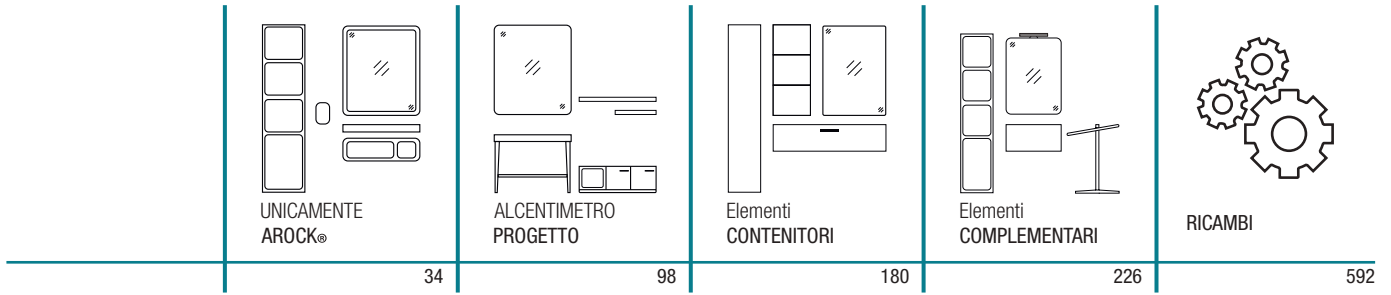

## H 50

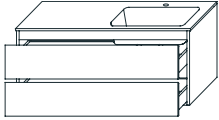

### P 46,5

Smusso 45° & chiusura ammortizzata • Castmarble bianco opaco/lucido lavabo dx • 2 cassetti • sifone incl.  
 Smusso 45° & soft-closing • vanity unit 2 pull-out & Castmarble white matt/gloss basin set • siphon incl.  
 Smusso 45° & fermeture amortie • meuble avec plan-vasque en Castmarble blanc mat/brillant • 2 tiroirs • siphon incl.  
 Smusso 45° • Waschtischunterschrank inkl. 2 Soft-Closing Schubladen & Castmarble weiß Matt/Hochglanz Waschtisch • Siphon inkl.

L		F1	F2	F3
105	MN3105DM			
120	MN3120DM			

### P 51,5

L		F1	F2	F3
105	MN3105DN			
120	MN3120DN			

## H 50

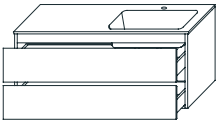

### P 46,5

Smusso 45° & chiusura ammortizzata • Castmarble Colori.02 lavabo dx • 2 cassetti • sifone incl.  
 Smusso 45° & soft-closing • vanity unit 2 pull-out & Castmarble Colori.02 basin set • siphon incl.  
 Smusso 45° & fermeture amortie • meuble avec plan-vasque en Castmarble Colori.02 • 2 tiroirs • siphon incl.  
 Smusso 45° • Waschtischunterschrank inkl. 2 Soft-Closing Schubladen & Castmarble Colori.02 Waschtisch • Siphon inkl.

L		F1	F2	F3
105	MN3105DP			
120	MN3120DP			

### P 51,5

L		F1	F2	F3
105	MN3105DR			
120	MN3120DR			

## H 50

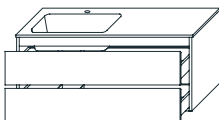

### P 51,5

Smusso 45° & chiusura ammortizzata • ceramica bianco lucido lavabo sx • 2 cassetti • sifone incl.  
 Smusso 45° & soft-closing • vanity unit 2 pull-out & ceramic white gloss basin set • siphon incl.  
 Smusso 45° & fermeture amortie • meuble avec plan-vasque en céramique blanc brillant • 2 tiroirs • siphon incl.  
 Smusso 45° • Waschtischunterschrank inkl. 2 Soft-Closing Schubladen & Keramik weiß Hochglanz Waschtisch • Siphon inkl.

L		F1	F2	F3
105	MN3105SC			
120	MN3120SC			

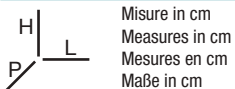

Misure in cm  
 Measures in cm  
 Mesures en cm  
 Maße in cm

**F1** Laccato opaco  
 Matt lacquered  
 Laqué mat  
 Matt lackiert

**F2** Laccato lucido  
 Glossy lacquered  
 Laqué brillant  
 Hochglanz lackiert





**F3** Nobilitati  
 Veneer wood  
 Placage bois  
 Beschichtetes Holz

**F4** Arock®  
 Arock®  
 Arock®  
 Arock®

**F5** abitat / vogue  
 abitat / vogue  
 abitat / vogue  
 abitat / vogue

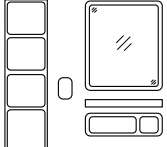
## Basi con pianolavabo integrato Vanity units with basin

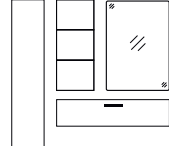
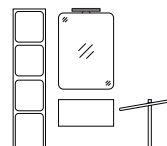
## Meubles avec plan-vasque Waschtischunterschranke

				
UNICAMENTE AROCK®	ALCENTIMETRO PROGETTO	Elementi CONTENITORI	Elementi COMPLEMENTARI	RICAMBI
34	98	180	226	592

### H 50

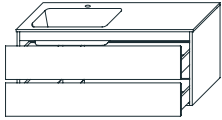

Smusso 45° & chiusura ammortizzata • ceramica colore opaco lavabo sx • 2 cassetti • sifone incl.  
Smusso 45° & soft-closing • vanity unit 2 pull-out & ceramic color matt basin set • siphon incl.  
Smusso 45° & fermetture amorte • meuble avec plan-vasque en céramique colour mat • 2 tiroirs • siphon incl.  
Smusso 45° • Waschtischunterschrank inkl. 2 Soft-Closing Schubladen & Keramik Matt Farbe Waschtisch • Siphon inkl.

### P 51,5

L	F1	F2	F3
105	MN3105SD		
120	MN3120SD		

### H 50

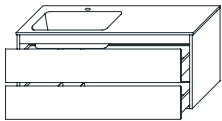

### P 46,5

Smusso 45° & chiusura ammortizzata • Castmarble bianco opaco/lucido lavabo sx • 2 cassetti • sifone incl.  
Smusso 45° & soft-closing • vanity unit 2 pull-out & Castmarble white matt/gloss basin set • siphon incl.  
Smusso 45° & fermetture amorte • meuble avec plan-vasque en Castmarble blanc mat/brillant • 2 tiroirs • siphon incl.  
Smusso 45° • Waschtischunterschrank inkl. 2 Soft-Closing Schubladen & Castmarble weiß Matt/Hochglanz Waschtisch • Siphon inkl.

### P 51,5

L	F1	F2	F3
105	MN3105SM		
120	MN3120SM		

L	F1	F2	F3
105	MN3105SN		
120	MN3120SN		

### H 50

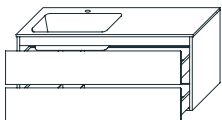

### P 46,5

Smusso 45° & chiusura ammortizzata • Castmarble Colori.02 lavabo sx • 2 cassetti • sifone incl.  
Smusso 45° & soft-closing • vanity unit 2 pull-out & Castmarble Colori.02 basin set • siphon incl.  
Smusso 45° & fermetture amorte • meuble avec plan-vasque en Castmarble Colori.02 • 2 tiroirs • siphon incl.  
Smusso 45° • Waschtischunterschrank inkl. 2 Soft-Closing Schubladen & Castmarble Colori.02 Waschtisch • Siphon inkl.

### P 51,5

L	F1	F2	F3
105	MN3105SP		
120	MN3120SP		

L	F1	F2	F3
105	MN3105SR		
120	MN3120SR		

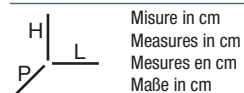

Misure in cm  
Measures in cm  
Mesures en cm  
Maße in cm

**F1** Laccato opaco  
Matt lacquered  
Laqué mat  
Matt lackiert

**F2** Laccato lucido  
Glossy lacquered  
Laqué brillant  
Hochglanz lackiert

**F3** Nobilitati  
Veneer wood  
Placage bois  
Beschichtetes Holz

**F4** Arock®  
Arock®  
Arock®  
Arock®

**F5** abitat / vogue  
abitat / vogue  
abitat / vogue  
abitat / vogue

# Basi con pianolavabo integrato Vanity units with basin

# Meubles avec plan-vasque Waschtischunterschranke

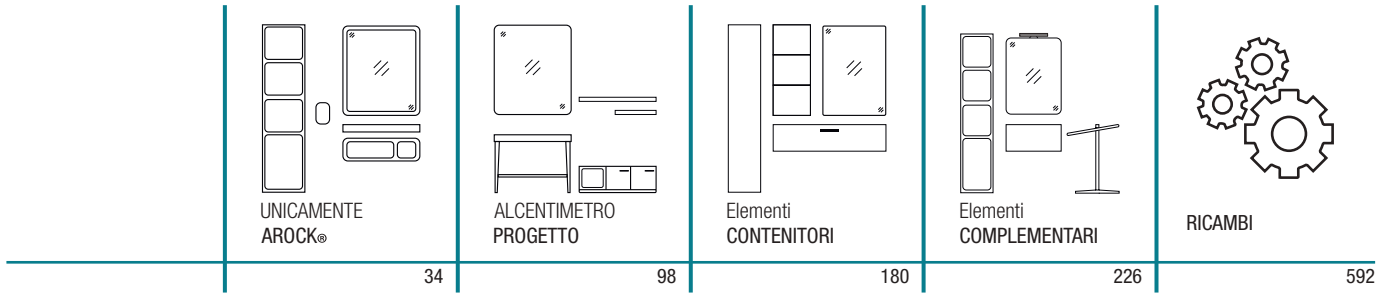

## H 50

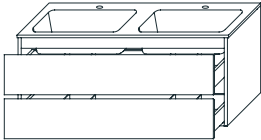

### P 46,5

Smusso 45° & chiusura ammortizzata • ceramica bianco lucido lavabo doppio • 2 cassetti • sifone incl.  
 Smusso 45° & soft-closing • vanity unit 2 pull-out & ceramic white gloss basin set • siphon incl.  
 Smusso 45° & fermeture amortie • meuble avec plan-vasque en céramique blanc brillant • 2 tiroirs • siphon incl.  
 Smusso 45° • Waschtischunterschrank inkl. 2 Soft-Closing Schubladen & Keramik weiß Hochglanz Waschtisch • Siphon inkl.

L	F1	F2	F3
120 MN3120TA			

### P 51,5

L	F1	F2	F3
120 MN3120TC			

## H 50

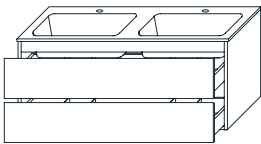

### P 51,5

Smusso 45° & chiusura ammortizzata • ceramica colore opaco lavabo doppio • 2 cassetti • sifone incl.  
 Smusso 45° & soft-closing • vanity unit 2 pull-out & ceramic color matt basin set • siphon incl.  
 Smusso 45° & fermeture amortie • meuble avec plan-vasque en céramique colour mat • 2 tiroirs • siphon incl.  
 Smusso 45° • Waschtischunterschrank inkl. 2 Soft-Closing Schubladen & Keramik Matt Farbe Waschtisch • Siphon inkl.

L	F1	F2	F3
120 MN3120TD			

## H 50

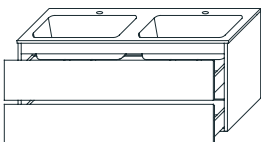

### P 46,5

Smusso 45° & chiusura ammortizzata • Castmarble bianco opaco/lucido lavabo doppio • 2 cassetti • sifone incl.  
 Smusso 45° & soft-closing • vanity unit 2 pull-out & Castmarble white matt/gloss basin set • siphon incl.  
 Smusso 45° & fermeture amortie • meuble avec plan-vasque en Castmarble blanc mat/brillant • 2 tiroirs • siphon incl.  
 Smusso 45° • Waschtischunterschrank inkl. 2 Soft-Closing Schubladen & Castmarble weiß Matt/Hochglanz Waschtisch • Siphon inkl.

L	F1	F2	F3
120 MN3120TM			

### P 51,5

L	F1	F2	F3
120 MN3120TN			



Misure in cm  
 Measures in cm  
 Mesures en cm  
 Maße in cm

**F1** Laccato opaco  
 Matt lacquered  
 Laqué mat  
 Matt lackiert

**F2** Laccato lucido  
 Glossy lacquered  
 Laqué brillant  
 Hochglanz lackiert

**F3** Nobilitati  
 Veneer wood  
 Placage bois  
 Beschichtetes Holz

**F4** Arock®  
 Arock®  
 Arock®  
 Arock®

**F5** abitat / vogue  
 abitat / vogue  
 abitat / vogue  
 abitat / vogue

## Basi con pianolavabo integrato Vanity units with basin

## Meubles avec plan-vasque Waschtischunterschranke

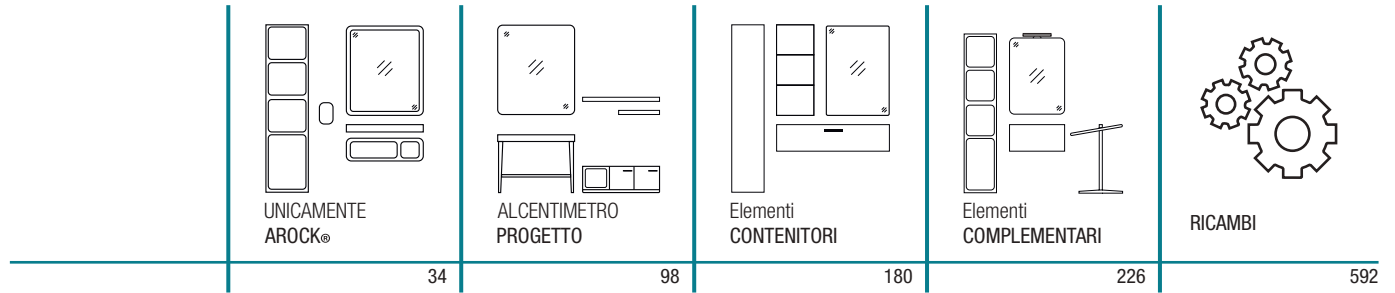
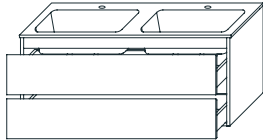
**H 50**

**P 46,5**

Smusso 45° & chiusura ammortizzata • Castmarble Colori.02 lavabo doppio • 2 cassetti • sifone incl.  
 Smusso 45° & soft-closing • vanity unit 2 pull-out & Castmarble Colori.02 basin set • siphon incl.  
 Smusso 45° & fermeture amortie • meuble avec plan-vasque en Castmarble Colori.02 • 2 tiroirs • siphon incl.  
 Smusso 45° • Waschtischunterschrank inkl. 2 Soft-Closing Schubladen & Castmarble Colori.02 Waschtisch • Siphon inkl.

L 120 MN3120TP

F1 F2 F3

**P 51,5**

L 120 MN3120TR

F1 F2 F3

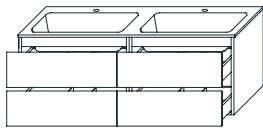
**H 50**

**P 51,5**

Smusso 45° & chiusura ammortizzata • ceramica bianco lucido lavabo doppio • 4 cassetti • sifone incl.  
 Smusso 45° & soft-closing • vanity unit 4 pull-out & ceramic white gloss basin set • siphon incl.  
 Smusso 45° & fermeture amortie • meuble avec plan-vasque en céramique blanc brillant • 4 tiroirs • siphon incl.  
 Smusso 45° • Waschtischunterschrank inkl. 4 Soft-Closing Schubladen & Keramik weiß Hochglanz Waschtisch • Siphon inkl.

L 140 MN3140TC

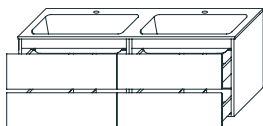
F1 F2 F3

**H 50**

**P 51,5**

Smusso 45° & chiusura ammortizzata • ceramica colore opaco lavabo doppio • 4 cassetti • sifone incl.  
 Smusso 45° & soft-closing • vanity unit 4 pull-out & ceramic color matt basin set • siphon incl.  
 Smusso 45° & fermeture amortie • meuble avec plan-vasque en céramique colour mat • 4 tiroirs • siphon incl.  
 Smusso 45° • Waschtischunterschrank inkl. 4 Soft-Closing Schubladen & Keramik Matt Farbe Waschtisch • Siphon inkl.

L 140 MN3140TD

F1 F2 F3

H  
L  
P

Misure in cm  
Measures in cm  
Mesures en cm  
Maße in cm

**F1** Laccato opaco  
Matt lacquered  
Laqué mat  
Matt lackiert

**F2** Laccato lucido  
Glossy lacquered  
Laqué brillant  
Hochglanz lackiert



**F3** Nobilitati  
Veneer wood  
Placage bois  
Beschichtetes Holz

**F4** Arock®  
Arock®  
Arock®  
Arock®

**F5** abitat / vogue  
abibat / vogue  
abibat / vogue  
abibat / vogue

## Basi con pianolavabo integrato Vanity units with basin

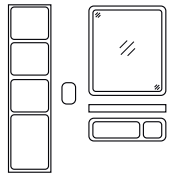
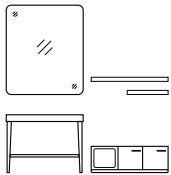
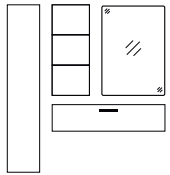
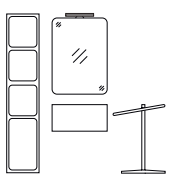
## Meubles avec plan-vasque Waschtischunterschranke

				
UNICAMENTE AROCK®	ALCENTIMETRO PROGETTO	Elementi CONTENTORI	Elementi COMPLEMENTARI	RICAMBI
34	98	180	226	592

### H 50

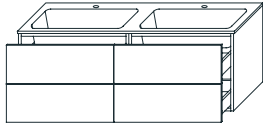

### P 46,5

Smusso 45° & chiusura ammortizzata • Castmarble bianco opaco/lucido lavabo doppio • 4 cassetti • sifone incl.  
Smusso 45° & soft-closing • vanity unit 4 pull-out & Castmarble white matt/gloss basin set • siphon incl.  
Smusso 45° & fermeture amortie • meuble avec plan-vasque en Castmarble blanc mat/brillant • 4 tiroirs • siphon incl.  
Smusso 45° • Waschtischunterschrank inkl. 4 Soft-Closing Schubladen & Castmarble weiß Matt/Hochglanz Waschtisch • Siphon inkl.

L 140 MN3140TM

F1

F2

F3

### P 51,5

Smusso 45° & chiusura ammortizzata • Castmarble bianco opaco/lucido lavabo doppio • 4 cassetti • sifone incl.  
Smusso 45° & soft-closing • vanity unit 4 pull-out & Castmarble white matt/gloss basin set • siphon incl.  
Smusso 45° & fermeture amortie • meuble avec plan-vasque en Castmarble blanc mat/brillant • 4 tiroirs • siphon incl.  
Smusso 45° • Waschtischunterschrank inkl. 4 Soft-Closing Schubladen & Castmarble weiß Matt/Hochglanz Waschtisch • Siphon inkl.

L 140 MN3140TN

F1

F2

F3

### H 50

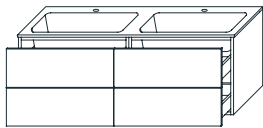

### P 46,5

Smusso 45° & chiusura ammortizzata • Castmarble Colori.02 lavabo doppio • 4 cassetti • sifone incl.  
Smusso 45° & soft-closing • vanity unit 4 pull-out & Castmarble Colori.02 basin set • siphon incl.  
Smusso 45° & fermeture amortie • meuble avec plan-vasque en Castmarble Colori.02 • 4 tiroirs • siphon incl.  
Smusso 45° • Waschtischunterschrank inkl. 4 Soft-Closing Schubladen & Castmarble Colori.02 Waschtisch • Siphon inkl.

L 140 MN3140TP

F1

F2

F3

### P 51,5

Smusso 45° & chiusura ammortizzata • Castmarble Colori.02 lavabo doppio • 4 cassetti • sifone incl.  
Smusso 45° & soft-closing • vanity unit 4 pull-out & Castmarble Colori.02 basin set • siphon incl.  
Smusso 45° & fermeture amortie • meuble avec plan-vasque en Castmarble Colori.02 • 4 tiroirs • siphon incl.  
Smusso 45° • Waschtischunterschrank inkl. 4 Soft-Closing Schubladen & Castmarble Colori.02 Waschtisch • Siphon inkl.

L 140 MN3140TR

F1

F2

F3



Misure in cm  
Measures in cm  
Mesures en cm  
Maße in cm

**F1** Laccato opaco  
Matt lacquered  
Laqué mat  
Matt lackiert

**F2** Laccato lucido  
Glossy lacquered  
Laqué brillant  
Hochglanz lackiert

**F3** Nobilitati  
Veneer wood  
Placage bois  
Beschichtetes Holz

**F4** Arock®  
Arock®  
Arock®  
Arock®

**F5** abitat / vogue  
abitat / vogue  
abitat / vogue  
abitat / vogue

## Basi con pianolavabo integrato Vanity units with basin

## Meubles avec plan-vasque Waschtischunterschranke

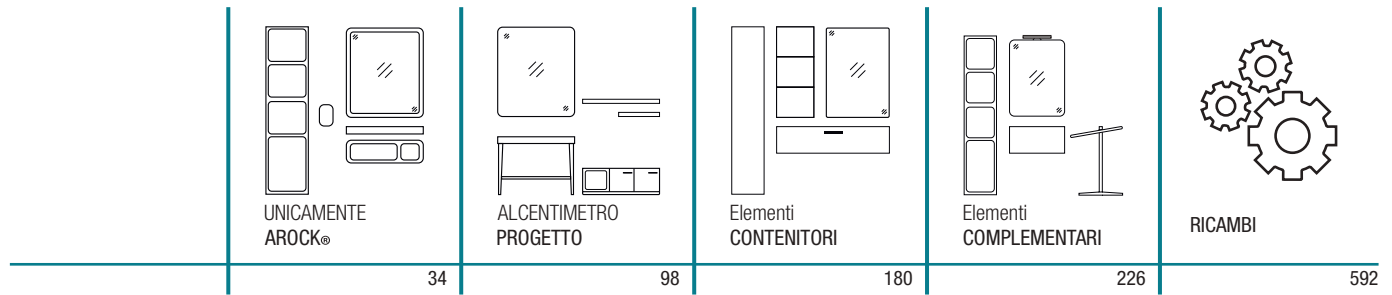

### H 50

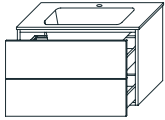

### P 46,5

Sistema Premi-Apri • ceramica bianco lucido lavabo centrale • 2 cassetti • sifone incl.  
Premi-Apri System • vanity unit 2 pull-out & ceramic white gloss basin set • siphon incl.  
Système Premi-Apri • meuble avec plan-vasque en céramique blanc brillant • 2 tiroirs • siphon incl.  
Premi-Apri System • Waschtischunterschrank inkl. 2 Schubladen & Keramik weiß Hochglanz Waschtisch • Siphon inkl.

L		F1	F2	F3
60	MN1060CA			
70	MN1070CA			
80	MN1080CA			
90	MN1090CA			
105	MN1105CA			
120	MN1120CA			

### P 51,5

L		F1	F2	F3
60	MN1060CC			
70	MN1070CC			
80	MN1080CC			
90	MN1090CC			
105	MN1105CC			
120	MN1120CC			

### H 50

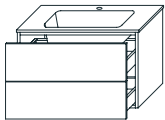

### P 46,5

Sistema Premi-Apri • ceramica colore opaco lavabo centrale • 2 cassetti • sifone incl.  
Premi-Apri System • vanity unit 2 pull-out & ceramic color matt basin set • siphon incl.  
Système Premi-Apri • meuble avec plan-vasque en céramique colour mat • 2 tiroirs • siphon incl.  
Premi-Apri System • Waschtischunterschrank inkl. 2 Schubladen & Keramik Matt Farbe Waschtisch • Siphon inkl.

L		F1	F2	F3
60	MN1060CB			
70	MN1070CB			
80	MN1080CB			
90	MN1090CB			
105	MN1105CB			

### P 51,5

L		F1	F2	F3
60	MN1060CD			
70	MN1070CD			
80	MN1080CD			
90	MN1090CD			
105	MN1105CD			
120	MN1120CD			

### H 50

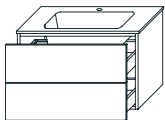

### P 46,5

Sistema Premi-Apri • Castmarble Colori.02 lavabo centrale • 2 cassetti • sifone incl.  
Premi-Apri System • vanity unit 2 pull-out & Castmarble Colori.02 basin set • siphon incl.  
Système Premi-Apri • meuble avec plan-vasque en Castmarble Colori.02 • 2 tiroirs • siphon incl.  
Premi-Apri System • Waschtischunterschrank inkl. 2 Schubladen & Castmarble Colori.02 Waschtisch • Siphon inkl.

L		F1	F2	F3
60	MN1060CM			
70	MN1070CM			
80	MN1080CM			
90	MN1090CM			
105	MN1105CM			
120	MN1120CM			

### P 51,5

L		F1	F2	F3
60	MN1060CN			
70	MN1070CN			
80	MN1080CN			
90	MN1090CN			
105	MN1105CN			
120	MN1120CN			

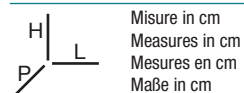

**F1** Laccato opaco  
Matt lacquered  
Laqué mat  
Matt lackiert

**F2** Laccato lucido  
Glossy lacquered  
Laqué brillant  
Hochglanz lackiert

**F3** Nobilitati  
Veneer wood  
Placage bois  
Beschichtetes Holz

**F4** Arock®  
Arock®  
Arock®  
Arock®

**F5** abitat / vogue  
abitat / vogue  
abitat / vogue  
abitat / vogue







ONESTO Premi-Aprì base L 120 P 51,5 laccato opaco & ceramica colore opaco  
specchio AERO illuminazione LED frontale integrata L 70 H 75  
vano a giorno orizzontale L 70 H 25 P 18  
mensola laccato opaco L 90 P 18

## Basi con pianolavabo integrato Vanity units with basin

## Meubles avec plan-vasque Waschtischunterschranke

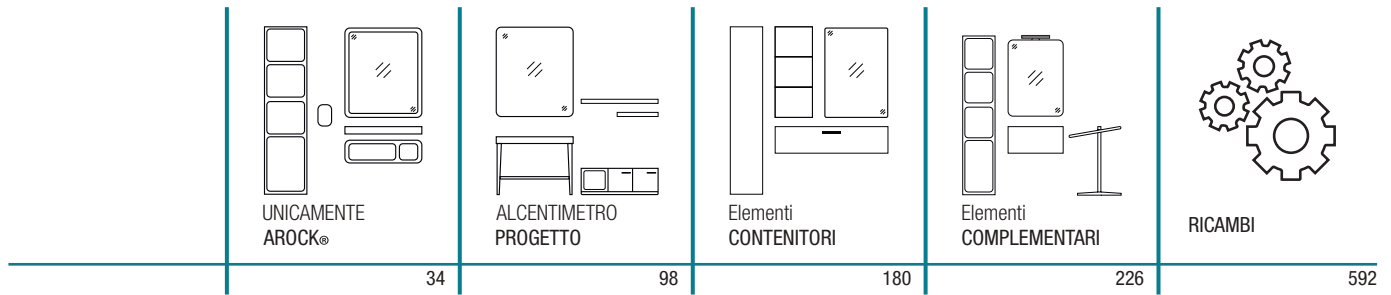

### H 50

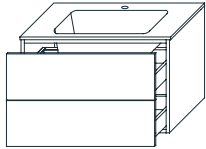

### P 46,5

Sistema Premi-Apri • ceramica bianco lucido lavabo centrale • 2 cassetti • sifone incl.  
 Premi-Apri System • vanity unit 2 pull-out & ceramic white gloss basin set • siphon incl.  
 Système Premi-Apri • meuble avec plan-vasque en céramique blanc brillant • 2 tiroirs • siphon incl.  
 Premi-Apri System • Waschtischunterschrank inkl. 2 Schubladen & Keramik weiß Hochglanz Waschtisch • Siphon inkl.

L		F1	F2	F3
60	MN1060CP			
70	MN1070CP			
80	MN1080CP			
90	MN1090CP			
105	MN1105CP			
120	MN1120CP			

### P 51,5

L		F1	F2	F3
60	MN1060CR			
70	MN1070CR			
80	MN1080CR			
90	MN1090CR			
105	MN1105CR			
120	MN1120CR			

### H 50

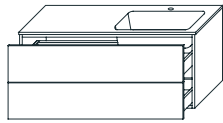

### P 51,5

Sistema Premi-Apri • ceramica bianco lucido lavabo dx • 2 cassetti • sifone incl.  
 Premi-Apri System • vanity unit 2 pull-out & ceramic white gloss basin set • siphon incl.  
 Système Premi-Apri • meuble avec plan-vasque en céramique blanc brillant • 2 tiroirs • siphon incl.  
 Premi-Apri System • Waschtischunterschrank inkl. 2 Schubladen & Keramik weiß Hochglanz Waschtisch • Siphon inkl.

L		F1	F2	F3
105	MN1105DC			
120	MN1120DC			

### H 50

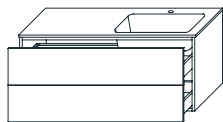

### P 51,5

Sistema Premi-Apri • Castmarble bianco opaco/lucido lavabo dx • 2 cassetti • sifone incl.  
 Premi-Apri System • vanity unit 2 pull-out & Castmarble white matt/gloss basin set • siphon incl.  
 Système Premi-Apri • meuble avec plan-vasque en céramique colour mat/brillant • 2 tiroirs • siphon incl.  
 Premi-Apri System • Waschtischunterschrank inkl. 2 Schubladen & Castmarble weiß Matt/Hochglanz Waschtisch • Siphon inkl.

L		F1	F2	F3
105	MN1105DD			
120	MN1120DD			

H  
L  
P

Misure in cm  
 Measures in cm  
 Mesures en cm  
 Maße in cm

**F1** Laccato opaco  
 Matt lacquered  
 Laqué mat  
 Matt lackiert

**F2** Laccato lucido  
 Glossy lacquered  
 Laqué brillant  
 Hochglanz lackiert

**F3** Nobilitati  
 Veneer wood  
 Placage bois  
 Beschichtetes Holz

**F4** Arock®  
 Arock®  
 Arock®  
 Arock®

**F5** abitat / vogue  
 abitat / vogue  
 abitat / vogue  
 abitat / vogue

## Basi con pianolavabo integrato Vanity units with basin

## Meubles avec plan-vasque Waschtischunterschänke

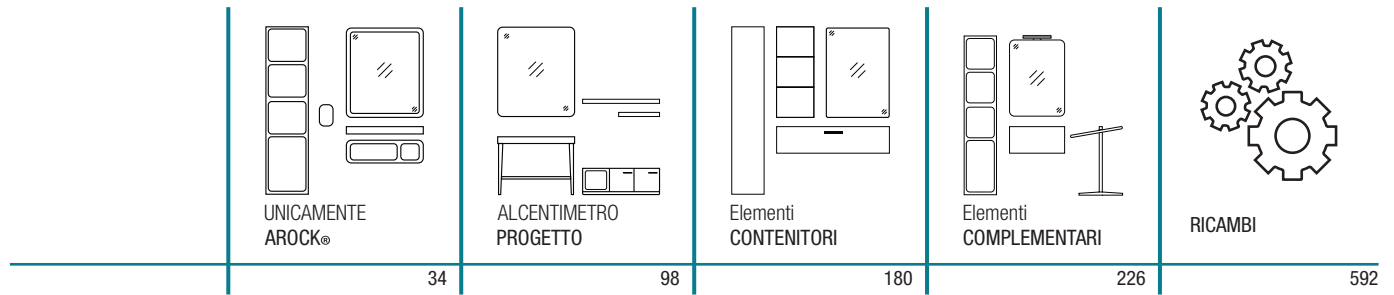
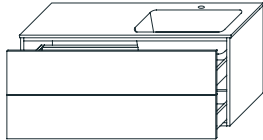

**H 50**

**P 46,5**

Sistema Premi-Apri • Castmarble bianco opaco/lucido lavabo dx • 2 cassetti • sifone incl.  
 Premi-Apri System • vanity unit 2 pull-out & Castmarble white matt/gloss basin set • siphon incl.  
 Système Premi-Apri • meuble avec plan-vasque en Castmarble blanc mat/brillant • 2 tiroirs • siphon incl.  
 Premi-Apri System • Waschtischunterschrank inkl. 2 Schubladen & Castmarble weiß Matt/Hochglanz Waschtisch • Siphon inkl.

L		F1	F2	F3
105	MN1105DM			
120	MN1120DM			

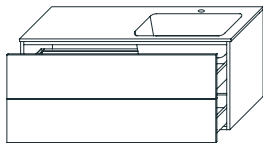
**P 51,5**

L		F1	F2	F3
105	MN1105DN			
120	MN1120DN			

**H 50**

**P 46,5**

Sistema Premi-Apri • Castmarble Colori.02 lavabo dx • 2 cassetti • sifone incl.  
 Premi-Apri System • vanity unit 2 pull-out & Castmarble Colori.02 basin set • siphon incl.  
 Système Premi-Apri • meuble avec plan-vasque en Castmarble Colori.02 • 2 tiroirs • siphon incl.  
 Premi-Apri System • Waschtischunterschrank inkl. 2 Schubladen & Castmarble Colori.02 Waschtisch • Siphon inkl.

L		F1	F2	F3
105	MN1105DP			
120	MN1120DP			

**P 51,5**

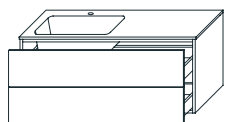
L		F1	F2	F3
105	MN1105DR			
120	MN1120DR			

**H 50**

**P 51,5**

Sistema Premi-Apri • ceramica bianco lucido lavabo sx • 2 cassetti • sifone incl.  
 Premi-Apri System • vanity unit 2 pull-out & ceramic white gloss basin set • siphon incl.  
 Système Premi-Apri • meuble avec plan-vasque en céramique blanc brillant • 2 tiroirs • siphon incl.  
 Premi-Apri System • Waschtischunterschrank inkl. 2 Schubladen & Keramik weiß Hochglanz Waschtisch • Siphon inkl.

L		F1	F2	F3
105	MN1105SC			
120	MN1120SC			

H  
L  
P

Misure in cm  
 Measures in cm  
 Mesures en cm  
 Maße in cm

**F1** Laccato opaco  
 Matt lacquered  
 Laqué mat  
 Matt lackiert

**F2** Laccato lucido  
 Glossy lacquered  
 Laqué brillant  
 Hochglanz lackiert

**F3** Nobilitati  
 Veneer wood  
 Placage bois  
 Beschichtetes Holz

**F4** Arock®  
 Arock®  
 Arock®  
 Arock®

**F5** abitat / vogue  
 abitat / vogue  
 abitat / vogue  
 abitat / vogue

## Basi con pianolavabo integrato

### Vanity units with basin

## Meubles avec plan-vasque

### Waschtischunterschranke

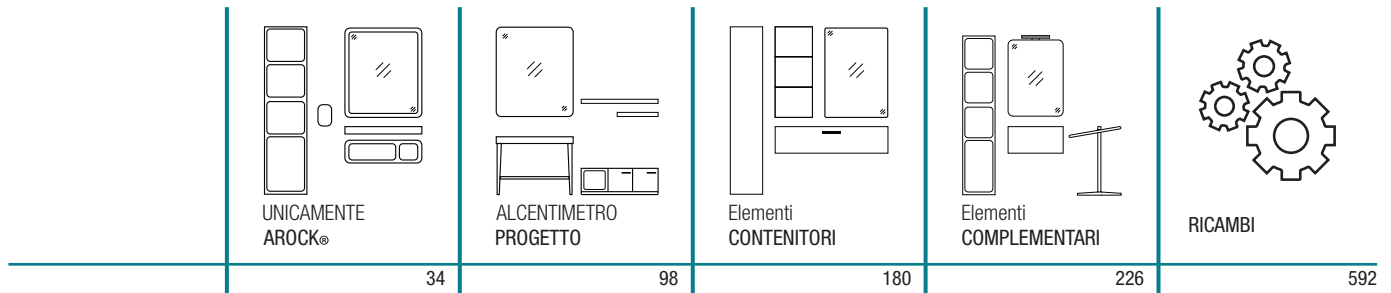

#### H 50

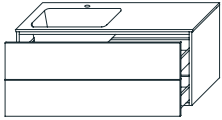

Sistema Premi-Apri • ceramica colore opaco lavabo sx • 2 cassetti • sifone incl.  
 Premi-Apri System • vanity unit 2 pull-out & ceramic color matt basin set • siphon incl.  
 Système Premi-Apri • meuble avec plan-vasque en céramique colour mat • 2 tiroirs • siphon incl.  
 Premi-Apri System • Waschtischunterschrank inkl. 2 Schubladen & Keramik Matt Farbe Waschtisch • Siphon inkl.

#### P 51,5

L		F1	F2	F3
105	MN1105SD			
120	MN1120SD			

#### H 50

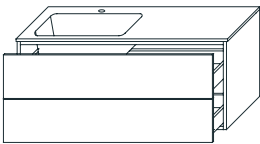

#### P 46,5

Sistema Premi-Apri • Castmarble bianco opaco/lucido lavabo sx • 2 cassetti • sifone incl.  
 Premi-Apri System • vanity unit 2 pull-out & Castmarble white matt/gloss basin set • siphon incl.  
 Système Premi-Apri • meuble avec plan-vasque en Castmarble blanc mat/brillant • 2 tiroirs • siphon incl.  
 Premi-Apri System • Waschtischunterschrank inkl. 2 Schubladen & Castmarble weiß Matt/Hochglanz Waschtisch • Siphon inkl.

#### P 51,5

L		F1	F2	F3
105	MN1105SM			
120	MN1120SM			

L		F1	F2	F3
105	MN1105SN			
120	MN1120SN			

#### H 50

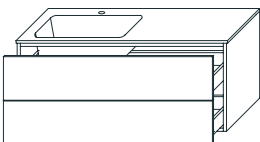

#### P 46,5

Sistema Premi-Apri • Castmarble Colori.02 lavabo sx • 2 cassetti • sifone incl.  
 Premi-Apri System • vanity unit 2 pull-out & Castmarble Colori.02 basin set • siphon incl.  
 Système Premi-Apri • meuble avec plan-vasque en Castmarble Colori.02 • 2 tiroirs • siphon incl.  
 Premi-Apri System • Waschtischunterschrank inkl. 2 Schubladen & Castmarble Colori.02 Waschtisch • Siphon inkl.

#### P 51,5

L		F1	F2	F3
105	MN1105SP			
120	MN1120SP			

L		F1	F2	F3
105	MN1105SR			
120	MN1120SR			

H  
L  
P

Misure in cm  
 Measures in cm  
 Mesures en cm  
 Maße in cm

**F1** Laccato opaco  
 Matt lacquered  
 Laqué mat  
 Matt lackiert

**F2** Laccato lucido  
 Glossy lacquered  
 Laqué brillant  
 Hochglanz lackiert

**F3** Nobilitati  
 Veneer wood  
 Placage bois  
 Beschichtetes Holz

**F4** Arock®  
 Arock®  
 Arock®  
 Arock®

**F5** abitat / vogue  
 abitat / vogue  
 abitat / vogue  
 abitat / vogue

# Basi con pianolavabo integrato Vanity units with basin

# Meubles avec plan-vasque Waschtischunterschranke

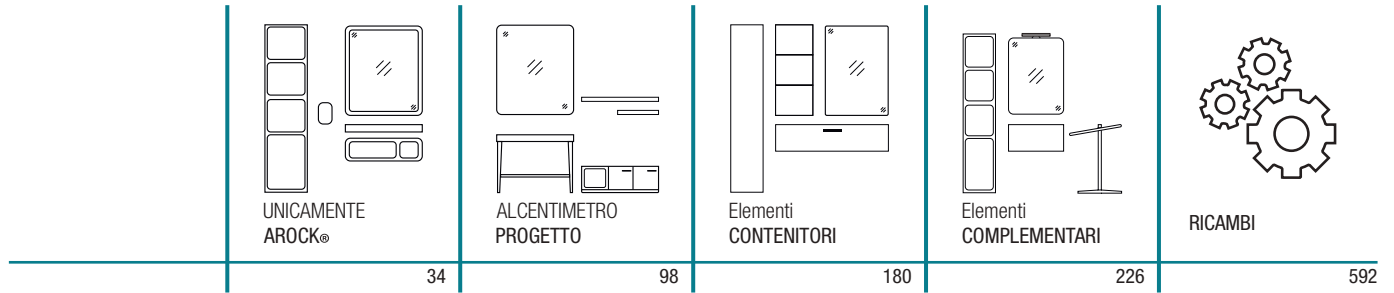

**H 50**

**P 46,5**

Sistema Premi-Aprì • ceramica bianco lucido lavabo doppio • 2 cassetti • sifone incl.  
 Premi-Aprì System • vanity unit 2 pull-out & ceramic white gloss basin set • siphon incl.  
 Système Premi-Aprì • meuble avec plan-vasque en céramique blanc brillant • 2 tiroirs • siphon incl.  
 Premi-Aprì System • Waschtischunterschrank inkl. 2 Schubladen & Keramik weiß Hochglanz Waschtisch • Siphon inkl.

<b>L</b>	<b>F1</b>	<b>F2</b>	<b>F3</b>
120	MN1120TA		

**H 50**

**P 51,5**

Sistema Premi-Aprì • ceramica colore opaco lavabo doppio • 2 cassetti • sifone incl.  
 Premi-Aprì System • vanity unit 2 pull-out & ceramic color matt basin set • siphon incl.  
 Système Premi-Aprì • meuble avec plan-vasque en céramique colour mat • 2 tiroirs • siphon incl.  
 Premi-Aprì System • Waschtischunterschrank inkl. 2 Schubladen & Keramik Matt Farbe Waschtisch • Siphon inkl.

<b>L</b>	<b>F1</b>	<b>F2</b>	<b>F3</b>
120	MN1120TD		

**H 50**

**P 46,5**





Sistema Premi-Aprì • Castmarble Colori.02 lavabo doppio • 2 cassetti • sifone incl.  
 Premi-Aprì System • vanity unit 2 pull-out & Castmarble Colori.02 basin set • siphon incl.  
 Système Premi-Aprì • meuble avec plan-vasque en Castmarble Colori.02 • 2 tiroirs • siphon incl.  
 Premi-Aprì System • Waschtischunterschrank inkl. 2 Schubladen & Castmarble Colori.02 Waschtisch • Siphon inkl.

<b>L</b>	<b>F1</b>	<b>F2</b>	<b>F3</b>
120	MN1120TM		

	Misure in cm Measures in cm Mesures en cm Maße in cm	<b>F1</b> Laccato opaco Matt lacquered Laqué mat Matt lackiert	<b>F2</b> Laccato lucido Glossy lacquered Laqué brillant Hochglanz lackiert	<b>F3</b> Nobilitati Veneer wood Placage bois Beschichtetes Holz	<b>F4</b> Arock® Arock® Arock® Arock®	<b>F5</b> abitat / vogue abitat / vogue abitat / vogue abitat / vogue

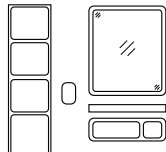
## Basi con pianolavabo integrato Vanity units with basin

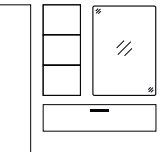
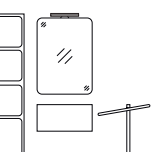
## Meubles avec plan-vasque Waschtischunterschranke

				
UNICAMENTE AROCK®	ALCENTIMETRO PROGETTO	Elementi CONTENTORI	Elementi COMPLEMENTARI	RICAMBI
34	98	180	226	592

### H 50

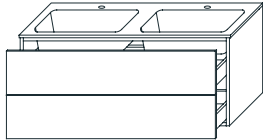

### P 46,5

Sistema Premi-Apri • Castmarble bianco opaco/lucido lavabo centrale • 2 cassettei • sifone incl.  
 Premi-Apri System • vanity unit 2 pull-out & Castmarble white matt/gloss basin set • siphon incl.  
 Système Premi-Apri • meuble avec plan-vasque en Castmarble blanc mat/brillant • 2 tiroirs • siphon incl.  
 Premi-Apri System • Waschtischunterschrank inkl. 2 Schubladen & Castmarble weiß Matt/Hochglanz Waschtisch • Siphon inkl.

L 120 MN1120TP

F1

F2

F3

### P 51,5

L 120 MN1120TR

F1

F2

F3

### H 50

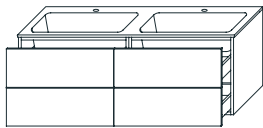

### P 51,5

Sistema Premi-Apri • ceramica bianco lucido lavabo doppio • 4 cassettei • sifone incl.  
 Premi-Apri System • vanity unit 4 pull-out & ceramic white gloss basin set • siphon incl.  
 Système Premi-Apri • meuble avec plan-vasque en céramique blanc brillant • 4 tiroirs • siphon incl.  
 Premi-Apri System • Waschtischunterschrank inkl. 4 Schubladen & Keramik weiß Hochglanz Waschtisch • Siphon inkl.

L 140 MN1140TC

F1

F2

F3

### H 50

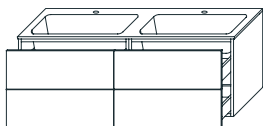

### P 51,5

Sistema Premi-Apri • ceramica colore opaco lavabo doppio • 4 cassettei • sifone incl.  
 Premi-Apri System • vanity unit 4 pull-out & ceramic color matt basin set • siphon incl.  
 Système Premi-Apri • meuble avec plan-vasque en céramique colour mat • 4 tiroirs • siphon incl.  
 Premi-Apri System • Waschtischunterschrank inkl. 4 Schubladen & Keramik Matt Farbe Waschtisch • Siphon inkl.

L 140 MN1140TD

F1

F2

F3

H  
L  
P

Misure in cm  
Measures in cm  
Mesures en cm  
Maße in cm

**F1** Laccato opaco  
Matt lacquered  
Laqué mat  
Matt lackiert

**F2** Laccato lucido  
Glossy lacquered  
Laqué brillant  
Hochglanz lackiert





**F3** Nobilitati  
Veneer wood  
Placage bois  
Beschichtetes Holz

**F4** Arock®  
Arock®  
Arock®

**F5** abitat / vogue  
abitat / vogue  
abitat / vogue  
abitat / vogue

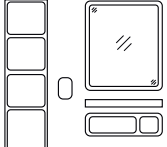
## Basi con pianolavabo integrato Vanity units with basin

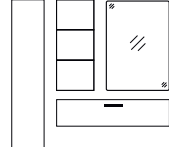
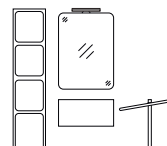
## Meubles avec plan-vasque Waschtischunterschänke

				
UNICAMENTE AROCK®	ALCENTIMETRO PROGETTO	Elementi CONTENITORI	Elementi COMPLEMENTARI	RICAMBI
34	98	180	226	592

### H 50

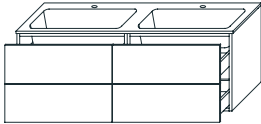

### P 46,5

Sistema Premi-Apri • Castmarble Colori.02 lavabo doppio • 4 cassetti • sifone incl.  
 Premi-Apri System • vanity unit 4 pull-out & Castmarble Colori.02 basin set • siphon incl.  
 Système Premi-Apri • meuble avec plan-vasque en Castmarble Colori.02 • 4 tiroirs • siphon incl.  
 Premi-Apri System • Waschtischunterschrank inkl. 4 Schubladen & Castmarble Colori.02 Waschtisch • Siphon inkl.

L 140 MN1140TM

F1 F2 F3

### P 51,5

L 140 MN1140TN

F1 F2 F3

### H 50

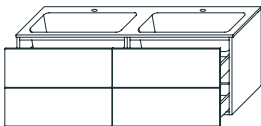

### P 46,5

Sistema Premi-Apri • Castmarble bianco opaco/lucido lavabo centrale • 4 cassetti • sifone incl.  
 Premi-Apri System • vanity unit 4 pull-out & Castmarble white matt/gloss basin set • siphon incl.  
 Système Premi-Apri • meuble avec plan-vasque en Castmarble blanc mat/brillant • 4 tiroirs • siphon incl.  
 Premi-Apri System • Waschtischunterschrank inkl. 4 Schubladen & Castmarble weiß Matt/Hochglanz Waschtisch • Siphon inkl.

L 140 MN1140TP

F1 F2 F3

### P 51,5

L 140 MN1140TR

F1 F2 F3

H  
L  
P

Misure in cm  
Measures in cm  
Mesures en cm  
Maße in cm

**F1** Laccato opaco  
Matt lacquered  
Laqué mat  
Matt lackiert

**F2** Laccato lucido  
Glossy lacquered  
Laqué brillant  
Hochglanz lackiert

**F3** Nobilitati  
Veneer wood  
Placage bois  
Beschichtetes Holz

**F4** Arock®  
Arock®  
Arock®  
Arock®

**F5** abitat / vogue  
abitat / vogue  
abitat / vogue  
abitat / vogue





MOBILI COMPATTI

**LIBERO**



# L I B E R O

mobile compatto progettato per consentire una immediata comprensione, una notevole facilità di vendita e un'adeguata convenienza

il gusto incontra la personalizzazione nelle finiture, nelle colorazioni e nella posizione della fascia maniglia superiore o centrale, realizzata in quarantotto colori in un unico pezzo



meubles de bain compacts étudiés pour permettre une compréhension immédiate, une commodité adéquate et des ventes remarquables

le goût rencontre la personnalisation dans les finitions, les couleurs et dans la position du profil poignée en une seule pièce

compact bath furniture designed to enable immediate understanding, adequate suitability, and remarkable sales

taste meets the personalization of finishes, colors, and handle profile's position. The latter is made of a single piece and can be finalized with TDA's forty-eight colors



kompakte Badmöbel für sofortiges Verständnis, Comfort und bemerkenswerte Verkaufszahlen

geschmack trifft personalisierung in Oberflächen, Farben und in der Position des Griffprofils aus einem Stück

**A filopiano lavabo integrato / integrated plan washbasin / vasque en plan intégrée / integrierte Waschtischplatte**

<b>FINITURE:</b> CASTMARBLE 1,2 cm bianco opaco/ lucido & 48 colori.02 <b>PROFONDITÀ:</b> 46-51,5 cm	<b>FINISHES:</b> CASTMARBLE 1,2 cm matt and glossy white & 48 colori.02 <b>DEPTH:</b> 46-51,5 cm	<b>FINITIONS:</b> CASTMARBLE 1,2 cm blanc mat et brillant & 48 colori.02 <b>PROFONDEUR:</b> 46-51,5 cm	<b>OBERFLÄCHEN:</b> CASTMARBLE weiß matt und glänz- end & 48 colori.02 <b>TIEFE:</b> 46-51,5 cm
--	--	--	---

**B contenitore / interior configuration / configuration intérieure / Innenausstattung**

realizzato in pannelli di particelle di legno di spessore 16 mm, idrofughi, nobilitato con carta melaminica colore URBAN. Bordi in ABS in tinta. Cassetto montato su guide GRASS® ad estrazione totale con sponde laterali in metallo verniciato colore URBAN. Fondo e schienale nobilitati finitura contenitore <b>ALTEZZA:</b> 55,5 cm <b>PROFONDITÀ:</b> 46-51,5 cm <b>LARGHEZZA:</b> 60-70-80-90-105-120-140 cm	made of water repellent panels of 16 mm thick wood particles, covered with Nobilitato URBAN color. Matching ABS edges Drawer mounted on full extension GRASS® runners with URBAN color painted metal sides. Bottom and back in the finish of the container <b>HEIGHT:</b> 55,5 cm <b>DEPTH:</b> 46-51,5 cm <b>WIDTH:</b> 60-70-80-90-105-120-140 cm	en panneaux hydrofuges en particules de bois de 16 mm d'épaisseur. Recouvert de papier mélaminé couleur URBAN. Bords ABS de la même couleur Tiroir monté sur coulisses GRASS® pleine extension avec côtés en métal peint couleur URBAN. Fond et retour dans la finition du intérieur <b>HAUTEUR:</b> 55,5 cm <b>PROFONDEUR:</b> 46-51,5 cm <b>LARGEUR:</b> 60-70-80-90-105-120-140 cm	in wasserabweisenden Platten aus 16 mm starken Holzpartikeln. Farb-melaminpapier und ABS Kanten der gleichen Farbe Schublade montiert auf GRASS® Vollauszügen mit URBAN-farbig lackierten Metallseiten. Boden und Rückseite im Abgang des Behälters <b>HÖHE:</b> 55,5 cm <b>TIEFE:</b> 46-51,5 cm <b>BREITE:</b> 60-70-80-90-105-120-140 cm
--	---	---	---

**C frontale / front panel / tiroir / Schublade**

realizzato in pannelli di particelle di legno idrofugo nobilitato con carta melaminica <b>SPESORE:</b> 1,8 cm <b>FINITURE:</b> Laccato OPACO/LUCIDO 48 colori.02 - Nobilitato LEGNO	made of water repellent panels of wood particles <b>THICKNESS:</b> 1,8 cm <b>FINISHES:</b> MATT/GLOSSY Lacquered 48 colori.02 - Nobilitato LEGNO	en panneaux hydrofuges en particules de bois recouvert de papier mélaminé <b>ÉPAISSEUR:</b> 1,8 cm <b>FINITIONS:</b> Laqué MAT/BRILLANT en 48 colori.02 - Nobilitato LEGNO	aus wasserabweisenden Spanplatten, veredelt mit Melaminpapier <b>DICKE:</b> 1,8 cm <b>OBERFLÄCHEN:</b> MATT/HOCHGLANZ Lack aus 48 colori.02 - Nobilitato LEGNO
---	--	--	--

**D apertura / opening system / système d'ouverture / Öffnungssystem**

fascia maniglia in alluminio verniciato	painted alu. handle-profile	profil poignée en aluminium laqué	Griffprofil aus lackiertem Aluminium
---	-----------------------------	-----------------------------------	--------------------------------------

**frontale unico estraibile**  
**single drawer**  
**meuble avec un tiroir**  
**Möbel mit ein Schublade**

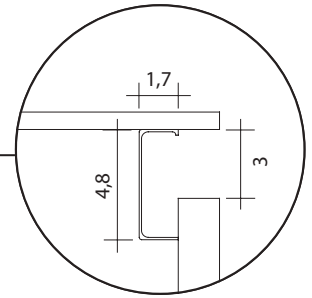
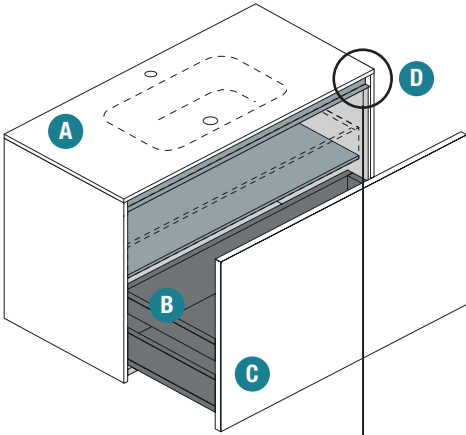

**doppio frontale estraibile**  
**double drawer**  
**meuble avec deux tiroirs**  
**Möbel mit zwei Schubladen**

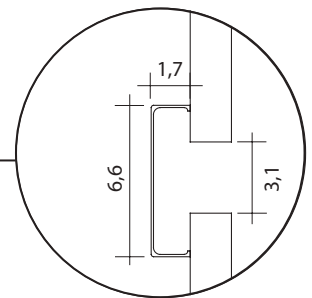
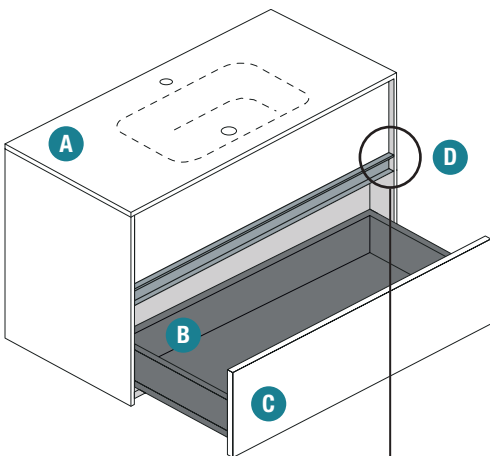

**Nobilitato LEGNO**

pannello di particelle di legno spessore 18 mm idrofugo a basso contenuto di formaldeide nobilitato interno ed esterno con carta melaminica in finitura LEGNO riprodotto ad alta fedeltà; bordo in ABS in finitura

high pressure layered laminate, a perfect and strong imitation of the natural wooden surface

stratifiés décoratifs haute pression. Plaques à base de résines thermoscurissables appelées stratifiés

Hochdruckmehrschichtlaminat mit einer dreidimensionalen Erscheinung

**laccato OPACO / LUCIDO  
MATT / GLOSSY lacquered**

pannello di particelle di legno, idrofugo, a basso contenuto di formaldeide, verniciato con resine poliuretaniche pigmentate opache o lucide

wood particles panel 18 mm with low formaldehyde content, painted with polyurethane resins

**laqué MAT / BRILLANT  
MATT / HOCHGLANZ lackiert**

panneaux de particules de bois 18 mm à faible teneur en formaldéhyde, peint avec des résines de polyuréthane

Holzpartikelplatte 18 mm mit niedrigem Formaldehydgehalt, mit Polyurethanharzen lackiert

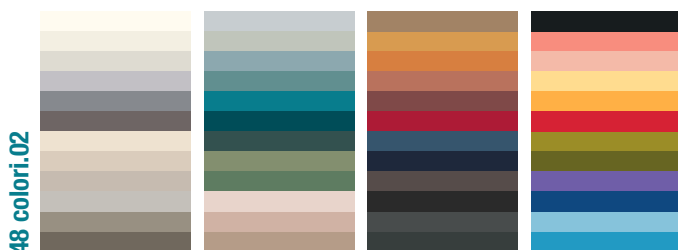

**Fascia maniglia****FINITURE:**

. laccato OPACO 48 **colori.02**  
 . extra pag. 592

**Handle profile****FINISHES:**

. MATT lacquered 48 **colori.02**  
 . extra pag. 592

**Profil poignée****FINITIONS:**

. laqué MAT 48 **colori.02**  
 . extra pag. 592

**Griffprofil****OBERFLÄCHEN:**

. MATT lackiert 48 **colori.02**  
 . extra pag. 592



ALLUMINIO

**abbinamento consigliato mobile/maniglia**  
**combinations furniture/handle**
**coordinations meuble/poignée**  
**Griffeabstimmung**

mobile Nobilitato LEGNO



maniglia laccato OPACO

	<b>12W</b> ABETE BIANCO	
	<b>14W</b> ABETE BROWN	
	<b>26W</b> ABETE ROCCIA	
	<b>27W</b> ABETE FONDENTE	
	<b>31W</b> FRONDA PURO	
	<b>32W</b> FRONDA LIEVE	
	<b>33W</b> FRONDA NUDO	
	<b>34W</b> FRONDA ARCANO	

	<b>01</b> NUDE
	<b>0H</b> CURCUMA
	<b>05</b> WILD
	<b>0U</b> MOCHA
	<b>01</b> NUDE
	<b>0G</b> EARTH
	<b>03</b> NATURE
	<b>59</b> NERO

i colori qui riportati sono da considerarsi indicativi  
 the colours can diverge from the reality  
 la fidélité des couleurs peut être différent de la réalité  
 bitte berücksichtigen Sie unsere Farbfächer zur Farbauswahl

## CASTMARBLE

Filopiano lavabo integrato  
 Integrated plan washbasin  
 Vasque en plan intégrée  
 Integrierte Waschtischplatte



foro rubinetto incl.  
 tap hole incl.  
 trou pour le robinet incl.  
 Armaturbohrung inkl.

provisto di scarico troppopieno  
 with overflow system  
 avec système de trop-plein  
 mit Überlaufsystem

kit piletta e sifone da ordinare separatamente  
 waste kit and siphon to be ordered separately  
 kit bonde d'évacuation et siphon à commander séparément  
 Ablauf Kit und Siphon müssen separat bestellt werden



materiale composito costituito da carbonato di calcio, magnesio e resina poliestere. La finitura superficiale e l'assenza di giunzioni lo rende resistente

special material composed of carbonates, magnesium and polyhedral resins. The surface finish and the absence of joints makes it resistant

matériau spécial composé de alumine et résine acrylique. La finition de surface et l'absence de joints le rendent résistant

Spezialwerkstoff aus Aluminiumoxid und Acrylharz. Die Oberflächenbeschaffenheit und das Fehlen von Gelenken macht es resistent

lavabo integrato  
integrated washbasin  
vasque intégrée  
integriertes Becken



CASBIO

CASBIA

BIANCO OPACO

BIANCO LUCIDO

48 colori.02

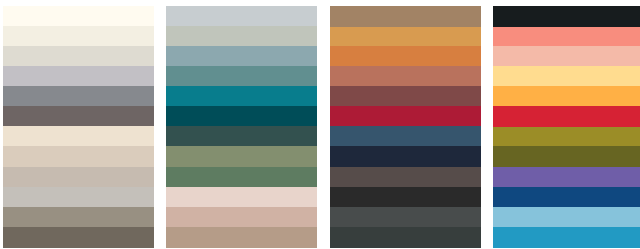

i colori qui riportati sono da considerarsi indicativi  
the colours can diverge from the reality  
la fidélité des couleurs peut être différent de la réalité  
bitte berücksichtigen Sie unsere Farbfächer zur Farbauswahl

**P 46 - H 1,2 cm**

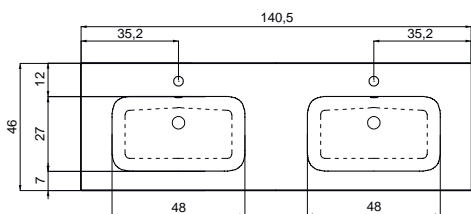
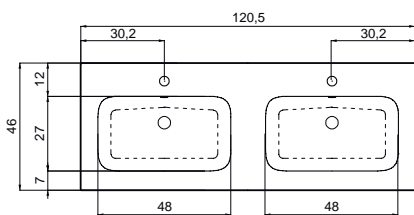
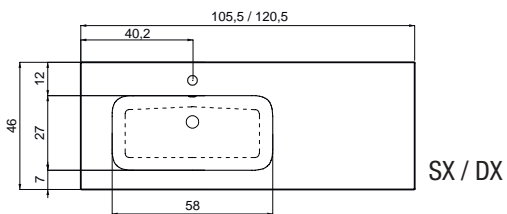
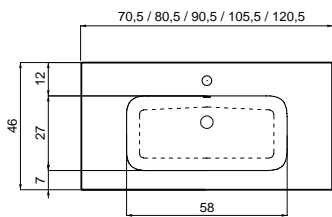
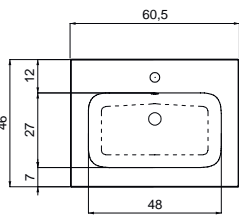
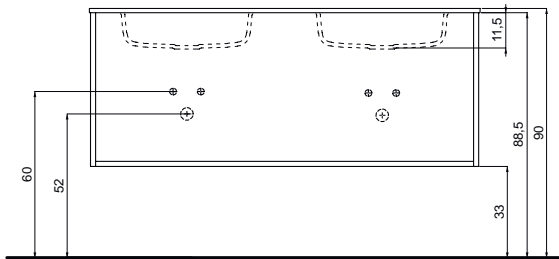

**P 51,5 - H 1,2 cm**

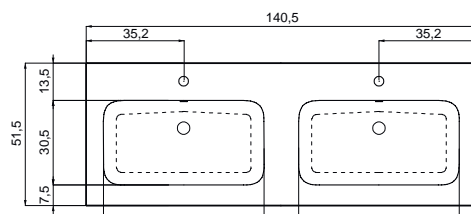
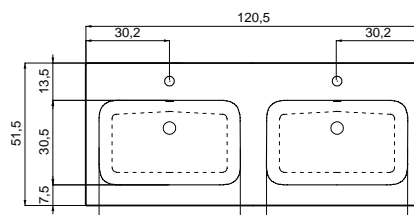
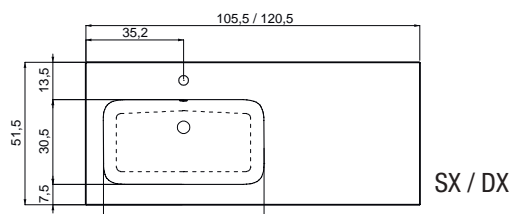
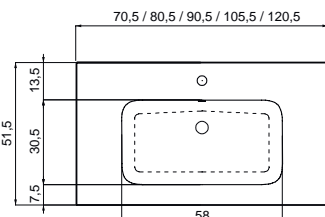
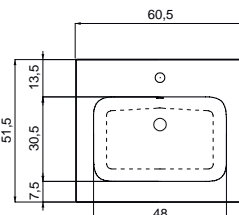
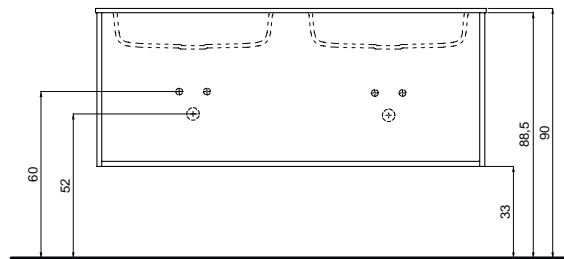

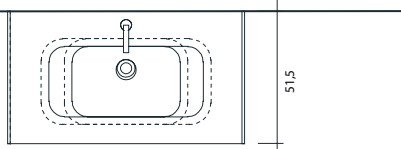
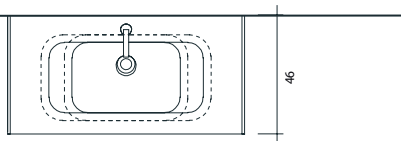
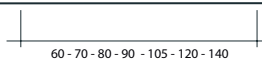
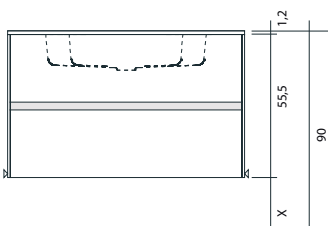
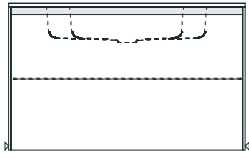
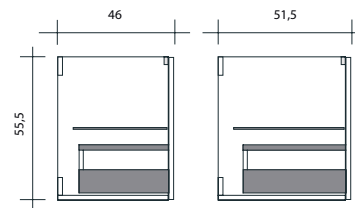

**Modularità**  
**Modularity**

**Modularité**  
**Modularität**

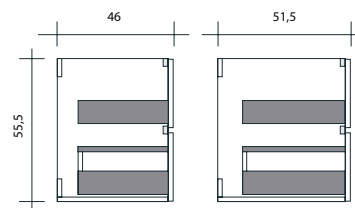
frontale unico estraibile con cassetto, chiusura ammortizzata + 1 ripiano  
 single pull-out, soft-closing + 1 shelf  
 façade amovible avec tiroir + 1 étagère  
 1 Schublade + 1 Regal



doppio frontale estraibile con cassetto, chiusura ammortizzata  
 double soft-closing pull-out  
 2 tiroirs amortis  
 2 Schubladen

Parte tecnica  
Technical section

Section technique  
Technischer Teil

P 46

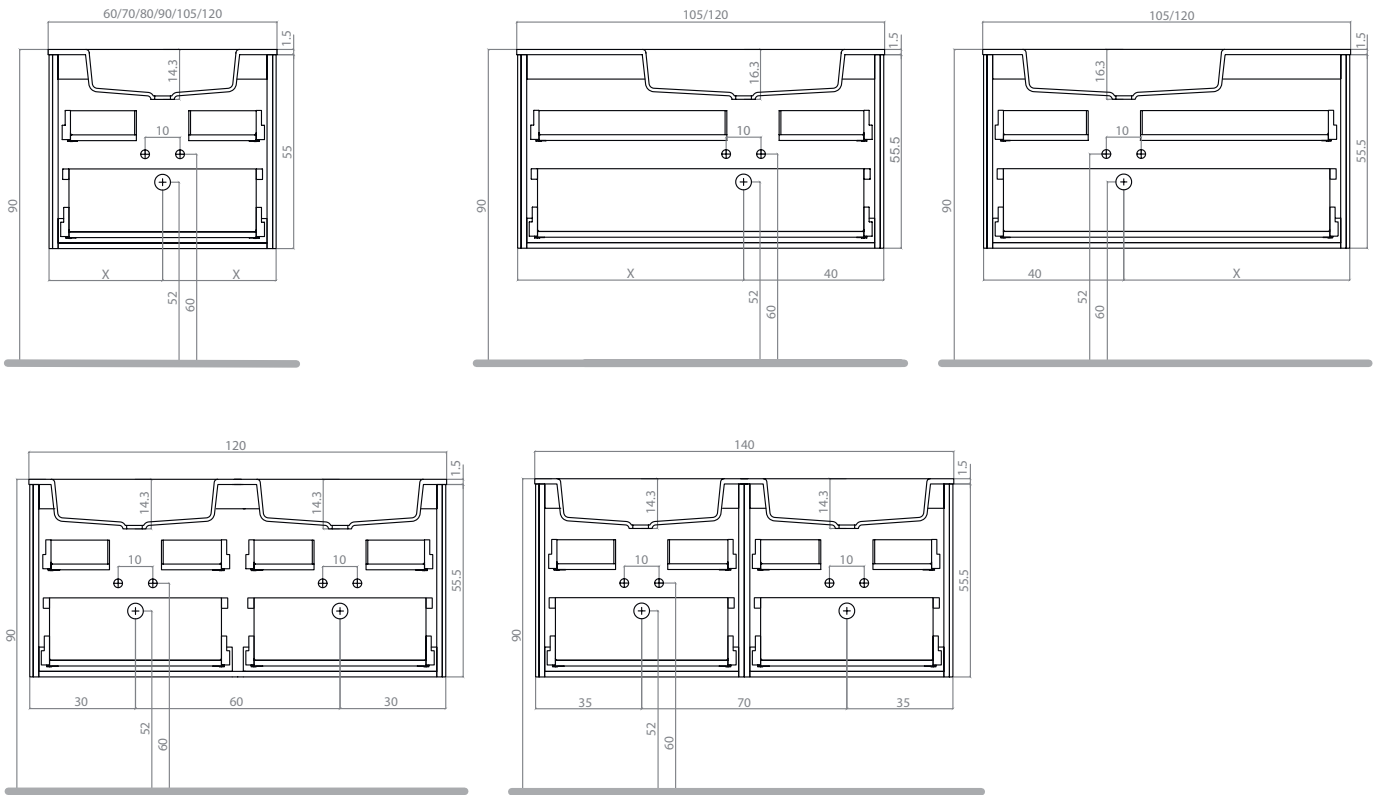

P 51,5

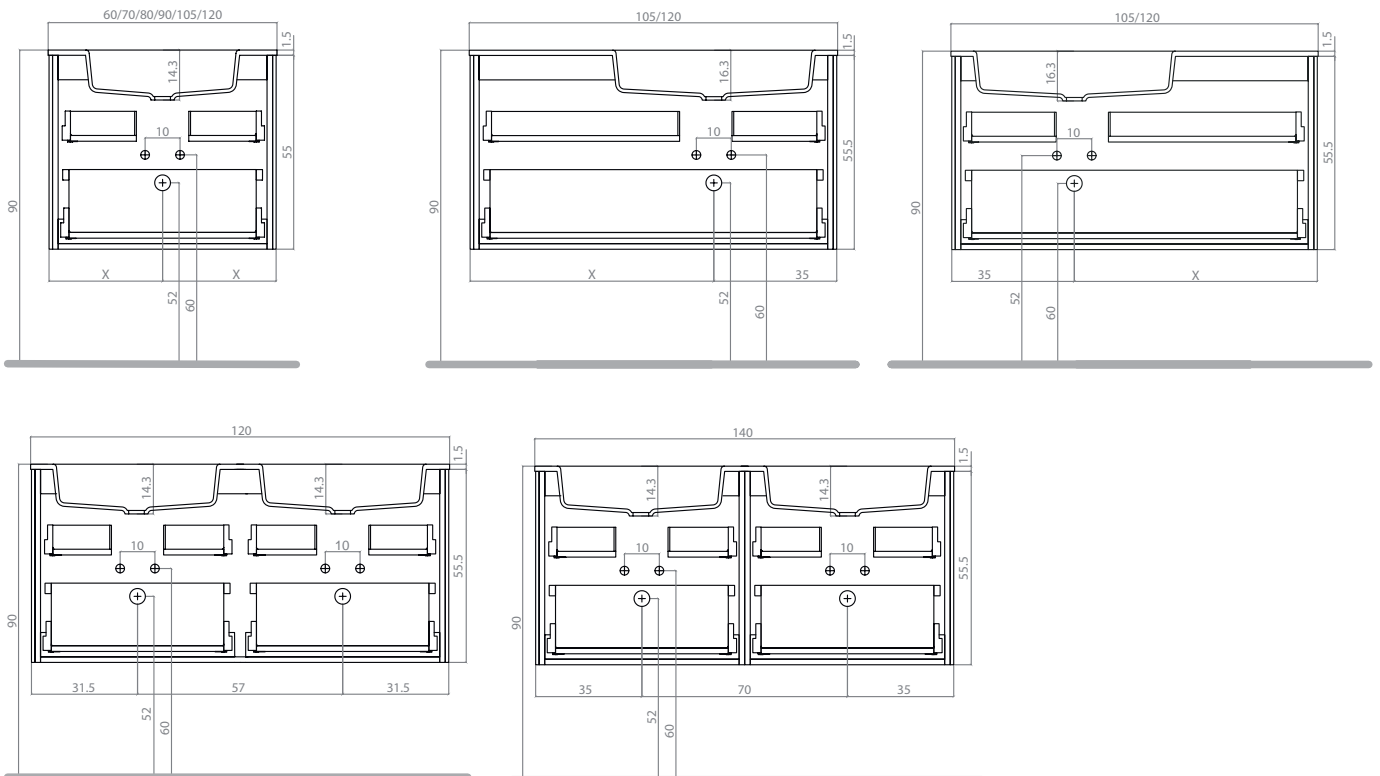



LIBERO base L 140 P 46 Nobilitato legno & castmarble Colori.02  
specchio illuminazione LED integrata L 60 H 75





LIBERO base L 90 P 51,5 Nobilitato legno & castmarble Colori.02  
colonnina Arock®



## Basi con pianolavabo integrato Vanity units with basin

## Meubles avec plan-vasque Waschtischunterschranke

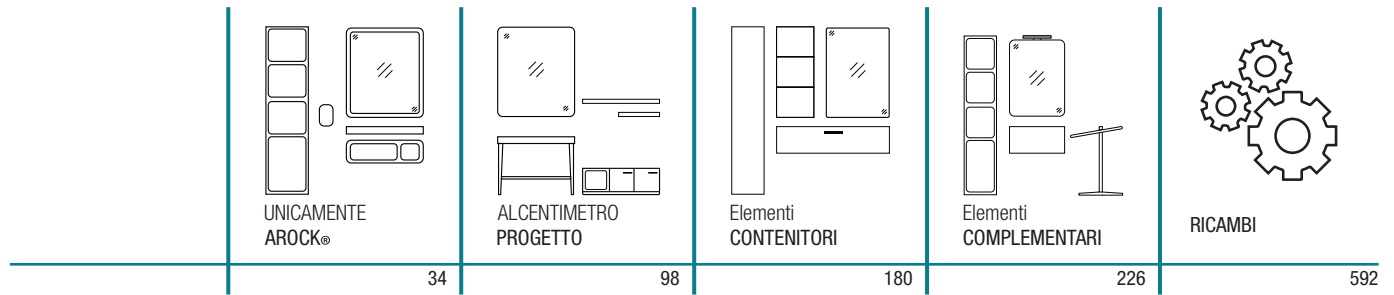

H 55,5

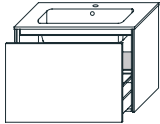

P 46

Castmarble bianco opaco/lucido lavabo centrale • 1 cassetto chiusura ammortizzata + 1 ripiano • sifone incl.  
Vanity unit 1 soft-closing pull-out + 1 shelf & Castmarble white matt/gloss basin set • siphon incl.  
Meuble avec plan-vasque en Castmarble blanc mat/brillant • 1 tiroir amorti + 1 étagère • siphon incl.  
Waschtischunterschrank inkl. 1 Soft-Closing Schublade + 1 Regal & Castmarble weiß Matt/Hochglanz Waschtisch • Siphon inkl.

L		F1	F2	F3
60	MNG060CE			
70	MNG070CE			
80	MNG080CE			
90	MNG090CE			
105	MNG105CE			
120	MNG120CE			

P 51,5

L		F1	F2	F3
60	MNG060CG			
70	MNG070CG			
80	MNG080CG			
90	MNG090CG			
105	MNG105CG			
120	MNG120CG			

H 55,5

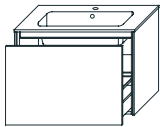

P 46

Castmarble Colori.02 lavabo centrale • 1 cassetto chiusura ammortizzata + 1 ripiano • sifone incl.  
Vanity unit 1 soft-closing pull-out + 1 shelf & Castmarble Colori.02 basin set • siphon incl.  
Meuble avec plan-vasque en Castmarble Colori.02 • 1 tiroir amorti + 1 étagère • siphon incl.  
Waschtischunterschrank inkl. 1 Soft-Closing Schublade + 1 Regal & Castmarble Colori.02 Waschtisch • Siphon inkl.

L		F1	F2	F3
60	MNG060CP			
70	MNG070CP			
80	MNG080CP			
90	MNG090CP			
105	MNG105CP			
120	MNG120CP			

P 51,5

L		F1	F2	F3
60	MNG060CR			
70	MNG070CR			
80	MNG080CR			
90	MNG090CR			
105	MNG105CR			
120	MNG120CR			

H 55,5

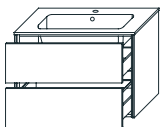

P 46

Castmarble bianco opaco/lucido lavabo centrale • 2 cassetti chiusura ammortizzata • sifone incl.  
Vanity unit 2 soft-closing pull-out & Castmarble white matt/gloss basin set • siphon incl.  
Meuble avec plan-vasque en Castmarble blanc mat/brillant • 2 tiroirs amortis • siphon incl.  
Waschtischunterschrank inkl. 2 Soft-Closing Schubladen & Castmarble weiß Matt/Hochglanz Waschtisch • Siphon inkl.

L		F1	F2	F3
60	MNS060CA			
70	MNS070CA			
80	MNS080CA			
90	MNS090CA			
105	MNS105CA			
120	MNS120CA			

P 51,5

L		F1	F2	F3
60	MNS060CC			
70	MNS070CC			
80	MNS080CC			
90	MNS090CC			
105	MNS105CC			
120	MNS120CC			

H  
L  
P

Misure in cm  
Measures in cm  
Mesures en cm  
Maße in cm

**F1** Laccato opaco  
Matt lacquered  
Laqué mat  
Matt lackiert

**F2** Laccato lucido  
Glossy lacquered  
Laqué brillant  
Hochglanz lackiert

**F3** Nobilitati  
Veneer wood  
Placage bois  
Beschichtetes Holz

**F4** Arock®  
Arock®  
Arock®  
Arock®

**F5** abitat / vogue  
abitat / vogue  
abitat / vogue  
abitat / vogue

## Basi con pianolavabo integrato Vanity units with basin

## Meubles avec plan-vasque Waschtischunterschranke

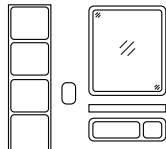

UNICAMENTE  
AROCK®

34



ALCENTIMETRO  
PROGETTO

98

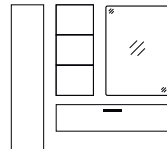

Elementi  
CONTENITORI

180

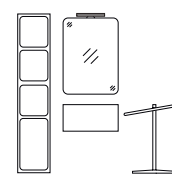

Elementi  
COMPLEMENTARI

226



RICAMBI

592

### H 55,5

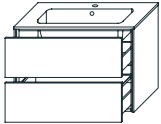

### P 46

Castmarble Colori.02 lavabo centrale • 2 cassetti chiusura ammortizzata • sifone incl.  
Vanity unit 2 soft-closing pull-out & Castmarble Colori.02 basin set • siphon incl.  
Meuble avec plan-vasque en Castmarble Colori.02 • 2 tiroirs amortis • siphon incl.  
Waschtischunterschrank inkl. 2 Soft-Closing Schubladen & Castmarble Colori.02 Waschtisch • Siphon inkl.

L		F1	F2	F3
60	MNS060CP			
70	MNS070CP			
80	MNS080CP			
90	MNS090CP			
105	MNS105CP			
120	MNS120CP			

### P 51,5

L		F1	F2	F3
60	MNS060CR			
70	MNS070CR			
80	MNS080CR			
90	MNS090CR			
105	MNS105CR			
120	MNS120CR			

### H 55,5

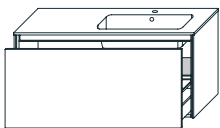

### P 46

Castmarble bianco opaco/lucido lavabo dx • 1 cassetto chiusura ammortizzata + 1 ripiano • sifone incl.  
Vanity unit 1 soft-closing pull-out + 1 shelf & Castmarble white matt/gloss basin set • siphon incl.  
Meuble avec plan-vasque en Castmarble blanc mat/brillant • 1 tiroir amorti + 1 étagère • siphon incl.  
Waschtischunterschrank inkl. 1 Soft-Closing Schublade + 1 Regal & Castmarble weiß Matt/Hochglanz Waschtisch • Siphon inkl.

L		F1	F2	F3
105	MNG105DE			
120	MNG120DE			

### P 51,5

L		F1	F2	F3
105	MNG105DG			
120	MNG120DG			

### H 55,5

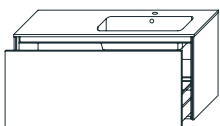

### P 46

Castmarble Colori.02 lavabo dx • 1 cassetto chiusura ammortizzata + 1 ripiano • sifone incl.  
Vanity unit 1 soft-closing pull-out + 1 shelf & Castmarble Colori.02 basin set • siphon incl.  
Meuble avec plan-vasque en Castmarble Colori.02 • 1 tiroir amorti + 1 étagère • siphon incl.  
Waschtischunterschrank inkl. 1 Soft-Closing Schublade + 1 Regal & Castmarble Colori.02 Waschtisch • Siphon inkl.

L		F1	F2	F3
105	MNG105DP			
120	MNG120DP			

### P 51,5

L		F1	F2	F3
105	MNG105DR			
120	MNG120DR			

H  
L  
P

Misure in cm  
Measures in cm  
Mesures en cm  
Maße in cm

**F1** Laccato opaco  
Matt lacquered  
Laqué mat  
Matt lackiert

**F2** Laccato lucido  
Glossy lacquered  
Laqué brillant  
Hochglanz lackiert

**F3** Nobilitati  
Veneer wood  
Placage bois  
Beschichtetes Holz

**F4** Arock®  
Arock®  
Arock®  
Arock®

**F5** abitat / vogue  
abitat / vogue  
abitat / vogue  
abitat / vogue

## Basi con pianolavabo integrato Vanity units with basin

## Meubles avec plan-vasque Waschtischunterschänke

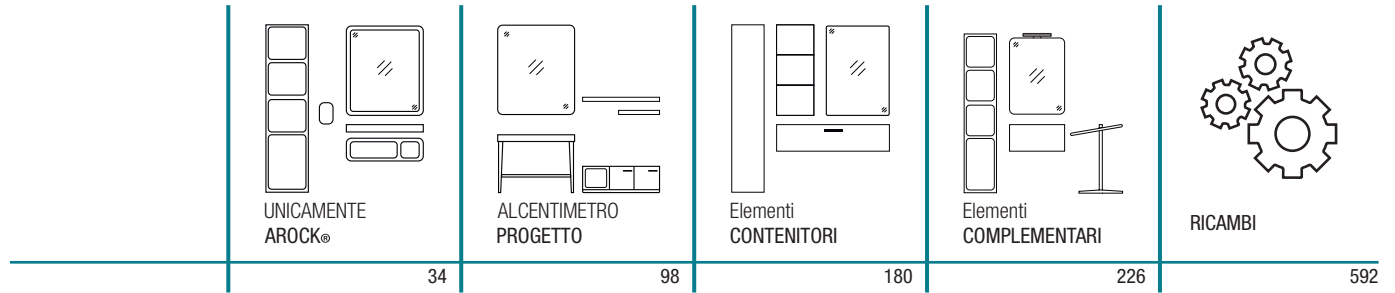

### H 55,5

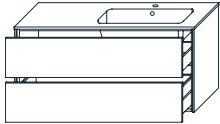

### P 46

Castmarble bianco opaco/lucido lavabo dx • 2 cassetti chiusura ammortizzata • sifone incl.  
Vanity unit 2 soft-closing pull-out & Castmarble white matt/gloss basin set • siphon incl.  
Meuble avec plan-vasque en Castmarble blanc mat/brillant • 2 tiroirs amortis • siphon incl.  
Waschtischunterschrank inkl. 2 Soft-Closing Schubladen & Castmarble weiß Matt/Hochglanz Waschtisch • Siphon inkl.

L		F1	F2	F3
105	MNS105DA			
120	MNS120DA			

### P 51,5

L		F1	F2	F3
105	MNS105DC			
120	MNS120DC			

### H 55,5

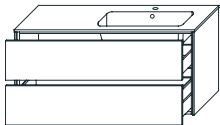

### P 46

Castmarble Colori.02 lavabo dx • 2 cassetti chiusura ammortizzata • sifone incl.  
Vanity unit 2 soft-closing pull-out & Castmarble Colori.02 basin set • siphon incl.  
Meuble avec plan-vasque en Castmarble Colori.02 • 2 tiroirs amortis • siphon incl.  
Waschtischunterschrank inkl. 2 Soft-Closing Schubladen & Castmarble Colori.02 Waschtisch • Siphon inkl.

L		F1	F2	F3
105	MNS105DP			
120	MNS120DP			

### P 51,5

L		F1	F2	F3
105	MNS105DR			
120	MNS120DR			

### H 55,5

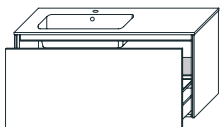

### P 46

Castmarble bianco opaco/lucido lavabo sx • 1 cassetto chiusura ammortizzata + 1 ripiano • sifone incl.  
Vanity unit 1 soft-closing pull-out + 1 shelf & Castmarble white matt/gloss basin set • siphon incl.  
Meuble avec plan-vasque en Castmarble blanc mat/brillant • 1 tiroir amorti + 1 étagère • siphon incl.  
Waschtischunterschrank inkl. 1 Soft-Closing Schublade + 1 Regal & Castmarble weiß Matt/Hochglanz Waschtisch • Siphon inkl.

L		F1	F2	F3
105	MNG105SE			
120	MNG120SE			

### P 51,5

L		F1	F2	F3
105	MNG105SG			
120	MNG120SG			

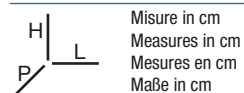

**F1** Laccato opaco  
Matt lacquered  
Laqué mat  
Matt lackiert

**F2** Laccato lucido  
Glossy lacquered  
Laqué brillant  
Hochglanz lackiert

**F3** Nobilitati  
Veneer wood  
Placage bois  
Beschichtetes Holz

**F4** Arock®  
Arock®  
Arock®  
Arock®

**F5** abitat / vogue  
abitat / vogue  
abitat / vogue  
abitat / vogue

## Basi con pianolavabo integrato Vanity units with basin

## Meubles avec plan-vasque Waschtischunterschranke

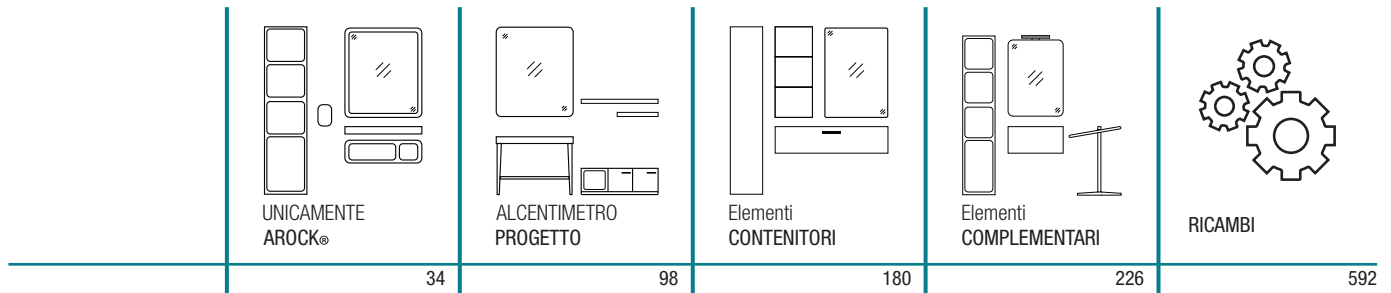
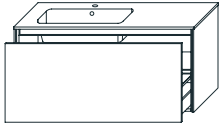

**H 55,5**

**P 46**

Castmarble Colori.02 lavabo sx • 1 cassetto chiusura ammortizzata + 1 ripiano • sifone incl.  
Vanity unit 1 soft-closing pull-out + 1 shelf & Castmarble Colori.02 basin set • siphon incl.  
Meuble avec plan-vasque en Castmarble Colori.02 • 1 tiroir amorti + 1 étagère • siphon incl.  
Waschtischunterschrank inkl. 1 Soft-Closing Schublade + 1 Regal & Castmarble Colori.02 Waschtisch • Siphon inkl.

L		F1	F2	F3
105	MNG105SP			
120	MNG120SP			

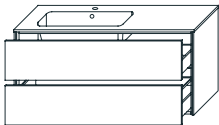
**P 51,5**

L		F1	F2	F3
105	MNG105SR			
120	MNG120SR			

**H 55,5**

**P 46**

Castmarble bianco opaco/lucido lavabo sx • 2 cassetti chiusura ammortizzata • sifone incl.  
Vanity unit 2 soft-closing pull-out & Castmarble white matt/gloss basin set • siphon incl.  
Meuble avec plan-vasque en Castmarble blanc mat/brillant • 2 tiroirs amortis • siphon incl.  
Waschtischunterschrank inkl. 2 Soft-Closing Schubladen & Castmarble weiß Matt/Hochglanz Waschtisch • Siphon inkl.

L		F1	F2	F3
105	MNS105SA			
120	MNS120SA			

**P 51,5**

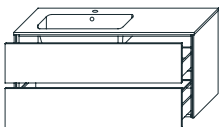
L		F1	F2	F3
105	MNS105SR			
120	MNS120SR			

**H 55,5**

**P 46**

Castmarble Colori.02 lavabo sx • 2 cassetti chiusura ammortizzata • sifone incl.  
Vanity unit 2 soft-closing pull-out & Castmarble Colori.02 basin set • siphon incl.  
Meuble avec plan-vasque en Castmarble Colori.02 • 2 tiroirs amortis • siphon incl.  
Waschtischunterschrank inkl. 2 Soft-Closing Schubladen & Castmarble Colori.02 Waschtisch • Siphon inkl.

L		F1	F2	F3
105	MNS105SP			
120	MNS120SP			

**P 51,5**

L		F1	F2	F3
105	MNS105SR			
120	MNS120SR		5	

H  
L  
P

Misure in cm  
Measures in cm  
Mesures en cm  
Maße in cm

**F1** Laccato opaco  
Matt lacquered  
Laqué mat  
Matt lackiert

**F2** Laccato lucido  
Glossy lacquered  
Laqué brillant  
Hochglanz lackiert

**F3** Nobilitati  
Veneer wood  
Placage bois  
Beschichtetes Holz

**F4** Arock®  
Arock®  
Arock®  
Arock®

**F5** abitat / vogue  
abitat / vogue  
abitat / vogue  
abitat / vogue

## Basi con pianolavabo integrato Vanity units with basin

## Meubles avec plan-vasque Waschtischunterschranke

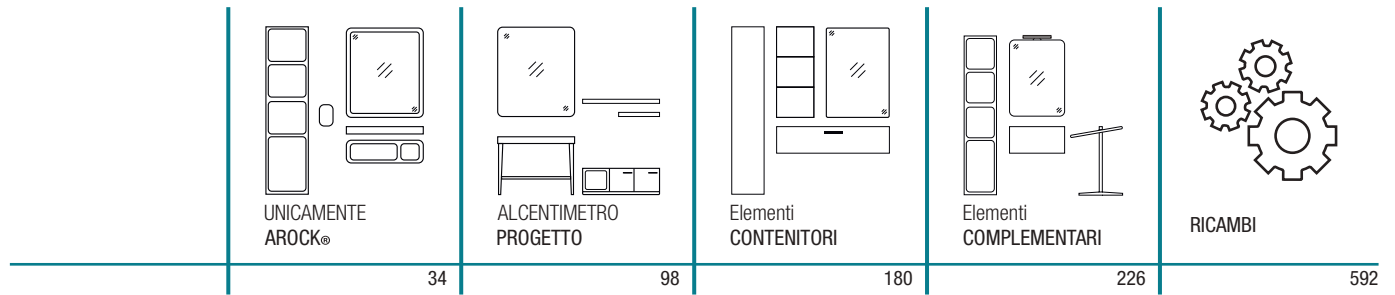
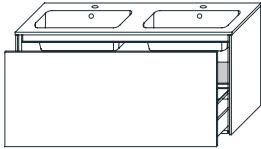
**H 55,5**

**P 46**

Castmarble bianco opaco/lucido lavabo doppio • 1 cassetto chiusura ammortizzata + 1 ripiano • sifone incl.  
Vanity unit 1 soft-closing pull-out + 1 shelf & Castmarble white matt/gloss basin set • siphon incl.  
Meuble avec plan-vasque en Castmarble blanc mat/brillant • 1 tiroir amorti + 1 étagère • siphon incl.  
Waschtischunterschrank inkl. 1 Soft-Closing Schublade + 1 Regal & Castmarble weiß Matt/Hochglanz Waschtisch • Siphon inkl.

**L** 120 MNG120TE

**F1** **F2** **F3**

**P 51,5**

**L** 120 MNG120TG

**F1** **F2** **F3**

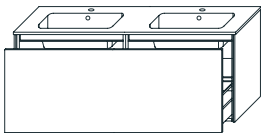
**H 55,5**

**P 46**

Castmarble Colori.02 lavabo doppio • 1 cassetto chiusura ammortizzata + 1 ripiano • sifone incl.  
Vanity unit 1 soft-closing pull-out + 1 shelf & Castmarble Colori.02 basin set • siphon incl.  
Meuble avec plan-vasque en Castmarble Colori.02 • 1 tiroir amorti + 1 étagère • siphon incl.  
Waschtischunterschrank inkl. 1 Soft-Closing Schublade + 1 Regal & Castmarble Colori.02 Waschtisch • Siphon inkl.

**L** 120 MNG120TP

**F1** **F2** **F3**

**P 51,5**

**L** 120 MNG120TR

**F1** **F2** **F3**

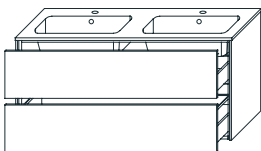
**H 55,5**

**P 46**

Castmarble bianco opaco/lucido lavabo doppio • 2 cassetti chiusura ammortizzata • sifone incl.  
Vanity unit 2 soft-closing pull-out & Castmarble white matt/gloss basin set • siphon incl.  
Meuble avec plan-vasque en Castmarble blanc mat/brillant • 2 tiroirs amortis • siphon incl.  
Waschtischunterschrank inkl. 2 Soft-Closing Schubladen & Castmarble weiß Matt/Hochglanz Waschtisch • Siphon inkl.

**L** 120 MNS120TA

**F1** **F2** **F3**

**P 51,5**

**L** 120 MNS120TC

**F1** **F2** **F3**

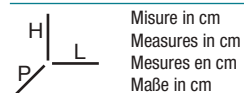

Misure in cm  
Measures in cm  
Mesures en cm  
Maße in cm

**F1** Laccato opaco  
Matt lacquered  
Laqué mat  
Matt lackiert

**F2** Laccato lucido  
Glossy lacquered  
Laqué brillant  
Hochglanz lackiert

**F3** Nobilitati  
Veneer wood  
Placage bois  
Beschichtetes Holz

**F4** Arock®  
Arock®  
Arock®  
Arock®

**F5** abitat / vogue  
abitat / vogue  
abitat / vogue  
abitat / vogue

## Basi con pianolavabo integrato Vanity units with basin

## Meubles avec plan-vasque Waschtischunterschranke

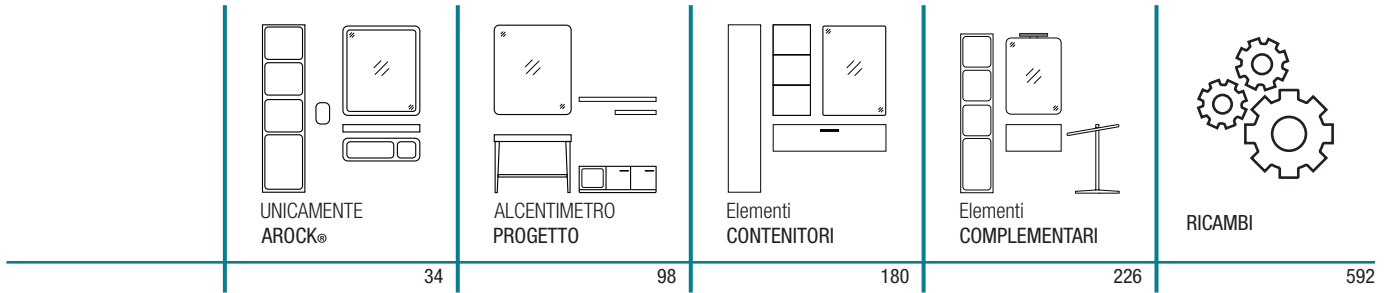
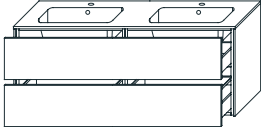

**H 55,5**

**P 46**

Castmarble Colori.02 lavabo doppio • 2 cassetti chiusura ammortizzata • sifone incl.  
Vanity unit 2 soft-closing pull-out & Castmarble Colori.02 basin set • siphon incl.  
Meuble avec plan-vasque en Castmarble Colori.02 • 2 tiroirs amortis • siphon incl.  
Waschtischunterschrank inkl. 2 Soft-Closing Schubladen & Castmarble Colori.02 Waschtisch • Siphon inkl.

L 120 MNS120TP

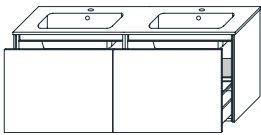
**F1**
**F2**
**F3**
**P 51,5**

L 120 MNS120TR

**F1**
**F2**
**F3**
**H 55,5**

**P 46**

Castmarble bianco opaco/lucido lavabo doppio • 2 cassetti chiusura ammortizzata + 2 ripiani • sifone incl.  
Vanity unit 2 soft-closing pull-out + 2 shelves & Castmarble white matt/gloss basin set • siphon incl.  
Meuble avec plan-vasque en Castmarble blanc mat/brillant • 2 tiroirs amortis + 2 étagères • siphon incl.  
Waschtischunterschrank inkl. 2 Soft-Closing Schubladen + 2 Regale & Castmarble weiß Matt/Hochglanz Waschtisch • Siphon inkl.

L 140 MNG140TE

**F1**
**F2**
**F3**
**P 51,5**

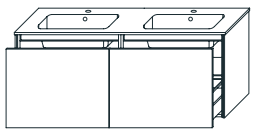
L 140 MNG140TG

**F1**
**F2**
**F3**
**H 55,5**

**P 46**

Castmarble Colori.02 lavabo doppio • 2 cassetti chiusura ammortizzata + 2 ripiani • sifone incl.  
Vanity unit 2 soft-closing pull-out + 2 shelves & Castmarble Colori.02 basin set • siphon incl.  
Meuble avec plan-vasque en Castmarble Colori.02 • 2 tiroirs amortis + 2 étagères • siphon incl.  
Waschtischunterschrank inkl. 2 Soft-Closing Schubladen + 2 Regale & Castmarble Colori.02 Waschtisch • Siphon inkl.

L 140 MNG140TP

**F1**
**F2**
**F3**
**P 51,5**

L 140 MNG140TR

**F1**
**F2**
**F3**

H  
L  
P

Misure in cm  
Measures in cm  
Mesures en cm  
Maße in cm

**F1** Laccato opaco  
Matt lacquered  
Laqué mat  
Matt lackiert

**F2** Laccato lucido  
Glossy lacquered  
Laqué brillant  
Hochglanz lackiert

**F3** Nobilitati  
Veneer wood  
Placage bois  
Beschichtetes Holz

**F4** Arock®  
Arock®  
Arock®  
Arock®

**F5** abitat / vogue  
abitat / vogue  
abitat / vogue  
abitat / vogue

## Basi con pianolavabo integrato Vanity units with basin

## Meubles avec plan-vasque Waschtischunterschranke

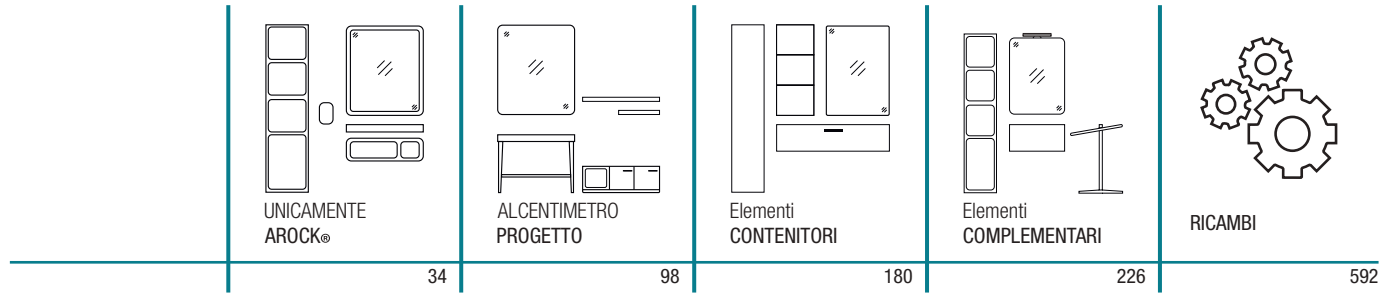
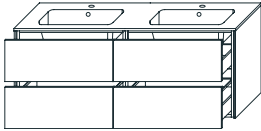
**H 55,5**

**P 46**

Castmarble bianco opaco/lucido lavabo doppio • 4 cassetti chiusura ammortizzata • sifone incl.  
Vanity unit 4 soft-closing pull-out & Castmarble white matt/gloss basin set • siphon incl.  
Meuble avec plan-vasque en Castmarble blanc mat/brillant • 4 tiroirs amortis • siphon incl.  
Waschtischunterschrank inkl. 4 Soft-Closing Schubladen & Castmarble weiß Matt/Hochglanz Waschtisch • Siphon inkl.

L 140 MNS140TA

F1 F2 F3

**P 51,5**

L 140 MNS140TC

F1 F2 F3

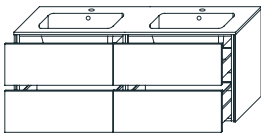
**H 55,5**

**P 46**

Castmarble Colori.02 lavabo doppio • 4 cassetti chiusura ammortizzata • sifone incl.  
Vanity unit 4 soft-closing pull-out & Castmarble Colori.02 basin set • siphon incl.  
Meuble avec plan-vasque en Castmarble Color.02 • 4 tiroirs amortis • siphon incl.  
Waschtischunterschrank inkl. 4 Soft-Closing Schubladen & Castmarble Colori.02 Waschtisch • Siphon inkl.

L 140 MNS140TP

F1 F2 F3

**P 51,5**

L 140 MNS140TR

F1 F2 F3

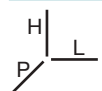

Misure in cm  
Measures in cm  
Mesures en cm  
Maße in cm

**F1** Laccato opaco  
Matt lacquered  
Laqué mat  
Matt lackiert

**F2** Laccato lucido  
Glossy lacquered  
Laqué brillant  
Hochglanz lackiert

**F3** Nobilitati  
Veneer wood  
Placage bois  
Beschichtetes Holz

**F4** Arock®  
Arock®  
Arock®  
Arock®

**F5** abitat / vogue  
abitat / vogue  
abitat / vogue  
abitat / vogue







LIBERO base L 140 P 51,5 laccato opaco & castmarble bianco opaco  
specchio AERO L 160 H 50  
lampada Kenobi L 120  
pomolo Arock®  
mensola Arock® L 53 H 17

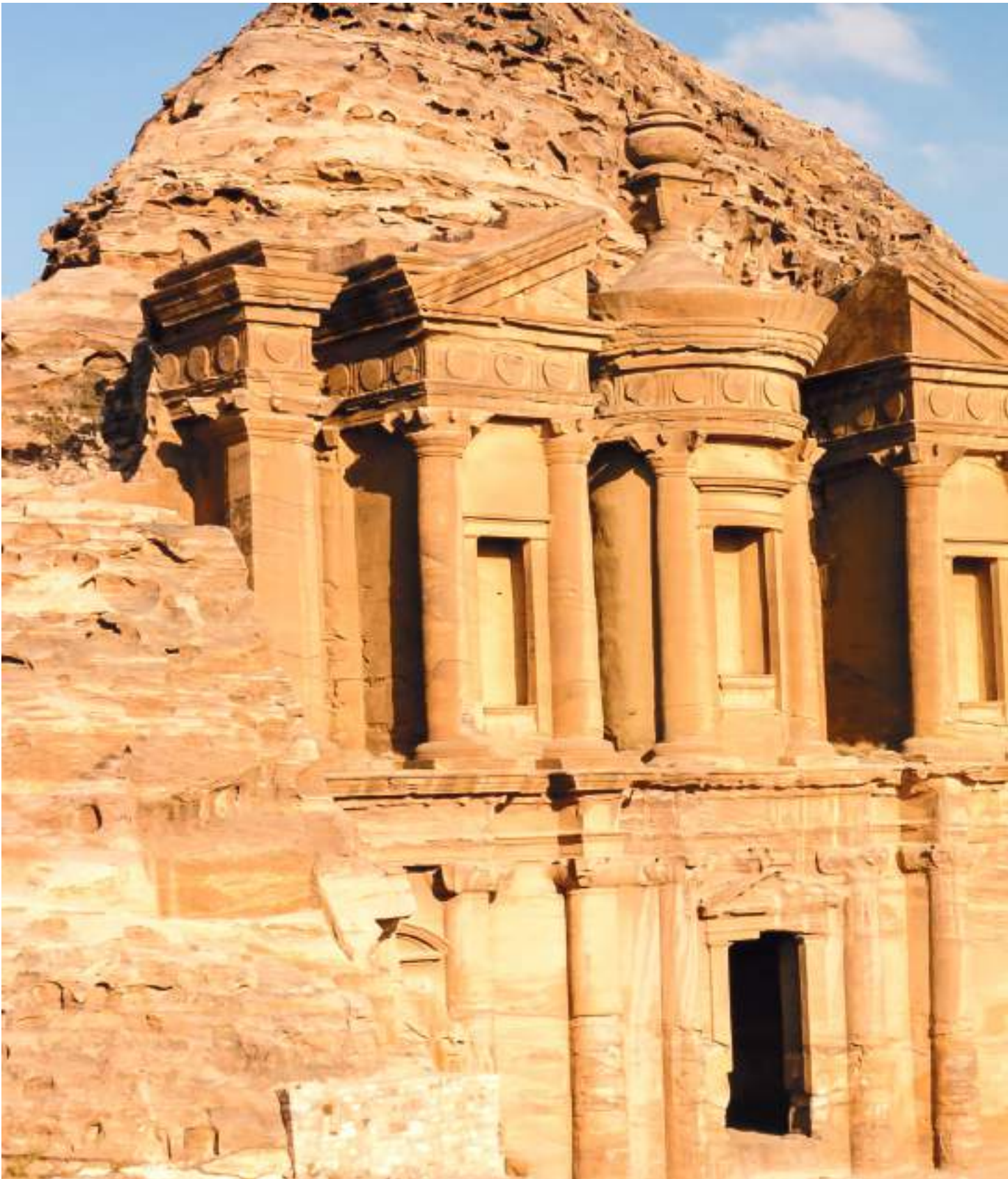

Petra (roccia in greco) è un sito archeologico della Giordania, posto a circa 250 km a sud della capitale Amman, abbandonato verso l'VIII secolo e rivelato al mondo Occidentale nel 1812. Le numerose facciate intagliate nella roccia, riferibili per la massima parte a sepolcri, ne fanno un monumento unico dichiarato patrimonio dell'umanità dall'UNESCO nel 1985 e una delle Sette Meraviglie del Mondo Moderno nel 2007





Petra (rock in Greek) is an archaeological site in Jordan. It is located approximately at 250 km from the South of the capital, Amman. In the VIII century Petra was abandoned and in 1812 the archaeological site was revealed to the Western world. The numerous carved facades of the rock, which, generally, can be related to sepulchers, make it a unique monument. In 1985, Petra was announced by UNESCO heritage of the humanity. In addition, in 2007, Petra was declared one of the Modern World's Seven Wonders





MOBILI componibili

**LEALE**



# L E A L E

un programma componibile per la progettazione dell'ambiente bagno e la rappresentazione di ogni stile di vita

una notevole varietà di aperture, misure, colori e materiali consente innumerevoli combinazioni per stimolare la capacità progettuale di venditori e clienti

i molteplici lavabi e complementi abbinabili esaltano le forme e gli abbinamenti di questa serie

une série modulaire pour la conception de chaque environnement et la satisfaction de chaque style de vie

une remarquable variété d'ouvertures, de dimensions et de matériaux permet beaucoup de combinaisons pour les clients qui souhaitent personnaliser leur salle de bain

l'offre de multiples formes de lavabos complète cette proposition utile





a modular program for the design of every environment and every lifestyle's satisfaction

a remarkable variety of openings, sizes, and materials enables the use of countless combinations for clients/users who want to customize their bathroom

the offer of multiple basin and complements, to be combined with, enhances the shapes and designs of this magical proposal

ein modulares Programm für die Gestaltung jeder Umgebung und die Zufriedenheit jedes Lebensstils

eine bemerkenswerte Vielfalt an Öffnungen, Größen und Materialien ermöglicht unzählige Kombinationen für Kunden, die ihr Bad individuell gestalten möchten

das Angebot von mehreren Waschtischformen rundet diesen hilfreichen Vorschlag ab

**A** piano / top / plan / Platte

## TIPOLOGIE:

filopiano lavabo integrato;  
per lavabo sopra piano da appoggio e  
da incasso e sottopiano da incasso  
PROFONDITA': 45-51,5 cm  
FINITURE: Arock® - HPL - Nobilitato  
LEGNO/ALTATTO - Laccato OPACO/  
LUCIDO - GRES - PIETRA NATURALE -  
SILESTONE - CRISTALLO

## TYPES:

integrated plan washbasin;  
for countertop basin, recessed basin  
and undermounted basin  
DEPTH: 45-51.5 cm  
FINISHES: Arock® - HPL - Nobilitato  
LEGNO/ALTATTO - Laquered MATT/  
GLOSSY - GRES - NATURAL STONE -  
SILESTONE

## TYPOLOGIES:

lavabo intégré au plan;  
pour lavabo à poser, lavabo encastré  
surélevé et lavabo encastré  
PROFONDEUR: 45-51,5 cm  
FINITIONS: Arock® - HPL - Mé laminé  
BOIS/ALTATTO - Laque MAT/BRIL-  
LANT - GRES - PIERRE NATURELLE  
- SILESTONE

## TYPOLOGIEN:

integriertes Waschbecken;  
für Aufsatzwaschtisch, Halbeinbau-  
becken und Einbauwaschtisch  
TIEFE: 45-51,5 cm  
AUSFÜHRUNGEN: Arock® - HPL -  
Melamin HOLZ ALTATTO - MATT/  
HOCHGLANZ Lack - GRES - NATUR-  
STEIN - SILESTONE

**B** contenitore / interior configuration / configuration intérieure / Innenausstattung

realizzato in pannelli di particelle di  
legno di spessore 18 mm, idrofughi,  
nobilitato con carta melaminica colo-  
re URBAN. Bordi in ABS in tinta.  
Cassetto montato su guide GRASS®  
ad estrazione totale con sponde  
laterali in metallo verniciato colore  
URBAN. Fondo e schienale nella  
finitura del contenitore  
zoccolo H 12 cm in PVC  
ALTEZZA : 25-40-50-75 cm  
PROFONDITA': 45-51,5 cm  
LARGHEZZA: 30-35-45-60-70-  
80-90-105-120 cm

made of water repellent panels of 18  
mm thick wood particles, covered  
with Nobilitato URBAN color.  
Matching ABS edges  
Drawer mounted on full extension  
GRASS® runners with URBAN color  
painted metal sides. Bottom and back  
in the finish of the container  
Toe-kick H 12 cm in PVC  
HEIGHT: 25-40-50-75 cm  
DEPTH: 45-51,5 cm  
WIDTH: 30-35-45-60-70-90-105-  
120 cm

en panneaux hydrofuges en particu-  
les de bois de 18 mm d'épaisseur.  
Recouvert de papier mélaminé  
couleur URBAN. Bords ABS de la  
même couleur  
Tiroir monté sur coulisses GRASS®  
pleine extension avec côtés en métal  
peint couleur URBAN. Fond et retour  
dans la finition du intérieur  
Socle H 12 cm en PVC  
HAUTEUR: 25-40-50-75 cm  
PROFONDEUR: 45-51,5 cm  
LARGEUR: 30-35-45-60-70-90-105-  
120 cm

in wasserabweisenden Platten aus  
18 mm starken Holzpartikeln. Farb-  
melaminpapier und ABS Kanten der  
gleichen Farbe  
Schublade montiert auf GRASS®  
Vollauszügen mit URBAN-farbig  
lackierten Metallseiten. Boden und  
Rückseite im Abgang des Behälters  
Sockel H 12 cm aus PVC  
HÖHE: 25-40-50-75 cm  
TIEFE: 45-51,5 cm  
BREITE: 30-35-45-60-70-90-105-  
120 cm

**C** frontali / front panels / tiroirs / Schublade

realizzato in pannelli di particelle di  
legno idrofugo nobilitato con carta  
melaminica  
SPESSORE: 1,8 cm  
FINITURE: Laccato OPACO/LUCIDO 48  
colori.02 - Nobilitato LEGNO

made of water repellent panels of  
wood particles  
THICKNESS: 1,8 cm  
FINISHES: MATT/GLOSSY Lacquered  
48 colori.02 - Nobilitato LEGNO

en panneaux hydrofuges en particules  
de bois recouvert de papier mélaminé  
ÉPAISSEUR: 1,8 cm  
FINITIONS: Laqué MAT/BRILLANT en  
48 colori.02 - Nobilitato LEGNO

aus wasserabweisenden Spanplatten,  
veredelt mit Melaminpapier  
DICKE: 1,8 cm  
OBERFLÄCHEN: MATT/HOCHGLANZ  
Lack aus 48 colori.02 - Nobilitato  
LEGNO

**D** apertura / opening system / système d'ouverture / Öffnungssystem

Maniglia FILO / Maniglia PONTE /  
Smusso 45° / Sistema Premi-Apri

FILO Handle / PONTE Handle /  
Smusso 45° / Premi-Apri System

Poignée FILO / Poignée PONTE /  
Smusso 45° / Système Premi-Apri

FILO Griff / PONTE Griff /  
Smusso 45° / Premi-Apri System



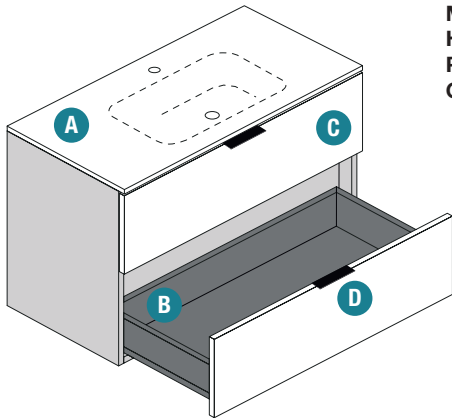

**Maniglia FILO - L 20 cm**  
**Handle FILO**  
**Poignée FILO**  
**Griffe FILO**

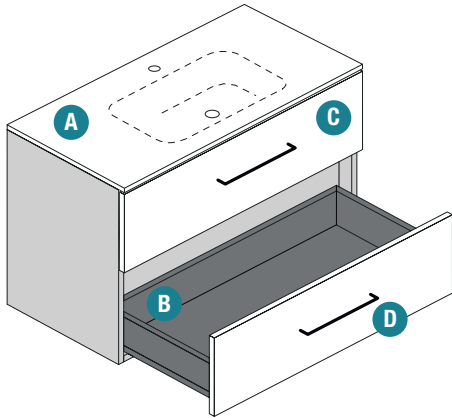

**Maniglia PONTE - L 20,5 / 33 cm**  
**Handle PONTE**  
**Poignée PONTE**  
**Griffe PONTE**

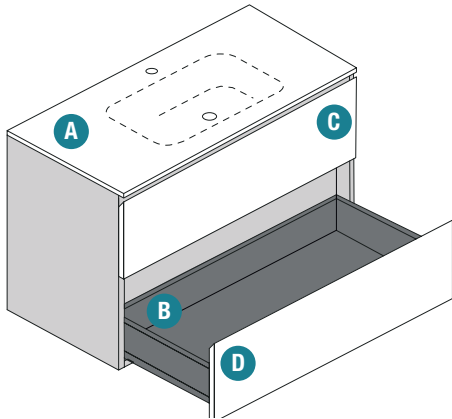

**Smusso 45°**

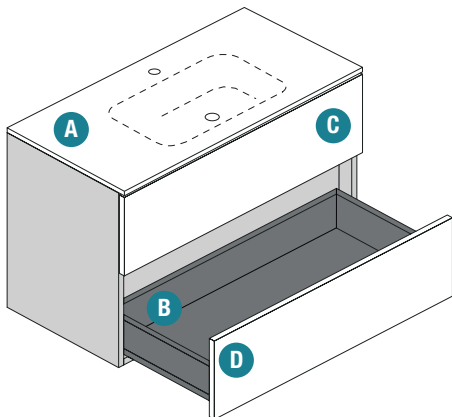

**Sistema Premi-Apri**  
**Premi-Apri System**  
**Système Premi-Apri**  
**Premi-Apri System**



**Nobilitato LEGNO**

pannello di particelle di legno spessore 18 mm idrofugo a basso contenuto di formaldeide nobilitato interno ed esterno con carta melaminica in finitura LEGNO riprodotto ad alta fedeltà; bordo in ABS in finitura

high pressure layered laminate, a perfect and strong imitation of the natural wooden surface

stratifiés décoratifs haute pression. Plaques à base de résines thermoscurissables appelées stratifiés

Hochdruckmehrschichtlaminat mit einer dreidimensionalen Erscheinung

**laccato OPACO / LUCIDO  
MATT / GLOSSY lacquered**

pannello di particelle di legno, idrofugo, a basso contenuto di formaldeide, verniciato con resine poliuretatiche pigmentate opache o lucide

wood particles panel 18 mm with low formaldehyde content, painted with polyurethane resins

**laqué MAT / BRILLANT  
MATT / HOCHGLANZ lackiert**

panneaux de particules de bois 18 mm à faible teneur en formaldéhyde, peint avec des résines de polyuréthane

Holzpartikelplatte 18 mm mit niedrigem Formaldehydgehalt, mit Polyurethanharzen lackiert

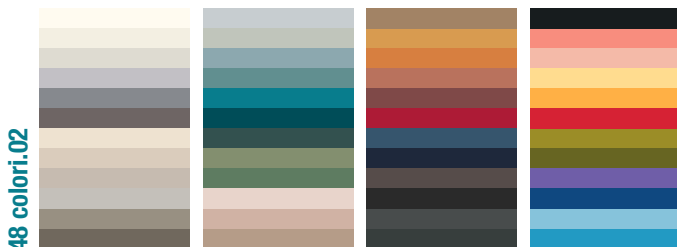

i colori qui riportati sono da considerarsi indicativi  
the colours can diverge from the reality  
la fidélité des couleurs peut être différent de la réalité  
bitte berücksichtigen Sie unsere Farbfächer zur Farbauswahl

**Maniglia PONTE - L 20 cm****FINITURE:**

. laccato OPACO 48 colori.02  
. extra pag. 592



CROMO OPACO



TITANIO



ORO OPACO SATINATO

**PONTE Handle - L 20 cm****FINISHES:**

. MATT lacquered 48 colori.02  
. extra pag. 592

**Poignée PONTE - L 20 cm****FINITIONS:**

. laqué MAT 48 colori.02  
. extra pag. 592

**PONTE Griff - L 20 cm****OBERFLÄCHEN:**

. MATT lackiert 48 colori.02  
. extra pag. 592

**Maniglia FILO - L 20 cm****FINITURE:**

. laccato OPACO 48 colori.02

**FILO Handle - L 20 cm****FINISHES:**

. MATT lacquered 48 colori.02

**Poignée FILO - L 20 cm****FINITIONS:**

. laqué MAT 48 colori.02

**FILO Griff - L 20 cm****OBERFLÄCHEN:**

. MATT lackiert 48 colori.02

**abbinamento consigliato mobile/maniglia**  
**combinations furniture/handle**

mobile Nobilitato LEGNO

	12W ABETE BIANCO
	14W ABETE BROWN
	26W ABETE ROCCIA
	27W ABETE FONDENTE
	31W FRONDA PURO
	32W FRONDA LIEVE
	33W FRONDA NUDO
	34W FRONDA ARCANO



maniglia laccato OPACO

	01 NUDE
	0H CURCUMA
	05 WILD
	0U MOCHA
	01 NUDE
	0G EARTH
	03 NATURE
	59 NERO

**coordinations meuble/poignée**  
**Griffeabstimmung**

UNICAMENTE

AROCK®

ALCENTIMETRO

PROGETTO®

## piani / tops / plans / \Platten

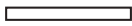

piano e piano d'arredo  
top for interior  
plan pour l'ameublement  
Platte fuer Einrichtung



piano e piano d'arredo accoppiato  
coated  
accouplé  
verdoppelt

## lavabo / basin / vasque / Becken

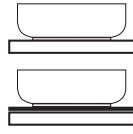

soprapiano da appoggio  
countertop basin  
lavabo à poser  
Aufsetzbecken

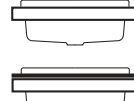

soprapiano da incasso  
recessed basin  
lavabo encastré surélevé  
Halbeinbaubecken

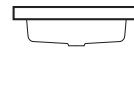

sottopiano da incasso  
undermounted basin  
lavabo en profondeur  
Unteneinbaubecken

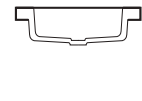

lavabo integrato  
integrated basin  
vasque intégrée  
integriertes Becken

	SP cm	P 45 cm	P 51,5 cm	
<b>AROCK®</b>	1,2 / 6			
<b>Laccato OPACO / LUCIDO</b>	1,8			
<b>Nobilitato LEGNO / ALTATTO</b>	1,8			
<b>Nobilitato LEGNO / ALTATTO + GRES</b> <b>Laccato OPACO / LUCIDO + GRES</b>	2,4			
<b>HPL</b>	1			
<b>GRES</b>	0,6 / 1,2			
	1,2			
<b>CRISTALLO extrachiaro verniciato</b> <b>extra-clear lacquered GLASS</b> <b>VERRE lacquée extraclair</b> <b>Hochglanz lackierte GLAS</b>	1,2			
<b>PIETRA NATURALE</b> <b>NATURAL STONE</b> <b>PIERRE NATURELLE</b> <b>NATURSTEIN</b>	2			
<b>SILESTONE</b>	1,2			



Modularità  
Modularity

Modularité  
Modularität

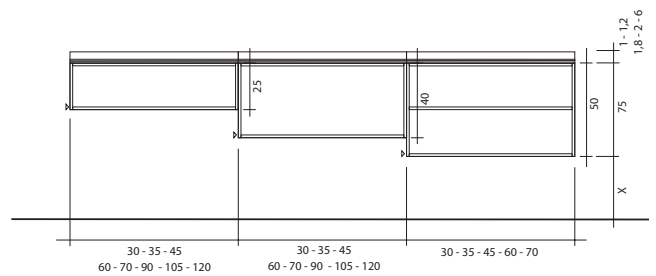
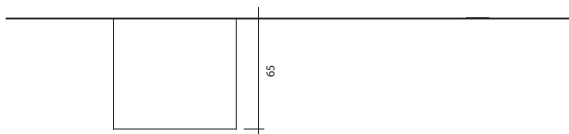
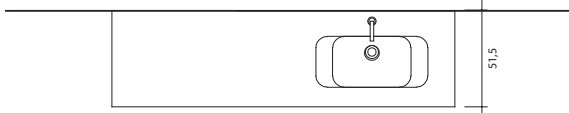
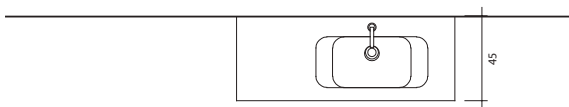
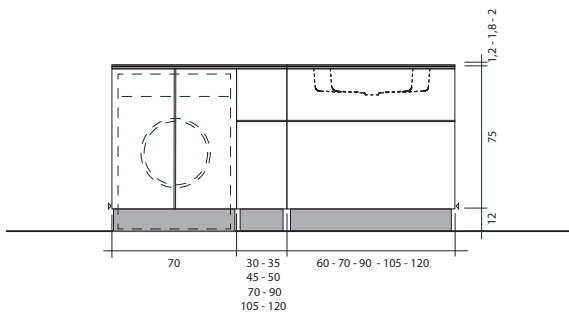
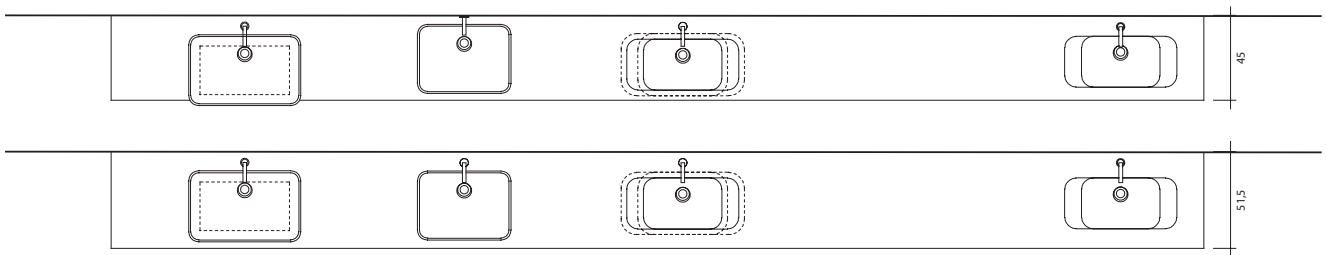
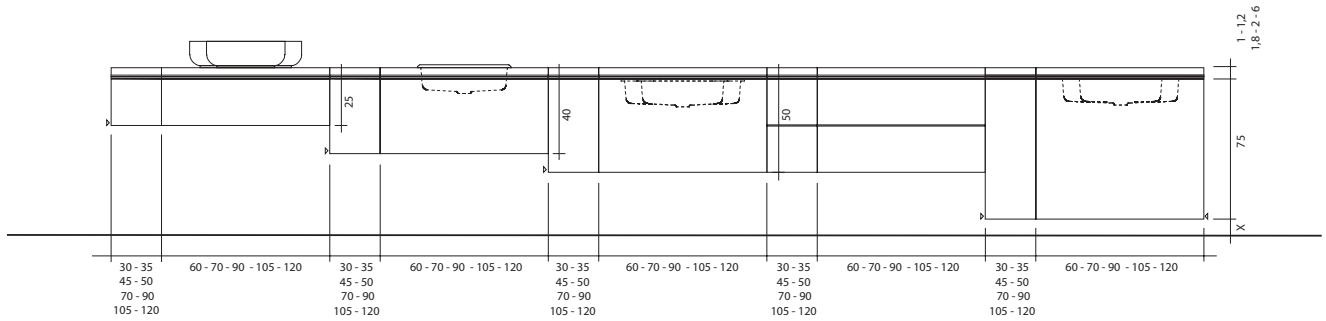

**basi portavaso**  
**vanity units**  
**meubles sous-vasque**  
**Waschtischunterschänke**

L 60-70-90-105-120 cm

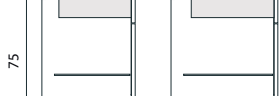
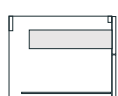
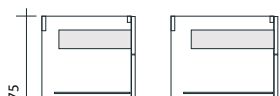
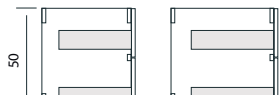
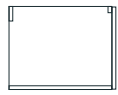
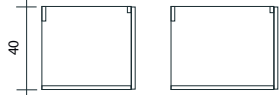
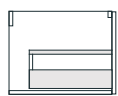
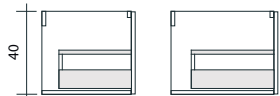
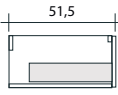
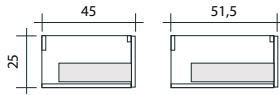

**basi laterali**  
**side units**  
**meubles bas latéraux**  
**Unterschänke**

L 30-35-45-60-70-90-105-120 cm

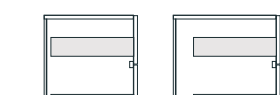
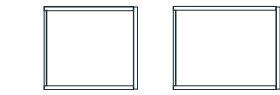
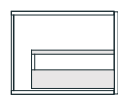
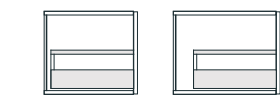
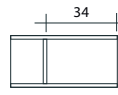
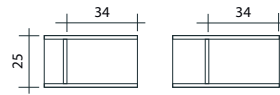
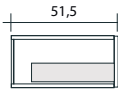
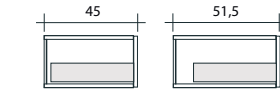

frontale unico estraibile con cassetto, chiusura ammortizzata  
 single pull-out, soft-closing  
 façade amovible avec tiroir  
 1 Schublade

vano a giorno  
 shelving unit  
 éléments ouverts  
 offenen Elementen

frontale unico estraibile con cassetto, chiusura ammortizzata  
 single pull-out, soft-closing  
 façade amovible avec tiroir  
 1 Schublade

1 anta o 2 ante chiusura ammortizzata  
 single door or double door, soft-closing  
 1 porte ou 2 portes  
 1 Tür oder 2 Türen

vano a giorno  
 shelving unit  
 éléments ouverts  
 offenen Elementen

frontale unico estraibile con cassetto chiusura ammortizzata + 1 ripiano  
 single pull-out, soft-closing + 1 shelf  
 façade amovible avec tiroir + 1 étagère  
 1 Schublade + 1 Regal

doppio frontale estraibile con cassetto, chiusura ammortizzata  
 double soft-closing pull-out  
 2 tiroirs amortis  
 2 Schubladen

1 anta o 2 ante chiusura ammortizzata + 1 ripiano  
 single door or double door, soft-closing + 1 shelf  
 1 porte ou 2 portes + 1 étagère  
 1 Tür oder 2 Türen + 1 Regal

vano a giorno  
 shelving unit  
 éléments ouverts  
 offenen Elementen

doppio frontale estraibile con cassetto, chiusura ammortizzata + 1 ripiano  
 double soft-closing pull-out + 1 shelf  
 2 tiroirs amortis + 1 étagère  
 2 Schubladen + 1 Regal

1 anta o 2 ante chiusura ammortizzata + 1 ripiano  
 single door or double door, soft-closing + 1 shelf  
 1 porte ou 2 portes + 1 étagère  
 1 Tür oder 2 Türen + 1 Regal

1 anta o 2 ante chiusura ammortizzata + 1/2 ripiano  
 single door or double door, soft-closing + 1/2 shelf  
 1 porte ou 2 portes + 1/2 étagère  
 1 Tür oder 2 Türen + 1/2 Regal







## Basi a giorno Side shelving units

## Meubles bas ouverts Unterschränke Regalelemente

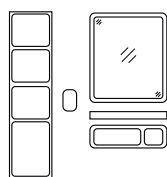

UNICAMENTE  
AROCK®

34

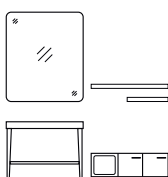

ALCENTIMETRO  
PROGETTO

98

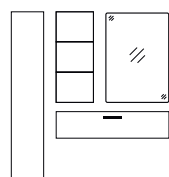

Elementi  
CONTENITORI

180

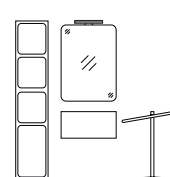

Elementi  
COMPLEMENTARI

226



RICAMBI

592

### H 25



### P 45

Base a giorno  
Side shelving unit  
Meuble bas ouvert  
Unterschrank Regalelement

L		F1	F2	F3
30	N5Q03024			
35	N5Q03524			
45	N5Q04524			
50	N5Q05024			
60	N5Q06024			
70	N5Q07024			
90	N5Q09024			
105	N5Q10524			
120	N5Q12024			

### P 51,5

L		F1	F2	F3
30	N5Q03016			
35	N5Q03516			
45	N5Q04516			
50	N5Q05016			
60	N5Q06016			
70	N5Q07016			
90	N5Q09016			
105	N5Q10516			
120	N5Q12016			

### H 40



### P 45

Base a giorno  
Side shelving unit  
Meuble bas ouvert  
Unterschrank Regalelement

L		F1	F2	F3
30	N5Q03025			
35	N5Q03525			
45	N5Q04525			
50	N5Q05025			
60	N5Q06025			
70	N5Q07025			
90	N5Q09025			
105	N5Q10525			
120	N5Q12025			

### P 51,5

L		F1	F2	F3
30	N5Q03034			
35	N5Q03534			
45	N5Q04534			
50	N5Q05034			
60	N5Q06034			
70	N5Q07034			
90	N5Q09034			
105	N5Q10534			
120	N5Q12034			

### H 50

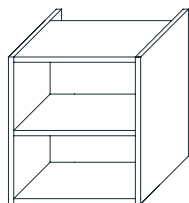

### P 45

Base a giorno • 2 vani  
Side shelving unit • 2 compartments  
Meuble bas ouvert • 2 compartiments  
Unterschrank Regalelement • 2 Fächer

L		F1	F2	F3
30	N5Q03026	220	240	145
35	N5Q03526	235	255	150
45	N5Q04526	260	285	165
50	N5Q05026	295	325	180
60	N5Q06026	305	335	190
70	N5Q07026	330	365	200

### P 51,5

L		F1	F2	F3
30	N5Q03027	235	260	150
35	N5Q03527	250	275	155
45	N5Q04527	280	305	170
50	N5Q05027	310	340	185
60	N5Q06027	320	350	195
70	N5Q07027	350	380	210



Misure in cm  
Measures in cm  
Mesures en cm  
Maße in cm

**F1** Laccato opaco  
Matt lacquered  
Laqué mat  
Matt lackiert

**F2** Laccato lucido  
Glossy lacquered  
Laqué brillant  
Hochglanz lackiert

**F3** Nobilitati  
Veneer wood  
Placage bois  
Beschichtetes Holz

**F4** Arock®  
Arock®  
Arock®  
Arock®

**F5** abitat / vogue  
abitat / vogue  
abitat / vogue  
abitat / vogue

# Basi Units

# Meubles bas Unterschränke

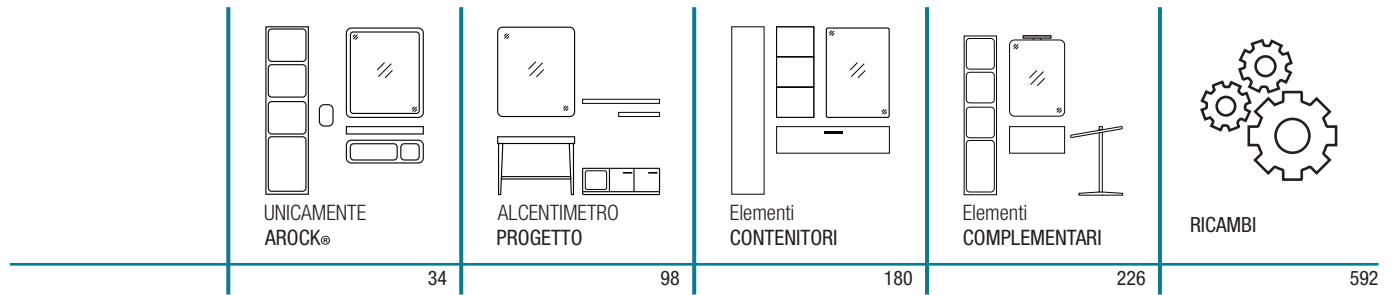

## H 25

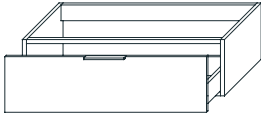

## P 45

Maniglia FILO & chiusura ammortizzata • base portalavabo • 1 cassetto • sifone incl.  
 FILO Handle & soft-closing • vanity unit • 1 pull-out • siphon incl.  
 Poignée FILO & fermeture amortie • meuble sous vasque • 1 tiroir • siphon incl.  
 FILO Griff • Waschtischunterschrank • 1 Soft-Closing Schublade • Siphon inkl.

L		F1	F2	F3
60	N2L06001			
70	N2L07001			
80	N2L08001			
90	N2L09001			
105	N2L10501			
120	N2L12001			

## P 51,5

L		F1	F2	F3
60	N2L06051			
70	N2L07051			
80	N2L08051			
90	N2L09051			
105	N2L10551			
120	N2L12051			

## H 25



## P 45

Maniglia FILO & chiusura ammortizzata • base portalavabo • 1 cassetto • scasso per sifone in posizione variabile  
 FILO Handle & soft-closing • vanity unit • 1 pull-out • cavity for siphon in variable position  
 Poignée FILO & fermeture amortie • meuble sous vasque • 1 tiroir • trou pour le siphon en position variable  
 FILO Griff • Waschtischunterschrank • 1 Soft-Closing Schublade • Siphonousschnitt

L		F1	F2	F3
105	N2L10502			
120	N2L12002			

## P 51,5

L		F1	F2	F3
105	N2L10552			
120	N2L12052			

## H 25

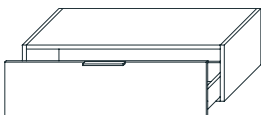

## P 45

Maniglia FILO & chiusura ammortizzata • base laterale • 1 cassetto  
 FILO Handle & soft-closing • side unit • 1 pull-out  
 Poignée FILO & fermeture amortie • meuble bas latéral • 1 tiroir  
 FILO Griff • Seitenschrank • 1 Soft-Closing Schublade

L		F1	F2	F3
30	N2B03001			
35	N2B03501			
45	N2B04501			
50	N2B05001			
60	N2B06001			
70	N2B07001			
90	N2B09001			
105	N2B10501			
120	N2B12001			

## P 51,5

L		F1	F2	F3
30	N2B03051			
35	N2B03551			
45	N2B04551			
50	N2B05051			
60	N2B06051			
70	N2B07051			
90	N2B09051			
105	N2B10551			
120	N2B12051			

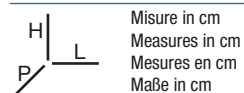

**F1** Laccato opaco  
 Matt lacquered  
 Laqué mat  
 Matt lackiert

**F2** Laccato lucido  
 Glossy lacquered  
 Laqué brillant  
 Hochglanz lackiert

**F3** Nobilitati  
 Veneer wood  
 Placage bois  
 Beschichtetes Holz

**F4** Arock®  
 Arock®  
 Arock®  
 Arock®

**F5** abitat / vogue  
 abitat / vogue  
 abitat / vogue  
 abitat / vogue

# Basi Units

# Meubles bas Unterschränke

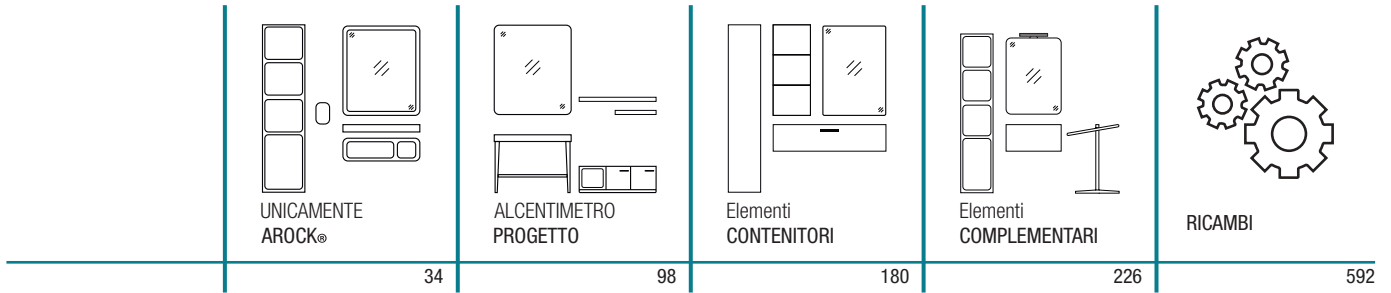

## H 25

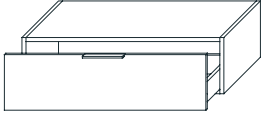

## P 45

Maniglia FILO & chiusura ammortizzata • base laterale • 1 cassetto • scasso per sifone in posizione variabile  
 FILO Handle & soft-closing • side unit • 1 pull-out • cavity for siphon in variable position  
 Poignée FILO & fermeture amortie • meuble bas latéral • 1 tiroir • trou pour le siphon en position variable  
 FILO Griff • Seitenschrank • 1 Soft-Closing Schublade • Siphonousschnitt

L		F1	F2	F3
105	N2B10502			
120	N2B12002			

## P 51,5

L		F1	F2	F3
105	N2B10552			
120	N2B12052			

## H 40

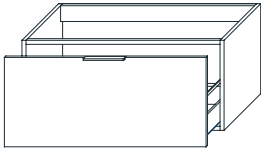

## P 45

Maniglia FILO & chiusura ammortizzata • base portalavabo • 1 cassetto • sifone incl.  
 FILO Handle & soft-closing • vanity unit • 1 pull-out • siphon incl.  
 Poignée FILO & fermeture amortie • meuble sous vasque • 1 tiroir • siphon incl.  
 FILO Griff • Waschtischunterschrank • 1 Soft-Closing Schublade • Siphon inkl.

L		F1	F2	F3
60	N2L06004			
70	N2L07004			
80	N2L08004			
90	N2L09004			
105	N2L10504			
120	N2L12004			

## P 51,5

L		F1	F2	F3
60	N2L06054			
70	N2L07054			
80	N2L08054			
90	N2L09054			
105	N2L10554			
120	N2L12054			

## H 40

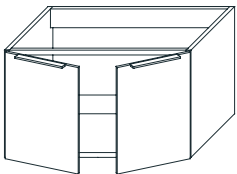

## P 45

Maniglia FILO & chiusura ammortizzata • base portalavabo • 2 ante • sifone incl.  
 FILO Handle & soft-closing • vanity unit • 2 doors • siphon incl.  
 Poignée FILO & fermeture amortie • meuble sous vasque • 2 portes • siphon incl.  
 FILO Griff • Waschtischunterschrank • 2 Türen • Siphon inkl.

L		F1	F2	F3
60	N2L06005			
70	N2L07005			
80	N2L08005			
90	N2L09005			

## P 51,5

L		F1	F2	F3
60	N2L06055			
70	N2L07055			
80	N2L08055			
90	N2L09055			



Misure in cm  
 Measures in cm  
 Mesures en cm  
 Maße in cm

**F1** Laccato opaco  
 Matt lacquered  
 Laqué mat  
 Matt lackiert

**F2** Laccato lucido  
 Glossy lacquered  
 Laqué brillant  
 Hochglanz lackiert

**F3** Nobilitati  
 Veneer wood  
 Placage bois  
 Beschichtetes Holz

**F4** Arock®  
 Arock®  
 Arock®  
 Arock®

**F5** abitat / vogue  
 abitat / vogue  
 abitat / vogue  
 abitat / vogue

# Basi Units

# Meubles bas Unterschränke

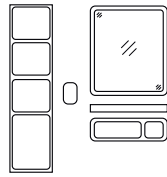

UNICAMENTE  
AROCK®

34

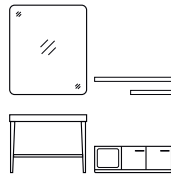

ALCENTIMETRO  
PROGETTO

98

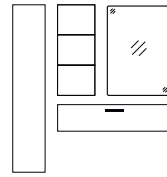

Elementi  
CONTENITORI

180

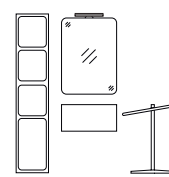

Elementi  
COMPLEMENTARI

226



RICAMBI

592

## H 40

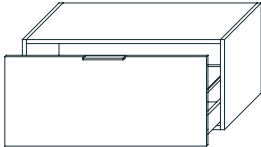

## P 45

Maniglia FILO & chiusura ammortizzata • base laterale • 1 cassetto  
FILO Handle & soft-closing • side unit • 1 pull-out  
Poignée FILO & fermeture amortie • meuble bas latéral • 1 tiroir  
FILO Griff • Seitenschrank • 1 Soft-Closing Schublade

L		F1	F2	F3
30	N2B03007			
35	N2B03507			
45	N2B04507			
50	N2B05007			
60	N2B06007			
70	N2B07007			
90	N2B09007			
105	N2B10507			
120	N2B12007			

## P 51,5

L		F1	F2	F3
30	N2B03057	275	305	235
35	N2B03557	290	320	250
45	N2B04557	305	340	265
50	N2B05057	325	360	280
60	N2B06057	335	370	290
70	N2B07057	420	465	365
90	N2B09057	440	485	380
105	N2B10557	450	495	390
120	N2B12057	470	520	405

## H 40

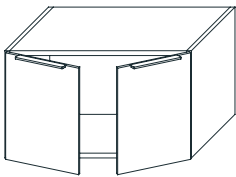

## P 45

Maniglia FILO & chiusura ammortizzata • base laterale • 2 ante  
FILO Handle & soft-closing • side unit • 2 doors  
Poignée FILO & fermeture amortie • meuble bas latéral • 2 portes  
FILO Griff • Seitenschrank • 2 Türen

L		F1	F2	F3
50	N2B05010			
60	N2B06010			
70	N2B07010			
90	N2B09010			

## P 51,5

L		F1	F2	F3
50	N2B05060			
60	N2B06060			
70	N2B07060			
90	N2B09060			

## H 40

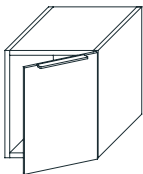

## P 45

Maniglia FILO & chiusura ammortizzata • base laterale dx • 1 anta  
FILO Handle & soft-closing • side unit • 1 door  
Poignée FILO & fermeture amortie • meuble bas latéral • 1 porte  
FILO Griff • Seitenschrank • 1 Tür

L		F1	F2	F3
30	N2B03008			
35	N2B03508			
45	N2B04508			

## P 51,5

L		F1	F2	F3
30	N2B03058			
35	N2B03558			
45	N2B04558			



Misure in cm  
Measures in cm  
Mesures en cm  
Maße in cm

**F1** Laccato opaco  
Matt lacquered  
Laqué mat  
Matt lackiert

**F2** Laccato lucido  
Glossy lacquered  
Laqué brillant  
Hochglanz lackiert

**F3** Nobilitati  
Veneer wood  
Placage bois  
Beschichtetes Holz

**F4** Arock®  
Arock®  
Arock®  
Arock®

**F5** abitat / vogue  
abitat / vogue  
abitat / vogue  
abitat / vogue

## Basi Units

## Meubles bas Unterschränke

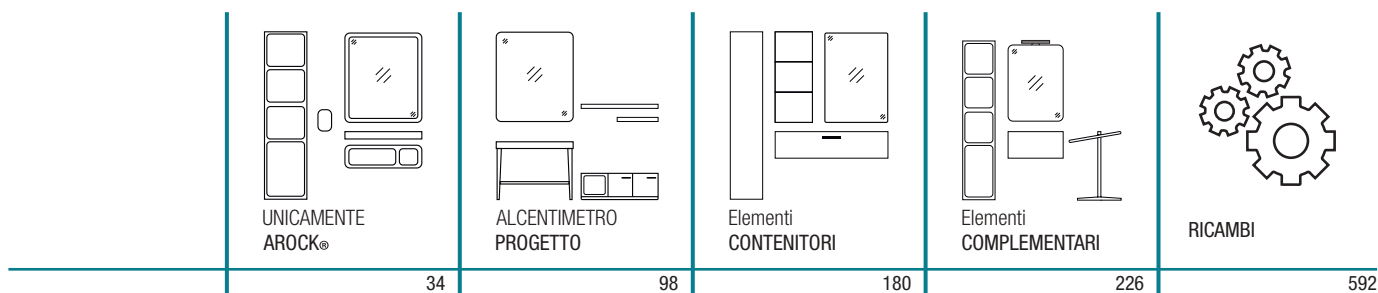

### H 40

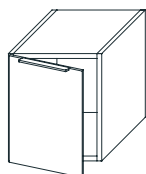

### P 45

Maniglia FILO & chiusura ammortizzata • base laterale sx • 1 anta  
FILO Handle & soft-closing • side unit • 1 door  
Poignée FILO & fermeture amortie • meuble bas latéral • 1 porte  
FILO Griff • Seitenschrank • 1 Tür

L		F1	F2	F3
30	N2B03009			
35	N2B03509			
45	N2B04509			

### P 51,5

L		F1	F2	F3
30	N2B03059			
35	N2B03559			
45	N2B04559			

### H 50

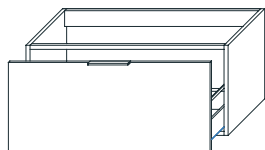

### P 45

Maniglia FILO & chiusura ammortizzata • base portavaso • 1 cassetto  
FILO Handle & soft-closing • vanity unit • 1 pull out  
Poignée FILO & fermeture amortie • meuble sous vasque • 1 tiroir  
FILO Griff • Waschtischunterschrank • 1 Soft-Closing Schublade

L		F1	F2	F3
60	N2L06019			
70	N2L07019			
80	N2L08019			
90	N2L09019			

### P 51,5

L		F1	F2	F3
60	N2L06069			
70	N2L07069			
80	N2L08069			
90	N2L09069			

### H 50

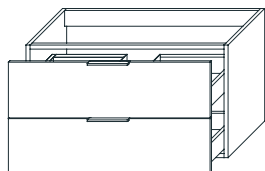

### P 45

Maniglia FILO & chiusura ammortizzata • base portavaso • 2 cassetti • sifone incl.  
FILO Handle & soft-closing • vanity unit • 2 pull-out • siphon incl.  
Poignée FILO & fermeture amortie • meuble sous vasque • 2 tiroirs • siphon incl.  
FILO Griff • Waschtischunterschrank • 2 Soft-Closing Schubladen • Siphon inkl.

L		F1	F2	F3
60	N2L06012			
70	N2L07012			
80	N2L08012			
90	N2L09012			
105	N2L10512			
120	N2L12012			

### P 51,5

L		F1	F2	F3
60	N2L06062			
70	N2L07062			
80	N2L08062			
90	N2L09062			
105	N2L10562			
120	N2L12062			



Misure in cm  
Measures in cm  
Mesures en cm  
Maße in cm

**F1** Laccato opaco  
Matt lacquered  
Laqué mat  
Matt lackiert

**F2** Laccato lucido  
Glossy lacquered  
Laqué brillant  
Hochglanz lackiert





**F3** Nobilitati  
Veneer wood  
Placage bois  
Beschichtetes Holz

**F4** Arock®  
Arock®  
Arock®  
Arock®

**F5** abitat / vogue  
abitat / vogue  
abitat / vogue  
abitat / vogue

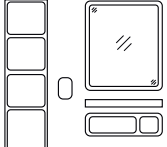
## Basi Units

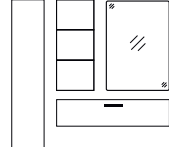
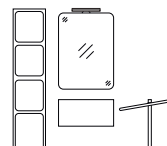
## Meubles bas Unterschränke

				
UNICAMENTE AROCK®	ALCENTIMETRO PROGETTO	Elementi CONTENITORI	Elementi COMPLEMENTARI	RICAMBI
34	98	180	226	592

### H 50

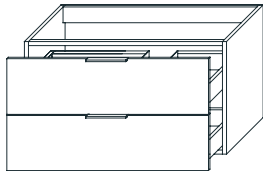

### P 45

Maniglia FILO & chiusura ammortizzata • base portalavabo • 2 cassetti • scasso per sifone dx  
 FILO Handle & soft-closing • vanity unit • 2 pull-out • right cavity for siphon  
 Poignée FILO & fermeture amortie • meuble sous vasque • 2 tiroirs • trou droite pour le siphon  
 FILO Griff • Waschtischunterschrank • 2 Soft-Closing Schubladen • Siphonousschnitt-rechts

L	F1	F2	F3
105 N2L10516			

### P 51,5

L	F1	F2	F3
105 N2L10566			

### H 50

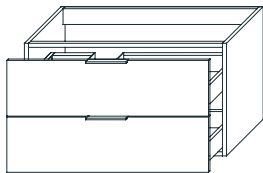

### P 45

Maniglia FILO & chiusura ammortizzata • base portalavabo • 2 cassetti • scasso per sifone sx  
 FILO Handle & soft-closing • vanity unit • 2 pull-out • left cavity for siphon  
 Poignée FILO & fermeture amortie • meuble sous vasque • 2 tiroirs • trou gauche pour le siphon  
 FILO Griff • Waschtischunterschrank • 2 Soft-Closing Schubladen • Siphonousschnitt-links

L	F1	F2	F3
105 N2L10517			

### P 51,5

L	F1	F2	F3
105 N2L10567			

### H 50

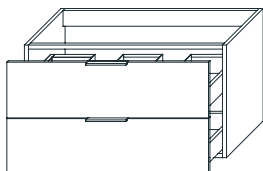

### P 45

Maniglia FILO & chiusura ammortizzata • base portalavabo • 2 cassetti • scasso per sifone doppio  
 FILO Handle & soft-closing • vanity unit • 2 pull-out • double cavity for siphon  
 Poignée FILO & fermeture amortie • meuble sous vasque • 2 tiroirs • trou pour le siphon double  
 FILO Griff • Waschtischunterschrank • 2 Soft-Closing Schubladen • Siphonousschnitt-doppelt

L	F1	F2	F3
120 N2L12011			

### P 51,5

L	F1	F2	F3
120 N2L12061			

 Misure in cm  
 Measures in cm  
 Mesures en cm  
 Maße in cm

**F1** Laccato opaco  
 Matt lacquered  
 Laqué mat  
 Matt lackiert

**F2** Laccato lucido  
 Glossy lacquered  
 Laqué brillant  
 Hochglanz lackiert

**F3** Nobilitati  
 Veneer wood  
 Placage bois  
 Beschichtetes Holz

**F4** Arock®  
 Arock®  
 Arock®  
 Arock®

**F5** abitat / vogue  
 abitat / vogue  
 abitat / vogue  
 abitat / vogue

# Basi Units

# Meubles bas Unterschränke

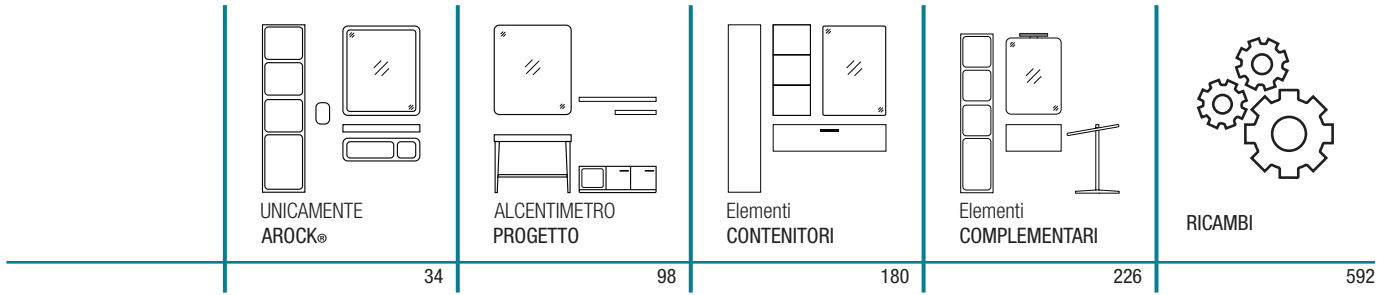

## H 50

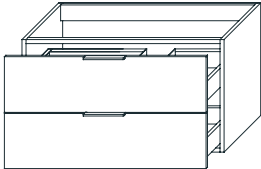

## P 45

Maniglia FILO & chiusura ammortizzata • base portalavabo • 2 cassetti • scasso per sifone dx  
 FILO Handle & soft-closing • vanity unit • 2 pull-out • right cavity for siphon  
 Poignée FILO & fermeture amortie • meuble sous vasque • 2 tiroirs • trou droite pour le siphon  
 FILO Griff • Waschtischunterschrank • 2 Soft-Closing Schubladen • Siphonousschnitt-rechts

L	F1	F2	F3
120 N2L12014			

## P 51,5

L	F1	F2	F3
120 N2L12064			

## H 50

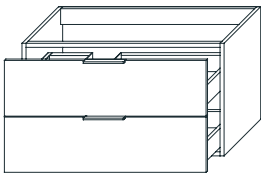

## P 45

Maniglia FILO & chiusura ammortizzata • base portalavabo • 2 cassetti • scasso per sifone sx  
 FILO Handle & soft-closing • vanity unit • 2 pull-out • left cavity for siphon  
 Poignée FILO & fermeture amortie • meuble sous vasque • 2 tiroirs • trou gauche pour le siphon  
 FILO Griff • Waschtischunterschrank • 2 Soft-Closing Schubladen • Siphonousschnitt-links

L	F1	F2	F3
120 N2L12015			

## P 51,5

L	F1	F2	F3
120 N2L12065			

## H 50

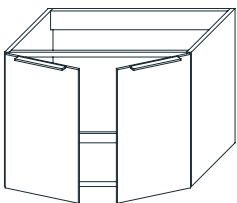

## P 45

Maniglia FILO & chiusura ammortizzata • base portalavabo • 2 ante • sifone incl.  
 FILO Handle & soft-closing • vanity unit • 2 doors • siphon incl.  
 Poignée FILO & fermeture amortie • meuble sous vasque • 2 portes • siphon incl.  
 FILO Griff • Waschtischunterschrank • 2 Türen • Siphon inkl.

L	F1	F2	F3
60 N2L06013			
70 N2L07013			
80 N2L08013			
90 N2L09013			

## P 51,5

L	F1	F2	F3
60 N2L06063			
70 N2L07063			
80 N2L08063			
90 N2L09063			



Misure in cm  
 Measures in cm  
 Mesures en cm  
 Maße in cm

**F1** Laccato opaco  
 Matt lacquered  
 Laqué mat  
 Matt lackiert

**F2** Laccato lucido  
 Glossy lacquered  
 Laqué brillant  
 Hochglanz lackiert

**F3** Nobilitati  
 Veneer wood  
 Placage bois  
 Beschichtetes Holz





**F4** Arock®  
 Arock®  
 Arock®  
 Arock®

**F5** abitat / vogue  
 abitat / vogue  
 abitat / vogue  
 abitat / vogue

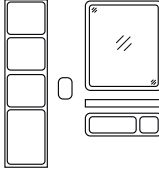

# Basi Units

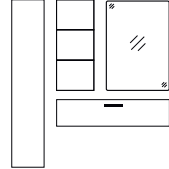
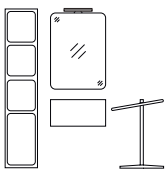
# Meubles bas Unterschränke

				
UNICAMENTE AROCK®	ALCENTIMETRO PROGETTO	Elementi CONTENITORI	Elementi COMPLEMENTARI	RICAMBI
34	98	180	226	592

## H50

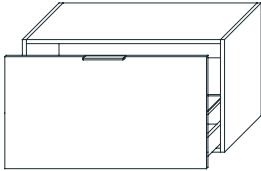

## P 45

Maniglia FILO & chiusura ammortizzata • base laterale • 1 cassetto + 1 ripiano  
FILO Handle & soft-closing • side unit • 1 pull-out + 1 shelf  
Poignée FILO & fermeture amortie • meuble bas latéral • 1 tiroir + 1 étagère  
FILO Griff • Seitenschrank • 1 Soft-Closing Schublade + 1 Regal

L		F1	F2	F3
30	N2B03019			
35	N2B03519			
45	N2B04519			
50	N2B05019			
60	N2B06019			
70	N2B07019			
90	N2B09019			
105	N2B10519			
120	N2B12019			

## P 51,5

L		F1	F2	F3
30	N2B03069			
35	N2B03569			
45	N2B04569			
50	N2B05069			
60	N2B06069			
70	N2B07069			
90	N2B09069			
105	N2B10569			
120	N2B12069			

## H 50

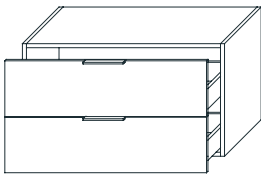

## P 45

Maniglia FILO & chiusura ammortizzata • base laterale • 2 cassetti  
FILO Handle & soft-closing • side unit • 2 pull-out  
Poignée FILO & fermeture amortie • meuble bas latéral • 2 tiroirs  
FILO Griff • Seitenschrank • 2 Soft-Closing Schubladen

L		F1	F2	F3
30	N2B03012			
35	N2B03512			
45	N2B04512			
50	N2B05012			
60	N2B06012			
70	N2B07012			
90	N2B09012			
105	N2B10512			
120	N2B12012			

## P 51,5

L		F1	F2	F3
30	N2B03062			
35	N2B03562			
45	N2B04562			
50	N2B05062			
60	N2B06062			
70	N2B07062			
90	N2B09062			
105	N2B10562			
120	N2B12062			

## H 50

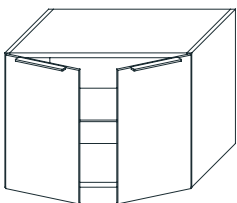

## P 45

Maniglia FILO & chiusura ammortizzata • base laterale • 2 ante + 1 ripiano  
FILO Handle & soft-closing • side unit • 2 doors + 1 shelf  
Poignée FILO & fermeture amortie • meuble bas latéral • 2 portes + 1 étagère  
FILO Griff • Seitenschrank • 2 Türen + 1 Regal

L		F1	F2	F3
50	N2B05014			
60	N2B06014			
70	N2B07014			
90	N2B09014			

## P 51,5

L		F1	F2	F3
50	N2B05064			
60	N2B06064			
70	N2B07064			
90	N2B09064			

  
 H | L  
 P |  
 Misure in cm  
 Mesures in cm  
 Mesures en cm  
 Maße in cm

**F1** Laccato opaco  
Matt lacquered  
Laqué mat  
Matt lackiert

**F2** Laccato lucido  
Glossy lacquered  
Laqué brillant  
Hochglanz lackiert

**F3** Nobilitati  
Veneer wood  
Placage bois  
Beschichtetes Holz

**F4** Arock®  
Arock®  
Arock®  
Arock®

**F5** abitat / vogue  
abitat / vogue  
abitat / vogue  
abitat / vogue

# Basi Units

# Meubles bas Unterschränke

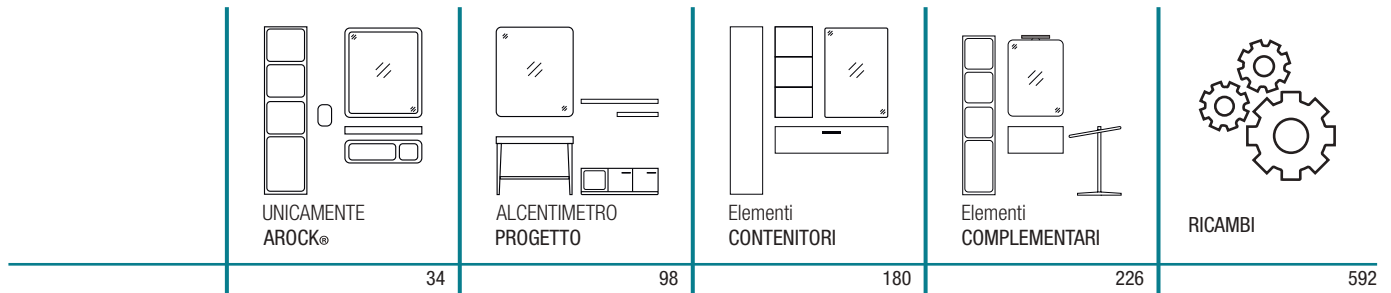
UNICAMENTE  
AROCK®ALCENTIMETRO  
PROGETTOElementi  
CONTENITORIElementi  
COMPLEMENTARI

RICAMBI

34

98

180

226

592

## H 50

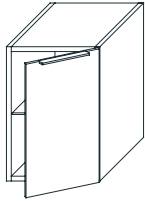

### P 45

Maniglia FILO & chiusura ammortizzata • base laterale dx • 1 anta + 1 ripiano  
 FILO Handle & soft-closing • side unit • 1 door + 1 shelf  
 Poignée FILO & fermeture amortie • meuble bas latéral • 1 porte + 1 étagère  
 FILO Griff • Seitenschrank • 1 Tür + 1 Regal

L		F1	F2	F3
30	N2B03016			
35	N2B03516			
45	N2B04516			

### P 51,5

L		F1	F2	F3
30	N2B03066			
35	N2B03566			
45	N2B04566			

## H 50

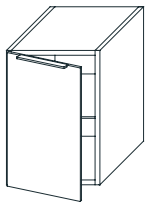

### P 45

Maniglia FILO & chiusura ammortizzata • base laterale sx • 1 anta + 1 ripiano  
 FILO Handle & soft-closing • side unit • 1 door + 1 shelf  
 Poignée FILO & fermeture amortie • meuble bas latéral • 1 porte + 1 étagère  
 FILO Griff • Seitenschrank • 1 Tür + 1 Regal

L		F1	F2	F3
30	N2B03017			
35	N2B03517			
45	N2B04517			

### P 51,5

L		F1	F2	F3
30	N2B03067			
35	N2B03567			
45	N2B04567			

## H 75

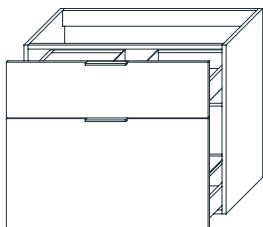

### P 45

Maniglia FILO & chiusura ammortizzata • base portalavabo • 2 cassetti • sifone incl.  
 FILO Handle & soft-closing • vanity unit • 2 pull-out • siphon incl.  
 Poignée FILO & fermeture amortie • meuble sous vasque • 2 tiroirs • siphon incl.  
 FILO Griff • Waschtischunterschrank • 2 Soft-Closing Schubladen • Siphon inkl.

L		F1	F2	F3
60	N2L06022			
70	N2L07022			
80	N2L08022			
90	N2L09022			
105	N2L10522			
120	N2L12022			

### P 51,5

L		F1	F2	F3
60	N2L06072			
70	N2L07072			
80	N2L08072			
90	N2L09072			
105	N2L10572			
120	N2L12072			



Misure in cm  
 Measures in cm  
 Mesures en cm  
 Maße in cm

**F1** Laccato opaco  
 Matt lacquered  
 Laqué mat  
 Matt lackiert

**F2** Laccato lucido  
 Glossy lacquered  
 Laqué brillant  
 Hochglanz lackiert





**F3** Nobilitati  
 Veneer wood  
 Placage bois  
 Beschichtetes Holz

**F4** Arock®  
 Arock®  
 Arock®  
 Arock®

**F5** abitat / vogue  
 abitat / vogue  
 abitat / vogue  
 abitat / vogue

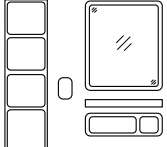
# Basi Units

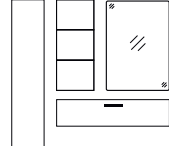
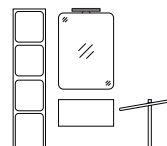
# Meubles bas Unterschränke

				
UNICAMENTE AROCK®	ALCENTIMETRO PROGETTO	Elementi CONTENITORI	Elementi COMPLEMENTARI	RICAMBI
34	98	180	226	592

## H 75

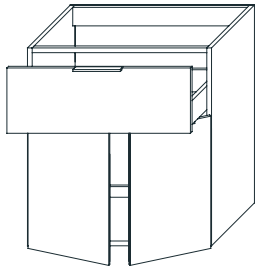

## P 45

Maniglia FILO & chiusura ammortizzata • base portalavabo • 1 cassetto + 2 ante • sifone incl.  
 FILO Handle & soft-closing • vanity unit • 1 pull-out + 2 doors • siphon incl.  
 Poignée FILO & fermeture amortie • meuble sous vasque • 1 tiroir + 2 portes • siphon incl.  
 FILO Griff • Waschtischunterschrank • 1 Soft-Closing Schublade + 2 Türen • Siphon inkl.

L		F1	F2	F3
60	N2L06023			
70	N2L07023			
80	N2L08023			
90	N2L09023			

## P 51,5

L		F1	F2	F3
60	N2L06073			
70	N2L07073			
80	N2L08073			
90	N2L09073			

## H 75

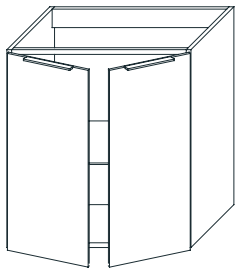

## P 45

Maniglia FILO & chiusura ammortizzata • base portalavabo • 2 ante + 1 ripiano • sifone incl.  
 FILO Handle & soft-closing • vanity unit • 2 doors + 1 shelf • siphon incl.  
 Poignée FILO & fermeture amortie • meuble sous vasque • 2 portes + 1 étagère • siphon incl.  
 FILO Griff • Waschtischunterschrank • 2 Türen + 1 Regal • Siphon inkl.

L		F1	F2	F3
60	N2L06024			
70	N2L07024			
80	N2L08024			
90	N2L09024			

## P 51,5

L		F1	F2	F3
60	N2L06074			
70	N2L07074			
80	N2L08074			
90	N2L09074			

## H 75

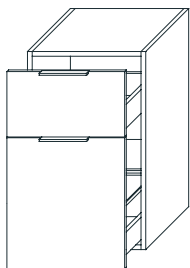

## P 45

Maniglia FILO & chiusura ammortizzata • base laterale • 2 ante + 1 ripiano  
 FILO Handle & soft-closing • side unit • 2 doors + 1 shelf  
 Poignée FILO & fermeture amortie • meuble bas latéral • 2 tiroirs + 1 étagère  
 FILO Griff • Seitenschrank • 2 Türen + 1 Regal

L		F1	F2	F3
30	N2B03025			
35	N2B03525			
45	N2B04525			
50	N2B05025			
60	N2B06025			

## P 51,5

L		F1	F2	F3
30	N2B03075			
35	N2B03575			
45	N2B04575			
50	N2B05075			
60	N2B06075			

 Misure in cm  
 Measures in cm  
 Mesures en cm  
 Maße in cm

**F1** Laccato opaco  
Matt lacquered  
Laqué mat  
Matt lackiert

**F2** Laccato lucido  
Glossy lacquered  
Laqué brillant  
Hochglanz lackiert

**F3** Nobilitati  
Veneer wood  
Placage bois  
Beschichtetes Holz

**F4** Arock®  
Arock®  
Arock®  
Arock®

**F5** abitat / vogue  
abitat / vogue  
abitat / vogue  
abitat / vogue





# Basi Units

# Meubles bas Unterschränke

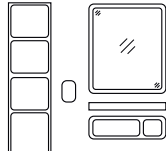

UNICAMENTE  
AROCK®

34



ALCENTIMETRO  
PROGETTO

98

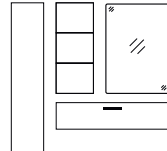

Elementi  
CONTENITORI

180

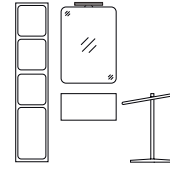

Elementi  
COMPLEMENTARI

226



RICAMBI

592

## H 75

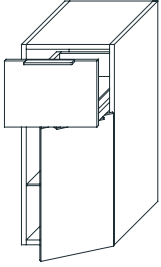

### P 45

Maniglia FILO & chiusura ammortizzata • base laterale dx • 1 cassetto + 1 anta + 1 ripiano  
 FILO Handle & soft-closing • side unit • 1 pull-out + 1 door + 1 shelf  
 Poignée FILO & fermeture amortie • meuble bas latéral • 1 tiroir + 1 porte + 1 étagère  
 FILO Griff • Seitenschrank • 1 Soft-Closing Schublade + 1 Tür + 1 Regal

L		F1	F2	F3
30	N2B03026			
35	N2B03526			
45	N2B04526			

### P 51,5

Maniglia FILO & chiusura ammortizzata • base laterale dx • 1 cassetto + 1 anta + 1 ripiano  
 FILO Handle & soft-closing • side unit • 1 pull-out + 1 door + 1 shelf  
 Poignée FILO & fermeture amortie • meuble bas latéral • 1 tiroir + 1 porte + 1 étagère  
 FILO Griff • Seitenschrank • 1 Soft-Closing Schublade + 1 Tür + 1 Regal

L		F1	F2	F3
30	N2B03076			
35	N2B03576			
45	N2B04576			

## H 75

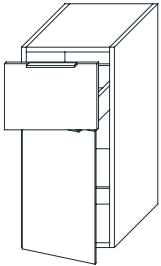

### P 45

Maniglia FILO & chiusura ammortizzata • base laterale sx • 1 cassetto + 1 anta + 1 ripiano  
 FILO Handle & soft-closing • side unit • 1 pull-out + 1 door + 1 shelf  
 Poignée FILO & fermeture amortie • meuble bas latéral • 1 tiroir + 1 porte + 1 étagère  
 FILO Griff • Seitenschrank • 1 Soft-Closing Schublade + 1 Tür + 1 Regal

L		F1	F2	F3
30	N2B03027			
35	N2B03527			
45	N2B04527			

### P 51,5

Maniglia FILO & chiusura ammortizzata • base laterale sx • 1 cassetto + 1 anta + 1 ripiano  
 FILO Handle & soft-closing • side unit • 1 pull-out + 1 door + 1 shelf  
 Poignée FILO & fermeture amortie • meuble bas latéral • 1 tiroir + 1 porte + 1 étagère  
 FILO Griff • Seitenschrank • 1 Soft-Closing Schublade + 1 Tür + 1 Regal

L		F1	F2	F3
30	N2B03077			
35	N2B03577			
45	N2B04577			

## H 75

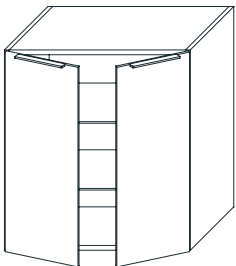

### P 45

Maniglia FILO & chiusura ammortizzata • base laterale • 2 ante + 2 ripiani  
 FILO Handle & soft-closing • side unit • 2 doors + 2 shelves  
 Poignée FILO & fermeture amortie • meuble bas latéral • 2 portes + 2 étagères  
 FILO Griff • Seitenschrank • 2 Türen + 2 Regale

L		F1	F2	F3
50	N2B05029			
60	N2B06029			
70	N2B07029			
90	N2B09029			

### P 51,5

Maniglia FILO & chiusura ammortizzata • base laterale • 2 ante + 2 ripiani  
 FILO Handle & soft-closing • side unit • 2 doors + 2 shelves  
 Poignée FILO & fermeture amortie • meuble bas latéral • 2 portes + 2 étagères  
 FILO Griff • Seitenschrank • 2 Türen + 2 Regale

L		F1	F2	F3
50	N2B05079			
60	N2B06079			
70	N2B07079			
90	N2B09079			



Misure in cm  
 Measures in cm  
 Mesures en cm  
 Maße in cm

**F1** Laccato opaco  
 Matt lacquered  
 Laqué mat  
 Matt lackiert

**F2** Laccato lucido  
 Glossy lacquered  
 Laqué brillant  
 Hochglanz lackiert





**F3** Nobilitati  
 Veneer wood  
 Placage bois  
 Beschichtetes Holz

**F4** Arock®  
 Arock®  
 Arock®  
 Arock®

**F5** abitat / vogue  
 abitat / vogue  
 abitat / vogue  
 abitat / vogue

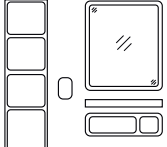
# Basi Units

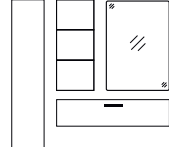
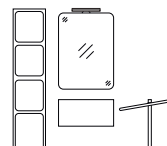
# Meubles bas Unterschränke

				
UNICAMENTE AROCK®	ALCENTIMETRO PROGETTO	Elementi CONTENITORI	Elementi COMPLEMENTARI	RICAMBI
34	98	180	226	592

## H 75

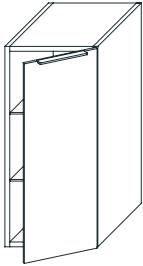

## P 45

Maniglia FILO & chiusura ammortizzata • base laterale dx • 1 anta + 2 ripiani  
 FILO Handle & soft-closing • side unit • 1 door + 2 shelves  
 Poignée FILO & fermeture amortie • meuble bas latéral • 1 porte + 2 étagères  
 FILO Griff • Seitenschrank • 1 Tür + 2 Regale

L		F1	F2	F3
30	N2B03030			
35	N2B03530			
45	N2B04530			

## P 51,5

L		F1	F2	F3
30	N2B03080			
35	N2B03580			
45	N2B04580			

## H 75

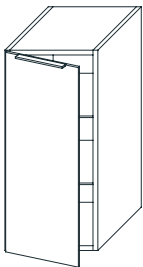

## P 45

Maniglia FILO & chiusura ammortizzata • base laterale sx • 1 anta + 2 ripiani  
 FILO Handle & soft-closing • side unit • 1 door + 2 shelves  
 Poignée FILO & fermeture amortie • meuble sous vasque • 1 porte + 2 étagères  
 FILO Griff • Seitenschrank • 1 Tür + 2 Regale

L		F1	F2	F3
30	N2B03031			
35	N2B03531			
45	N2B04531			

## P 51,5

L		F1	F2	F3
30	N2B03081			
35	N2B03581			
45	N2B04581			

## H 87

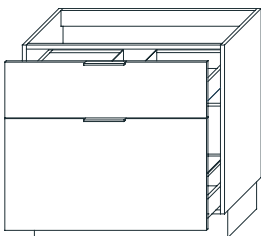

## P 45

Maniglia FILO & chiusura ammortizzata • base portalavabo • 2 cassetti • zoccolo H 12 + sifone incl.  
 FILO Handle & soft-closing • vanity unit • 2 pull-out • toe-kick H 12 + siphon incl.  
 Poignée FILO & fermeture amortie • meuble sous vasque • 2 tiroirs • socle H 12 + siphon incl.  
 FILO Griff • Waschtischunterschrank • 2 Soft-Closing Schubladen • Sockel H 12 + Siphon inkl.

L		F1	F2	F3
60	N2L06034			
70	N2L07034			
80	N2L08034			
90	N2L09034			
105	N2L10534			
120	N2L12034			

## P 51,5

L		F1	F2	F3
60	N2L06084			
70	N2L07084			
80	N2L08084			
90	N2L09084			
105	N2L10584			
120	N2L12084			

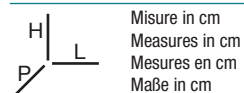

Misure in cm  
 Measures in cm  
 Mesures en cm  
 Maße in cm

**F1** Laccato opaco  
 Matt lacquered  
 Laqué mat  
 Matt lackiert

**F2** Laccato lucido  
 Glossy lacquered  
 Laqué brillant  
 Hochglanz lackiert

**F3** Nobilitati  
 Veneer wood  
 Placage bois  
 Beschichtetes Holz

**F4** Arock®  
 Arock®  
 Arock®  
 Arock®

**F5** abitat / vogue  
 abitat / vogue  
 abitat / vogue  
 abitat / vogue

# Basi Units

# Meubles bas Unterschränke

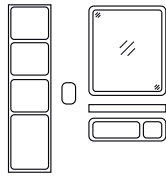

UNICAMENTE  
AROCK®

34

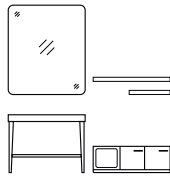

ALCENTIMETRO  
PROGETTO

98

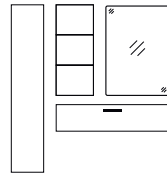

Elementi  
CONTENTORI

180

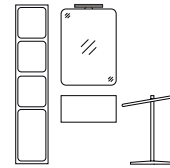

Elementi  
COMPLEMENTARI

226



RICAMBI

592

## H 87

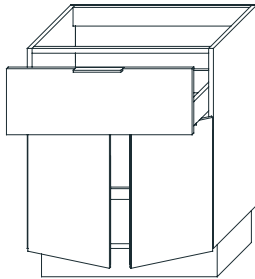

### P 45

Maniglia FILO & chiusura ammortizzata • base portalavabo • 1 cassetto + 2 ante • zoccolo H 12 + sifone incl.  
FILO Handle & soft-closing • vanity unit • 1 pull-out + 2 doors • toe-kick H 12 + siphon incl.  
Poignée FILO & fermeture amortie • meuble sous vasque • 1 tiroir + 2 portes • socle H 12 + siphon incl.  
FILO Griff • Waschtischunterschrank • 1 Soft-Closing Schublade + 2 Türen • Sockel H 12 + Siphon inkl.

L		F1	F2	F3
60	N2L06035			
70	N2L07035			
80	N2L08035			
90	N2L09035			

### P 51,5

L		F1	F2	F3
60	N2L06085			
70	N2L07085			
80	N2L08085			
90	N2L09085			

## H 87

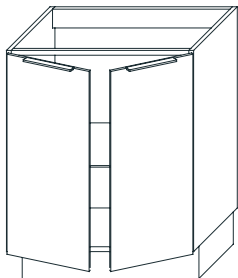

### P 45

Maniglia FILO & chiusura ammortizzata • base portalavabo • 2 ante + 1 ripiano • zoccolo H 12 + sifone incl.  
FILO Handle & soft-closing • vanity unit • 2 doors + 1 shelf • toe-kick H 12 + siphon incl.  
Poignée FILO & fermeture amortie • meuble sous vasque • 2 portes + 1 étagère • socle H 12 + siphon incl.  
FILO Griff • Waschtischunterschrank • 2 Türen + 1 Regal • Sockel H 12 + Siphon inkl.

L		F1	F2	F3
60	N2L06036			
70	N2L07036			
80	N2L08036			
90	N2L09036			

### P 51,5

L		F1	F2	F3
60	N2L06086			
70	N2L07086			
80	N2L08086			
90	N2L09086			

## H 87

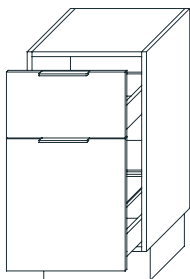

### P 45

Maniglia FILO & chiusura ammortizzata • base laterale • 2 cassetti + 1 ripiano • zoccolo H 12 incl.  
FILO Handle & soft-closing • side unit • 2 pull-out + 1 shelf • toe-kick H 12 incl.  
Poignée FILO & fermeture amortie • meuble bas latéral • 2 tiroirs + 1 étagère • socle H 12 incl.  
FILO Griff • Seitenschrank • 2 Soft-Closing Schubladen + 1 Regal • Sockel H 12 inkl.

L		F1	F2	F3
30	N2B03037			
35	N2B03537			
45	N2B04537			
50	N2B05037			
60	N2B06037			

### P 51,5

L		F1	F2	F3
30	N2B03087			
35	N2B03587			
45	N2B04587			
50	N2B05087			
60	N2B06087			



Misure in cm  
Measures in cm  
Mesures en cm  
Maße in cm

**F1** Laccato opaco  
Matt lacquered  
Laqué mat  
Matt lackiert

**F2** Laccato lucido  
Glossy lacquered  
Laqué brillant  
Hochglanz lackiert

**F3** Nobilitati  
Veneer wood  
Placage bois  
Beschichtetes Holz

**F4** Arock®  
Arock®  
Arock®  
Arock®

**F5** abitat / vogue  
abitat / vogue  
abitat / vogue  
abitat / vogue



# Basi Units

# Meubles bas Unterschränke

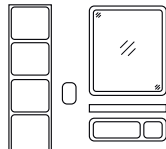

UNICAMENTE  
AROCK®

34

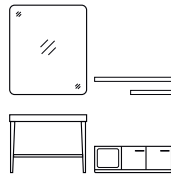

ALCENTIMETRO  
PROGETTO

98

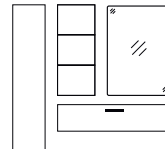

Elementi  
CONTENITORI

180

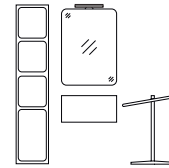

Elementi  
COMPLEMENTARI

226



RICAMBI

592

## H 87

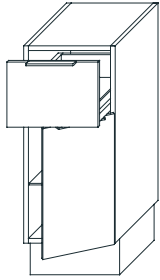

## P 45

Maniglia FILO & chiusura ammortizzata • base laterale dx • 1 cassetto + 1 anta + 1 ripiano • zoccolo H 12 incl.  
 FILO Handle & soft-closing • side unit • 1 pull-out + 1 door + 1 shelf • toe-kick H 12 incl.  
 Poignée FILO & fermeture amortie • meuble bas latéral • 1 tiroir + 1 porte + 1 étagère • socle H 12 incl.  
 FILO Griff • Seitenschrank • 1 Soft-Closing Schublade + 1 Tür + 1 Regal • Sockel H 12 inkl.

L		F1	F2	F3
30	N2B03038			
35	N2B03538			
45	N2B04538			

## P 51,5

L		F1	F2	F3
30	N2B03088			
35	N2B03588			
45	N2B04588			

## H 87

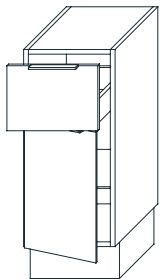

## P 45

Maniglia FILO & chiusura ammortizzata • base laterale sx • 1 cassetto + 1 anta + 1 ripiano • zoccolo H 12 incl.  
 FILO Handle & soft-closing • side unit • 1 pull-out + 1 door + 1 shelf • toe-kick H 12 incl.  
 Poignée FILO & fermeture amortie • meuble bas latéral • 1 tiroir + 1 porte + 1 étagère • socle H 12 incl.  
 FILO Griff • Seitenschrank • 1 Soft-Closing Schublade + 1 Tür + 1 Regal • Sockel H 12 inkl.

L		F1	F2	F3
30	N2B03039			
35	N2B03539			
45	N2B04539			

## P 51,5

L		F1	F2	F3
30	N2B03089			
35	N2B03589			
45	N2B04589			

## H 87

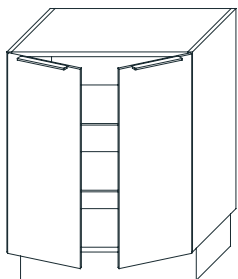

## P 45

Maniglia FILO & chiusura ammortizzata • base laterale • 2 ante + 2 ripiani  
 FILO Handle & soft-closing • side unit • 2 doors + 2 shelves  
 Poignée FILO & fermeture amortie • meuble bas latéral • 2 portes + 2 étagères  
 FILO Griff • Seitenschrank • 2 Türen + 2 Regale

L		F1	F2	F3
50	N2B05041			
60	N2B06041			
70	N2B07041			
90	N2B09041			

## P 51,5

L		F1	F2	F3
50	N2B05091			
60	N2B06091			
70	N2B07091			
90	N2B09091			

H  
L  
P

Misure in cm  
 Measures in cm  
 Mesures en cm  
 Maße in cm

**F1** Laccato opaco  
 Matt lacquered  
 Laqué mat  
 Matt lackiert

**F2** Laccato lucido  
 Glossy lacquered  
 Laqué brillant  
 Hochglanz lackiert

**F3** Nobilitati  
 Veneer wood  
 Placage bois  
 Beschichtetes Holz

**F4** Arock®  
 Arock®  
 Arock®  
 Arock®

**F5** abitat / vogue  
 abitat / vogue  
 abitat / vogue  
 abitat / vogue

## Basi Units

## Meubles bas Unterschränke

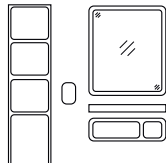

UNICAMENTE  
AROCK®

34



ALCENTIMETRO  
PROGETTO

98

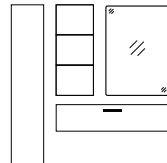

Elementi  
CONTENITORI

180

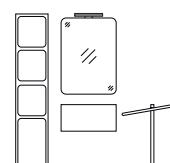

Elementi  
COMPLEMENTARI

226



RICAMBI

592

### H 87

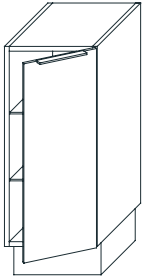

### P 45

Maniglia FILO & chiusura ammortizzata • base laterale dx • 1 anta + 2 ripiani • zoccolo H 12 incl.  
FILO Handle & soft-closing • side unit • 1 door + 2 shelves • toe-kick H 12 incl.  
Poignée FILO & fermeture amortie • meuble bas latéral • 1 porte + 2 étagères • socle H 12 incl.  
FILO Griff • Seitenschrank • 1 Tür + 2 Regale • Sockel H 12 inkl.

L		F1	F2	F3
30	N2B03042			
35	N2B03542			
45	N2B04542			

### P 51,5

L		F1	F2	F3
30	N2B03092			
35	N2B03592			
45	N2B04592			

### H 87

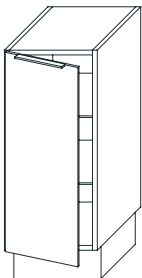

### P 45

Maniglia FILO & chiusura ammortizzata • base laterale sx • 1 anta + 2 ripiani • zoccolo H 12 incl.  
FILO Handle & soft-closing • side unit • 1 door + 2 shelves • toe-kick H 12 incl.  
Poignée FILO & fermeture amortie • meuble bas latéral • 1 porte + 2 étagères • socle H 12 incl.  
FILO Griff • Seitenschrank • 1 Tür + 2 Regale • Sockel H 12 inkl.

L		F1	F2	F3
30	N2B03043			
35	N2B03543			
45	N2B04543			

### P 51,5

L		F1	F2	F3
30	N2B03093			
35	N2B03593			
45	N2B04593			

### H 87

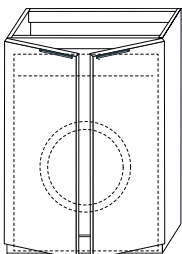

### P 51,5

Maniglia FILO & chiusura ammortizzata • base laterale per lavatrice • 2 ante • zoccolo H 12 incl.  
FILO Handle & soft-closing • washer side unit • 2 doors • toe-kick H 12 incl.  
Poignée FILO & fermeture amortie • meuble bas latéral pour laveuse • 2 portes • socle H 12 incl.  
FILO Griff • Seitenschrank für Waschmaschine • 2 Türen • Sockel H 12 inkl.

L		F1	F2	F3
70	N2W07054			

### P 65

L		F1	F2	F3
70	N2W07094			

H  
L  
P

Misure in cm  
Measures in cm  
Mesures en cm  
Maße in cm

**F1** Laccato opaco  
Matt lacquered  
Laqué mat  
Matt lackiert

**F2** Laccato lucido  
Glossy lacquered  
Laqué brillant  
Hochglanz lackiert





**F3** Nobilitati  
Veneer wood  
Placage bois  
Beschichtetes Holz

**F4** Arock®  
Arock®  
Arock®  
Arock®

**F5** abitat / vogue  
abitat / vogue  
abitat / vogue  
abitat / vogue

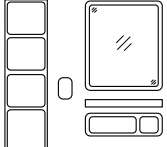
## Basi Units

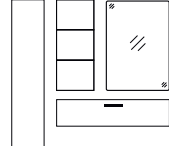
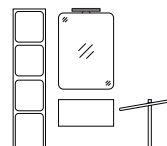
## Meubles bas Unterschränke

				
UNICAMENTE AROCK®	ALCENTIMETRO PROGETTO	Elementi CONTENITORI	Elementi COMPLEMENTARI	RICAMBI
34	98	180	226	592

### H 87

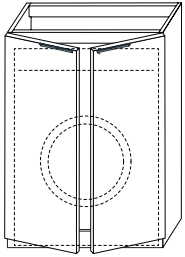

### P 51,5

Maniglia FILO & chiusura ammortizzata • base laterale per asciugatrice • 2 ante • zoccolo H 12 incl.  
 FILO Handle & soft-closing • dryer side unit • 2 doors • toe-kick H 12 incl.  
 Poignée FILO & fermeture amortie • meuble bas latéral pour sècheuse • 2 portes • socle H 12 incl.  
 FILO Griff • Seitenschrank für Trockner • 2 Türen • Sockel H 12 inkl.

**L**  
70 N2W07056

**F1**

**F2**

**F3**

### P 65

**L**  
70 N2W07096

**F1**

**F2**

**F3**



Misure in cm  
Measures in cm  
Mesures en cm  
Maße in cm

**F1** Laccato opaco  
Matt lacquered  
Laqué mat  
Matt lackiert

**F2** Laccato lucido  
Glossy lacquered  
Laqué brillant  
Hochglanz lackiert

**F3** Nobilitati  
Veneer wood  
Placage bois  
Beschichtetes Holz

**F4** Arock®  
Arock®  
Arock®  
Arock®

**F5** abitat / vogue  
abitat / vogue  
abitat / vogue  
abitat / vogue

# Basi Units

# Meubles bas Unterschränke

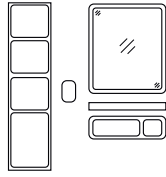

UNICAMENTE  
AROCK®

34

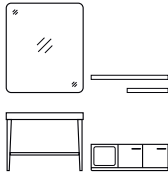

ALCENTIMETRO  
PROGETTO

98

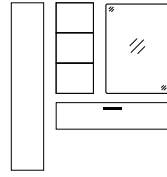

Elementi  
CONTENITORI

180

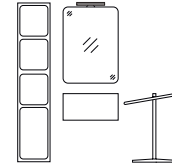

Elementi  
COMPLEMENTARI

226



RICAMBI

592

## H 25

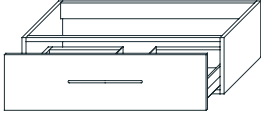

## P 45

Maniglia PONTE & chiusura ammortizzata • base portalavabo • 1 cassetto • sifone incl.  
 PONTE Handle & soft-closing • vanity unit • 1 pull-out • siphon incl.  
 Poignée PONTE & fermeture amortie • meuble sous vasque • 1 tiroir • siphon incl.  
 PONTE Griff • Waschtischunterschrank • 1 Soft-Closing Schublade • Siphon inkl.

L		F1	F2	F3
60	N4L06001			
70	N4L07001			
80	N4L08001			
90	N4L09001			
105	N4L10501			
120	N4L12001			

## P 51,5

L		F1	F2	F3
60	N4L06051			
70	N4L07051			
80	N4L08051			
90	N4L09051			
105	N4L10551			
120	N4L12051			

## H 25

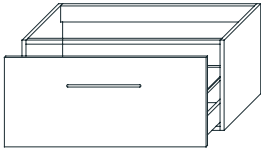

## P 45

Maniglia PONTE & chiusura ammortizzata • base portalavabo • 1 cassetto • scasso per sifone in posizione variabile  
 PONTE Handle & soft-closing • vanity unit • 1 pull-out • cavity for siphon in variable position  
 Poignée PONTE & fermeture amortie • meuble sous vasque • 1 tiroir • trou pour le siphon en position variable  
 PONTE Griff • Waschtischunterschrank • 1 Soft-Closing Schublade • Siphonousschnitt

L		F1	F2	F3
105	N4L10502			
120	N4L12002			

## P 51,5

L		F1	F2	F3
105	N4L10552			
120	N4L12052			

## H 25

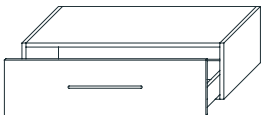

## P 45

Maniglia PONTE & chiusura ammortizzata • base laterale • 1 cassetto  
 PONTE Handle & soft-closing • side unit • 1 pull-out  
 Poignée PONTE & fermeture amortie • meuble bas latéral • 1 tiroir  
 PONTE Griff • Seitenschrank • 1 Soft-Closing Schublade

L		F1	F2	F3
30	N4B03001			
35	N4B03501			
45	N4B04501			
50	N4B05001			
60	N4B06001			
70	N4B07001			
90	N4B09001			
105	N4B10501			
120	N4B12001			

## P 51,5

L		F1	F2	F3
30	N4B03051			
35	N4B03551			
45	N4B04551			
50	N4B05051			
60	N4B06051			
70	N4B07051			
90	N4B09051			
105	N4B10551			
120	N4B12051			



Misure in cm  
 Measures in cm  
 Mesures en cm  
 Maße in cm

**F1** Laccato opaco  
 Matt lacquered  
 Laqué mat  
 Matt lackiert

**F2** Laccato lucido  
 Glossy lacquered  
 Laqué brillant  
 Hochglanz lackiert





**F3** Nobilitati  
 Veneer wood  
 Placage bois  
 Beschichtetes Holz

**F4** Arock®  
 Arock®  
 Arock®  
 Arock®

**F5** abitat / vogue  
 abitat / vogue  
 abitat / vogue  
 abitat / vogue

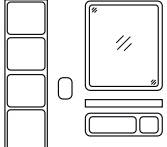
# Basi Units

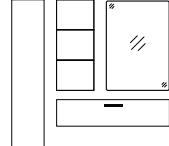
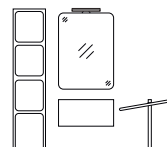
# Meubles bas Unterschränke

				
UNICAMENTE AROCK®	ALCENTIMETRO PROGETTO	Elementi CONTENITORI	Elementi COMPLEMENTARI	RICAMBI
34	98	180	226	592

## H 25

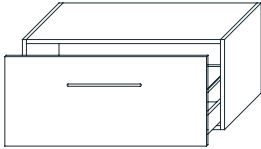

## P 45

Maniglia PONTE & chiusura ammortizzata • base laterale • 1 cassetto • scasso per sifone in posizione variabile  
 PONTE Handle & soft-closing • side unit • 1 pull-out • cavity for siphon in variable position  
 Poignée PONTE & fermeture amortie • meuble bas latéral • 1 tiroir • trou pour le siphon en position variable  
 PONTE Griff • Seitenschrank • 1 Soft-Closing Schublade • Siphonousschnitt

L		F1	F2	F3
105	N4B10502			
120	N4B12002			

## P 51,5

L		F1	F2	F3
105	N4B10552			
120	N4B12052			

## H 40

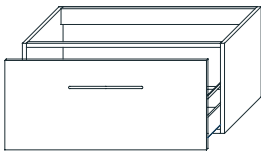

## P 45

Maniglia PONTE & chiusura ammortizzata • base portalavabo • 1 cassetto • sifone incl.  
 PONTE Handle & soft-closing • vanity unit • 1 pull-out • siphon incl.  
 Poignée PONTE & fermeture amortie • meuble sous vasque • 1 tiroir • siphon incl.  
 PONTE Griff • Waschtischunterschrank • 1 Soft-Closing Schublade • Siphon inkl.

L		F1	F2	F3
60	N4L06004			
70	N4L07004			
80	N4L08004			
90	N4L09004			
105	N4L10504			
120	N4L12004			

## P 51,5

L		F1	F2	F3
60	N4L06054			
70	N4L07054			
80	N4L08054			
90	N4L09054			
105	N4L10554			
120	N4L12054			

## H 40

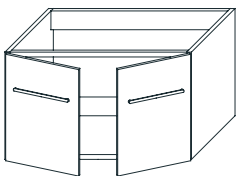

## P 45

Maniglia PONTE & chiusura ammortizzata • base portalavabo • 2 ante • sifone incl.  
 PONTE Handle & soft-closing • vanity unit • 2 doors • siphon incl.  
 Poignée PONTE & fermeture amortie • meuble sous vasque • 2 portes • siphon incl.  
 PONTE Griff • Waschtischunterschrank • 2 Türen • Siphon inkl.

L		F1	F2	F3
60	N4L06005			
70	N4L07005			
80	N4L08005			
90	N4L09005			

## P 51,5

L		F1	F2	F3
60	N4L06055			
70	N4L07055			
80	N4L08055			
90	N4L09055			

 Misure in cm  
 Measures in cm  
 Mesures en cm  
 Maße in cm

**F1** Laccato opaco  
Matt lacquered  
Laqué mat  
Matt lackiert

**F2** Laccato lucido  
Glossy lacquered  
Laqué brillant  
Hochglanz lackiert

**F3** Nobilitati  
Veneer wood  
Placage bois  
Beschichtetes Holz

**F4** Arock®  
Arock®  
Arock®  
Arock®

**F5** abitat / vogue  
abitat / vogue  
abitat / vogue  
abitat / vogue

# Basi Units

# Meubles bas Unterschränke

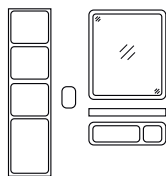

UNICAMENTE  
AROCK®

34

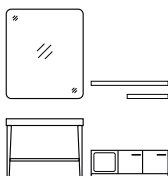

ALCENTIMETRO  
PROGETTO

98

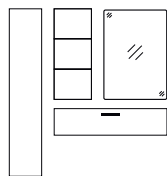

Elementi  
CONTENITORI

180

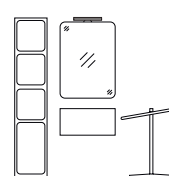

Elementi  
COMPLEMENTARI

226



RICAMBI

592

## H 40

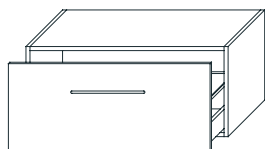

## P 45

Maniglia PONTE & chiusura ammortizzata • base laterale • 1 cassetto  
PONTE Handle & soft-closing • side unit • 1 pull-out  
Poignée PONTE & fermeture amortie • meuble bas latéral • 1 tiroir  
PONTE Griff • Seitenschrank • 1 Soft-Closing Schublade

L		F1	F2	F3
30	N4B03007			
35	N4B03507			
45	N4B04507			
50	N4B05007			
60	N4B06007			
70	N4B07007			
90	N4B09007			
105	N4B10507			
120	N4B12007			

## P 51,5

L		F1	F2	F3
30	N4B03057			
35	N4B03557			
45	N4B04557			
50	N4B05057			
60	N4B06057			
70	N4B07057			
90	N4B09057			
105	N4B10557			
120	N4B12057			

## H 40

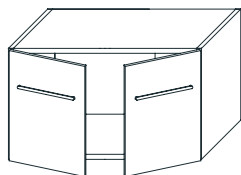

## P 45

Maniglia PONTE & chiusura ammortizzata • base laterale • 2 ante  
PONTE Handle & soft-closing • side unit • 2 doors  
Poignée PONTE & fermeture amortie • meuble bas latéral • 2 portes  
PONTE Griff • Seitenschrank • 2 Türen

L		F1	F2	F3
50	N4B05010			
60	N4B06010			
70	N4B07010			
90	N4B09010			

## P 51,5

L		F1	F2	F3
50	N4B05060			
60	N4B06060			
70	N4B07060			
90	N4B09060			

## H 40

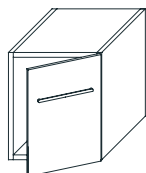

## P 45

Maniglia PONTE & chiusura ammortizzata • base laterale dx • 1 ante  
PONTE Handle & soft-closing • side unit • 1 door  
Poignée PONTE & fermeture amortie • meuble bas latéral • 1 porte  
PONTE Griff • Seitenschrank • 1 Tür

L		F1	F2	F3
30	N4B03008			
35	N4B03508			
45	N4B04508			

## P 51,5

L		F1	F2	F3
30	N4B03058			
35	N4B03558			
45	N4B04558			



Misure in cm  
Measures in cm  
Mesures en cm  
Maße in cm

**F1** Laccato opaco  
Matt lacquered  
Laqué mat  
Matt lackiert

**F2** Laccato lucido  
Glossy lacquered  
Laqué brillant  
Hochglanz lackiert



**F3** Nobilitati  
Veneer wood  
Placage bois  
Beschichtetes Holz

**F4** Arock®  
Arock®  
Arock®  
Arock®

**F5** abitat / vogue  
abitat / vogue  
abitat / vogue  
abitat / vogue

# Basi Units

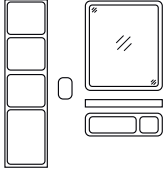
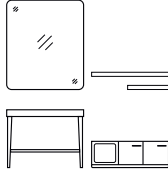
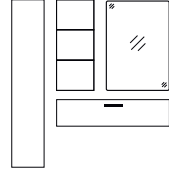
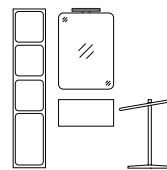
# Meubles bas Unterschränke

 UNICAMENTE AROCK®	 ALCENTIMETRO PROGETTO	 Elementi CONTENITORI	 Elementi COMPLEMENTARI	 RICAMBI
34	98	180	226	592

## H 40

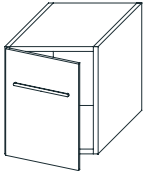

## P 45

Maniglia PONTE & chiusura ammortizzata • base laterale sx • 1 anta  
 PONTE Handle & soft-closing • side unit • 1 door  
 Poignée PONTE & fermeture amortie • meuble bas latéral • 1 porte  
 PONTE Griff • Seitenschrank • 1 Tür

L		F1	F2	F3
30	N4B03009			
35	N4B03509			
45	N4B04509			

## P 51,5

L		F1	F2	F3
30	N4B03059			
35	N4B03559			
45	N4B04559			

## H 50

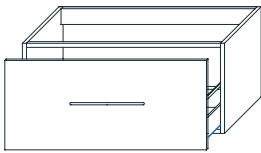

## P 45

Maniglia PONTE & chiusura ammortizzata • base portalavabo • 1 cassetto  
 PONTE Handle & soft-closing • vanity unit • 1 pull out  
 Poignée PONTE & fermeture amortie • meuble sous vasque • 1 tiroir  
 PONTE Griff • Waschtischunterschrank • 1 Soft-Closing Schublade

L		F1	F2	F3
60	N4L06019			
70	N4L07019			
80	N4L08019			
90	N4L09019			

## P 51,5

L		F1	F2	F3
60	N4L06069			
70	N4L07069			
80	N4L08069			
90	N4L09069			

## H 50

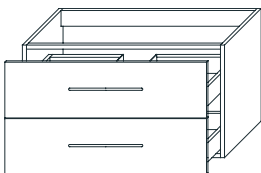

## P 45

Maniglia PONTE & chiusura ammortizzata • base portalavabo • 2 cassetti • sifone incl.  
 PONTE Handle & soft-closing • vanity unit • 2 pull-out • siphon incl.  
 Poignée PONTE & fermeture amortie • meuble sous vasque • 2 tiroirs • siphon incl.  
 PONTE Griff • Waschtischunterschrank • 2 Soft-Closing Schubladen • Siphon inkl.

L		F1	F2	F3
60	N4L06012			
70	N4L07012			
80	N4L08012			
90	N4L09012			
105	N4L10512			
120	N4L12012			

## P 51,5

L		F1	F2	F3
60	N4L06062			
70	N4L07062			
80	N4L08062			
90	N4L09062			
105	N4L10562			
120	N4L12062			

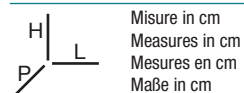

Misure in cm  
 Measures in cm  
 Mesures en cm  
 Maße in cm

**F1** Laccato opaco  
 Matt lacquered  
 Laqué mat  
 Matt lackiert

**F2** Laccato lucido  
 Glossy lacquered  
 Laqué brillant  
 Hochglanz lackiert

**F3** Nobilitati  
 Veneer wood  
 Placage bois  
 Beschichtetes Holz

**F4** Arock®  
 Arock®  
 Arock®  
 Arock®

**F5** abitat / vogue  
 abitat / vogue  
 abitat / vogue  
 abitat / vogue

**Basi  
Units**

**Meubles bas  
Unterschranke**

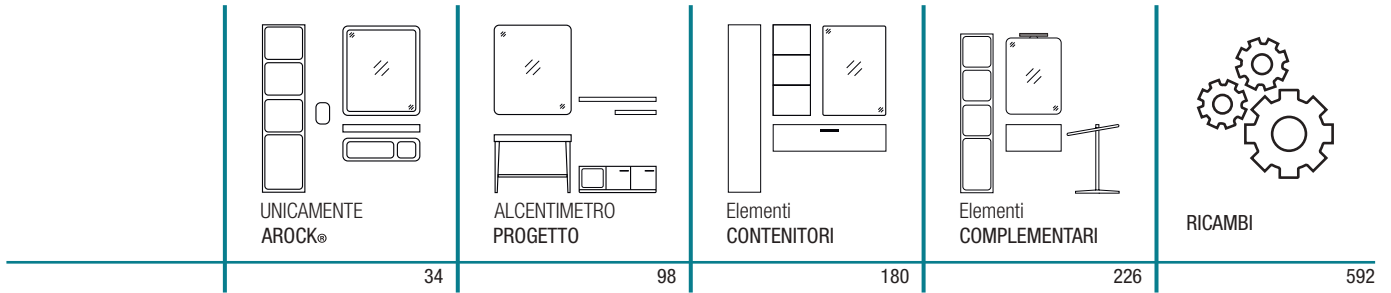

**H 50**

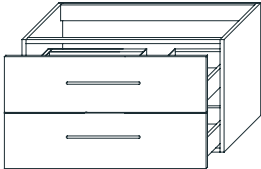

**P 45**

Maniglia PONTE & chiusura ammortizzata • base portalavabo • 2 cassetti • scasso per sifone dx  
 PONTE Handle & soft-closing • vanity unit • 2 pull-out • right cavity for siphon  
 Poignée PONTE & fermeture amortie • meuble sous vasque • 2 tiroirs • trou droite pour le siphon  
 PONTE Griff • Waschtischunterschrank • 2 Soft-Closing Schubladen • Siphonousschnitt-rechts

<b>L</b>	<b>F1</b>	<b>F2</b>	<b>F3</b>
105 N4L10516			

**P 51,5**

<b>L</b>	<b>F1</b>	<b>F2</b>	<b>F3</b>
105 N4L10566			

**H 50**

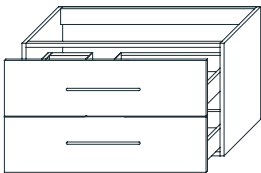

**P 45**

Maniglia PONTE & chiusura ammortizzata • base portalavabo • 2 cassetti • scasso per sifone sx  
 PONTE Handle & soft-closing • vanity unit • 2 pull-out • left cavity for siphon  
 Poignée PONTE & fermeture amortie • meuble sous vasque • 2 tiroirs • trou gauche pour le siphon  
 PONTE Griff • Waschtischunterschrank • 2 Soft-Closing Schubladen • Siphonousschnitt-links

<b>L</b>	<b>F1</b>	<b>F2</b>	<b>F3</b>
105 N4L10517			

**P 51,5**

<b>L</b>	<b>F1</b>	<b>F2</b>	<b>F3</b>
105 N4L10567			

**H 50**

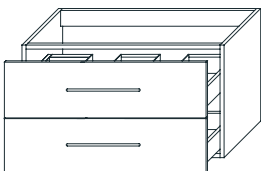

**P 45**

Maniglia PONTE & chiusura ammortizzata • base portalavabo • 2 cassetti • scasso per sifone doppio  
 PONTE Handle & soft-closing • vanity unit • 2 pull-out • double cavity for siphon  
 Poignée PONTE & fermeture amortie • meuble sous vasque • 2 tiroirs • trou pour le siphon double  
 PONTE Griff • Waschtischunterschrank • 2 Soft-Closing Schubladen • Siphonousschnitt-doppelt

<b>L</b>	<b>F1</b>	<b>F2</b>	<b>F3</b>
120 N4L12011			

**P 51,5**

<b>L</b>	<b>F1</b>	<b>F2</b>	<b>F3</b>
120 N4L12061			



Misure in cm  
 Measures in cm  
 Mesures en cm  
 Maße in cm

**F1** Laccato opaco  
 Matt lacquered  
 Laqué mat  
 Matt lackiert

**F2** Laccato lucido  
 Glossy lacquered  
 Laqué brillant  
 Hochglanz lackiert

**F3** Nobilitati  
 Veneer wood  
 Placage bois  
 Beschichtetes Holz





**F4** Arock®  
 Arock®  
 Arock®  
 Arock®

**F5** abitat / vogue  
 abitat / vogue  
 abitat / vogue  
 abitat / vogue

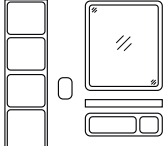

## Basi Units

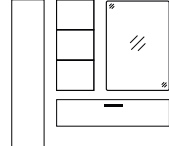
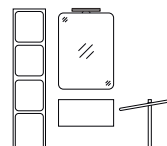
## Meubles bas Unterschränke

				
UNICAMENTE AROCK®	ALCENTIMETRO PROGETTO	Elementi CONTENITORI	Elementi COMPLEMENTARI	RICAMBI
34	98	180	226	592

### H 50

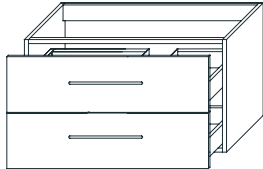

### P 45

Maniglia PONTE & chiusura ammortizzata • base portalavabo • 2 cassetti • scasso per sifone dx  
 PONTE Handle & soft-closing • vanity unit • 2 pull-out • right cavity for siphon  
 Poignée PONTE & fermeture amortie • meuble sous vasque • 2 tiroirs • trou droite pour le siphon  
 PONTE Griff • Waschtischunterschrank • 2 Soft-Closing Schubladen • Siphonousschnitt-rechts

L	F1	F2	F3
120 N4L12014			

### P 51,5

L	F1	F2	F3
120 N4L12064			

### H 50

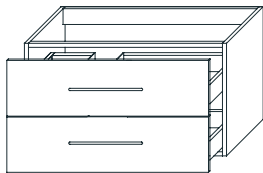

### P 45

Maniglia PONTE & chiusura ammortizzata • base portalavabo • 2 cassetti • scasso per sifone sx  
 PONTE Handle & soft-closing • vanity unit • 2 pull-out • left cavity for siphon  
 Poignée PONTE & fermeture amortie • meuble sous vasque • 2 tiroirs • trou gauche pour le siphon  
 PONTE Griff • Waschtischunterschrank • 2 Soft-Closing Schubladen • Siphonousschnitt-links

L	F1	F2	F3
120 N4L12015			

### P 51,5

L	F1	F2	F3
120 N4L12065			

### H 50

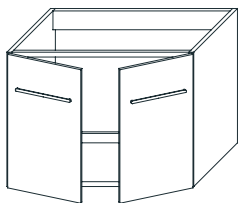

### P 45

Maniglia PONTE & chiusura ammortizzata • base portalavabo • 2 ante • sifone incl.  
 PONTE Handle & soft-closing • vanity unit • 2 doors • siphon incl.  
 Poignée PONTE & fermeture amortie • meuble sous vasque • 2 portes • siphon incl.  
 PONTE Griff • Waschtischunterschrank • 2 Türen • Siphon inkl.

L	F1	F2	F3
60 N4L06013			
70 N4L07013			
80 N4L08013			
90 N4L09013			

### P 51,5

L	F1	F2	F3
60 N4L06063			
70 N4L07063			
80 N4L08063			
90 N4L09063			

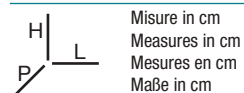

Misure in cm  
 Measures in cm  
 Mesures en cm  
 Maße in cm

**F1** Laccato opaco  
 Matt lacquered  
 Laqué mat  
 Matt lackiert

**F2** Laccato lucido  
 Glossy lacquered  
 Laqué brillant  
 Hochglanz lackiert

**F3** Nobilitati  
 Veneer wood  
 Placage bois  
 Beschichtetes Holz

**F4** Arock®  
 Arock®  
 Arock®  
 Arock®

**F5** abitat / vogue  
 abitat / vogue  
 abitat / vogue  
 abitat / vogue





# Basi Units

# Meubles bas Unterschränke

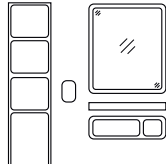

UNICAMENTE  
AROCK®

34

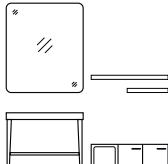

ALCENTIMETRO  
PROGETTO

98

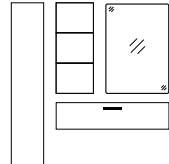

Elementi  
CONTENITORI

180

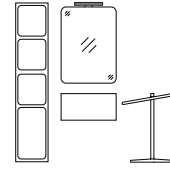

Elementi  
COMPLEMENTARI

226



RICAMBI

592

## H 50

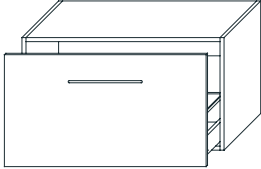

## P 45

Maniglia PONTE & chiusura ammortizzata • base laterale • 1 cassetto + 1 ripiano  
 PONTE Handle & soft-closing • side unit • 1 pull-out + 1 shelf  
 Poignée PONTE & fermeture amortie • meuble bas latéral • 1 tiroir + 1 étagère  
 PONTE Griff • Seitenschrank • 1 Soft-Closing Schublade + 1 Regal

L		F1	F2	F3
30	N4B03019			
35	N4B03519			
45	N4B04519			
50	N4B05019			
60	N4B06019			
70	N4B07019			
90	N4B09019			
105	N4B10519			
120	N4B12019			

## P 51,5

L		F1	F2	F3
30	N4B03069			
35	N4B03569			
45	N4B04569			
50	N4B05069			
60	N4B06069			
70	N4B07069			
90	N4B09069			
105	N4B10569			
120	N4B12069			

## H 50

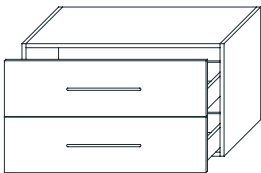

## P 45

Maniglia PONTE & chiusura ammortizzata • base laterale • 2 cassetti  
 PONTE Handle & soft-closing • side unit • 2 pull-out  
 Poignée PONTE & fermeture amortie • meuble bas latéral • 2 tiroirs  
 PONTE Griff • Seitenschrank • 2 Soft-Closing Schubladen

L		F1	F2	F3
30	N4B03012			
35	N4B03512			
45	N4B04512			
50	N4B05012			
60	N4B06012			
70	N4B07012			
90	N4B09012			
105	N4B10512			
120	N4B12012			

## P 51,5

L		F1	F2	F3
30	N4B03062			
35	N4B03562			
45	N4B04562			
50	N4B05062			
60	N4B06062			
70	N4B07062			
90	N4B09062			
105	N4B10562			
120	N4B12062			

## H 50

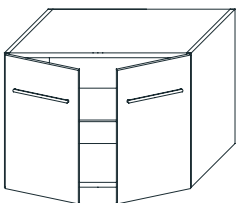

## P 45

Maniglia PONTE & chiusura ammortizzata • base laterale • 2 ante + 1 ripiano  
 PONTE Handle & soft-closing • side unit • 2 doors + 1 shelf  
 Poignée PONTE & fermeture amortie • meuble bas latéral • 2 portes + 1 étagère  
 PONTE Griff • Seitenschrank • 2 Türen + 1 Regal

L		F1	F2	F3
50	N4B05014			
60	N4B06014			
70	N4B07014			
90	N4B09014			

## P 51,5

L		F1	F2	F3
50	N4B05064			
60	N4B06064			
70	N4B07064			
90	N4B09064			



Misure in cm  
 Measures in cm  
 Mesures en cm  
 Maße in cm

**F1** Laccato opaco  
 Matt lacquered  
 Laqué mat  
 Matt lackiert

**F2** Laccato lucido  
 Glossy lacquered  
 Laqué brillant  
 Hochglanz lackiert





**F3** Nobilitati  
 Veneer wood  
 Placage bois  
 Beschichtetes Holz

**F4** Arock®  
 Arock®  
 Arock®  
 Arock®

**F5** abitat / vogue  
 abitat / vogue  
 abitat / vogue  
 abitat / vogue

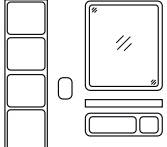
# Basi Units

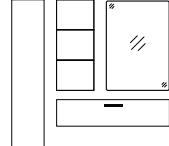
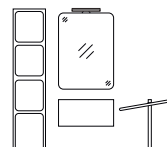
# Meubles bas Unterschränke

				
UNICAMENTE AROCK®	ALCENTIMETRO PROGETTO	Elementi CONTENITORI	Elementi COMPLEMENTARI	RICAMBI
34	98	180	226	592

## H 50

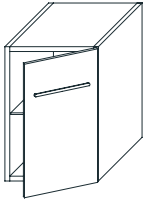

## P 45

Maniglia PONTE & chiusura ammortizzata • base laterale dx • 1 anta + 1 ripiano  
 PONTE Handle & soft-closing • side unit • 1 door + 1 shelf  
 Poignée PONTE & fermeture amortie • meuble bas latéral • 1 porte + 1 étagère  
 PONTE Griff • Seitenschrank • 1 Tür + 1 Regal

L		F1	F2	F3
30	N4B03016			
35	N4B03516			
45	N4B04516			

## P 51,5

L		F1	F2	F3
30	N4B03066			
35	N4B03566			
45	N4B04566			

## H 50

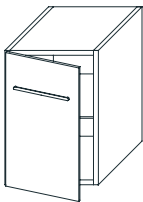

## P 45

Maniglia PONTE & chiusura ammortizzata • base laterale sx • 1 anta + 1 ripiano  
 PONTE Handle & soft-closing • side unit • 1 door + 1 shelf  
 Poignée PONTE & fermeture amortie • meuble bas latéral • 1 porte + 1 étagère  
 PONTE Griff • Seitenschrank • 1 Tür + 1 Regal

L		F1	F2	F3
30	N4B03017			
35	N4B03517			
45	N4B04517			

## P 51,5

L		F1	F2	F3
30	N4B03067			
35	N4B03567			
45	N4B04567			

## H 75

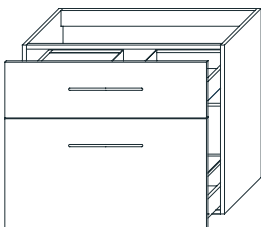

## P 45

Maniglia PONTE & chiusura ammortizzata • base portalavabo • 2 cassetti • sifone incl.  
 PONTE Handle & soft-closing • vanity unit • 2 pull-out • siphon incl.  
 Poignée PONTE & fermeture amortie • meuble sous vasque • 2 tiroirs • siphon incl.  
 PONTE Griff • Waschtischunterschrank • 2 Soft-Closing Schubladen • Siphon inkl.

L		F1	F2	F3
60	N4L06022			
70	N4L07022			
80	N4L08022			
90	N4L09022			
105	N4L10522			
120	N4L12022			

## P 51,5

L		F1	F2	F3
60	N4L06072			
70	N4L07072			
80	N4L08072			
90	N4L09072			
105	N4L10572			
120	N4L12072			

 Misure in cm  
 Measures in cm  
 Mesures en cm  
 Maße in cm

**F1** Laccato opaco  
 Matt lacquered  
 Laqué mat  
 Matt lackiert

**F2** Laccato lucido  
 Glossy lacquered  
 Laqué brillant  
 Hochglanz lackiert

**F3** Nobilitati  
 Veneer wood  
 Placage bois  
 Beschichtetes Holz

**F4** Arock®  
 Arock®  
 Arock®  
 Arock®

**F5** abitat / vogue  
 abitat / vogue  
 abitat / vogue  
 abitat / vogue

# Basi Units

# Meubles bas Unterschränke

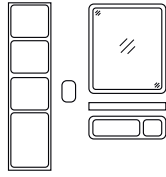

UNICAMENTE  
AROCK®

34

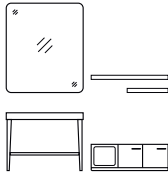

ALCENTIMETRO  
PROGETTO

98

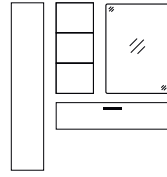

Elementi  
CONTENITORI

180

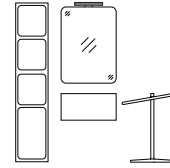

Elementi  
COMPLEMENTARI

226



RICAMBI

592

## H 75

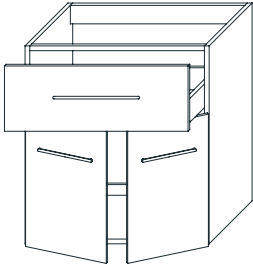

## P 45

Maniglia PONTE & chiusura ammortizzata • base portalavabo • 1 cassetto + 2 ante • sifone incl.  
 PONTE Handle & soft-closing • vanity unit • 1 pull-out + 2 doors • siphon incl.  
 Poignée PONTE & fermeture amortie • meuble sous vasque • 1 tiroir + 2 portes • siphon incl.  
 PONTE Griff • Waschtischunterschrank • 1 Soft-Closing Schublade + 2 Türen • Siphon inkl.

L		F1	F2	F3
60	N4L06023			
70	N4L07023			
80	N4L08023			
90	N4L09023			

## P 51,5

L		F1	F2	F3
60	N4L06073			
70	N4L07073			
80	N4L08073			
90	N4L09073			

## H 75

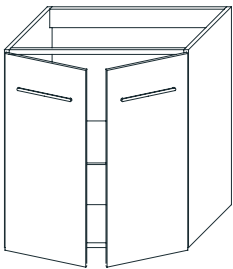

## P 45

Maniglia PONTE & chiusura ammortizzata • base portalavabo • 2 ante + 1 ripiano • sifone incl.  
 PONTE Handle & soft-closing • vanity unit • 2 doors + 1 shelf • siphon incl.  
 Poignée PONTE & fermeture amortie • meuble sous vasque • 2 portes + 1 étagère • siphon incl.  
 PONTE Griff • Waschtischunterschrank • 2 Türen + 1 Regal • Siphon inkl.

L		F1	F2	F3
60	N4L06024			
70	N4L07024			
80	N4L08024			
90	N4L09024			

## P 51,5

L		F1	F2	F3
60	N4L06074			
70	N4L07074			
80	N4L08074			
90	N4L09074			

## H 75

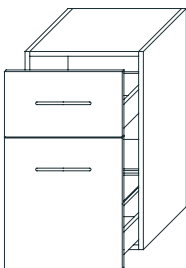

## P 45

Maniglia PONTE & chiusura ammortizzata • base laterale • 2 cassetti + 1 ripiano  
 PONTE Handle & soft-closing • side unit • 2 pull-out + 1 shelf  
 Poignée PONTE & fermeture amortie • meuble bas latéral • 2 tiroirs + 1 étagère  
 PONTE Griff • Seitenschrank • 2 Soft-Closing Schubladen + 1 Regal

L		F1	F2	F3
30	N4B03025			
35	N4B03525			
45	N4B04525			
50	N4B05025			
60	N4B06025			

## P 51,5

L		F1	F2	F3
30	N4B03075			
35	N4B03575			
45	N4B04575			
50	N4B05075			
60	N4B06075			



Misure in cm  
 Measures in cm  
 Mesures en cm  
 Maße in cm

**F1** Laccato opaco  
 Matt lacquered  
 Laqué mat  
 Matt lackiert

**F2** Laccato lucido  
 Glossy lacquered  
 Laqué brillant  
 Hochglanz lackiert

**F3** Nobilitati  
 Veneer wood  
 Placage bois  
 Beschichtetes Holz

**F4** Arock®  
 Arock®  
 Arock®  
 Arock®

**F5** abitat / vogue  
 abitat / vogue  
 abitat / vogue  
 abitat / vogue

# Basi Units

# Meubles bas Unterschränke

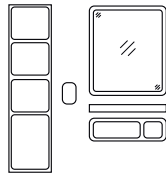

UNICAMENTE  
AROCK®

34

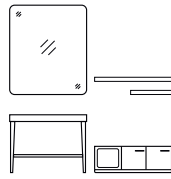

ALCENTIMETRO  
PROGETTO

98

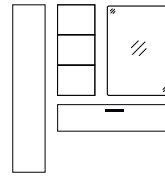

Elementi  
CONTENITORI

180

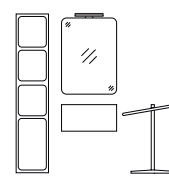

Elementi  
COMPLEMENTARI

226



RICAMBI

592

## H 75

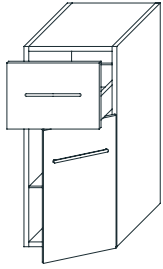

## P 45

Maniglia PONTE & chiusura ammortizzata • base laterale dx • 1 cassetto + 1 anta + 1 ripiano  
 PONTE Handle & soft-closing • side unit • 1 pull-out + 1 door + 1 shelf  
 Poignée PONTE & fermeture amortie • meuble bas latéral • 1 tiroir + 1 porte + 1 étagère  
 PONTE Griff • Seitenschrank • 1 Soft-Closing Schublade + 1 Tür + 1 Regal

L		F1	F2	F3
30	N4B03026			
35	N4B03526			
45	N4B04526			

## P 51,5

L		F1	F2	F3
30	N4B03076			
35	N4B03576			
45	N4B04576			

## H 75

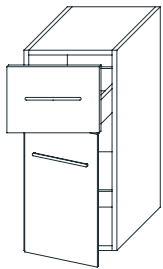

## P 45

Maniglia PONTE & chiusura ammortizzata • base laterale sx • 1 cassetto + 1 anta + 1 ripiano  
 PONTE Handle & soft-closing • side unit • 1 pull-out + 1 door + 1 shelf  
 Poignée PONTE & fermeture amortie • meuble bas latéral • 1 tiroir + 1 porte + 1 étagère  
 PONTE Griff • Seitenschrank • 1 Soft-Closing Schublade + 1 Tür + 1 Regal

L		F1	F2	F3
30	N4B03027			
35	N4B03527			
45	N4B04527			

## P 51,5

L		F1	F2	F3
30	N4B03077			
35	N4B03577			
45	N4B04577			

## H 75

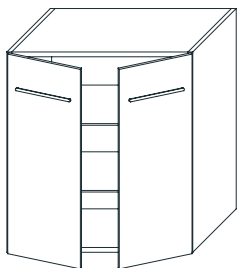

## P 45

Maniglia PONTE & chiusura ammortizzata • base laterale • 2 ante + 2 ripiani  
 PONTE Handle & soft-closing • side unit • 2 doors + 2 shelves  
 Poignée PONTE & fermeture amortie • meuble bas latéral • 2 portes + 2 étagères  
 PONTE Griff • Seitenschrank • 2 Türen + 2 Regale

L		F1	F2	F3
50	N4B05029			
60	N4B06029			
70	N4B07029			
90	N4B09029			

## P 51,5

L		F1	F2	F3
50	N4B05079			
60	N4B06079			
70	N4B07079			
90	N4B09079			

H  
L  
P

Misure in cm  
 Measures in cm  
 Mesures en cm  
 Maße in cm

**F1** Laccato opaco  
 Matt lacquered  
 Laqué mat  
 Matt lackiert

**F2** Laccato lucido  
 Glossy lacquered  
 Laqué brillant  
 Hochglanz lackiert

**F3** Nobilitati  
 Veneer wood  
 Placage bois  
 Beschichtetes Holz

**F4** Arock®  
 Arock®  
 Arock®  
 Arock®

**F5** abitat / vogue  
 abitat / vogue  
 abitat / vogue  
 abitat / vogue

# Basi Units

# Meubles bas Unterschränke

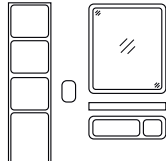

UNICAMENTE  
AROCK®

34



ALCENTIMETRO  
PROGETTO

98

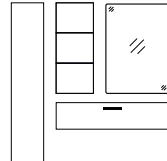

Elementi  
CONTENITORI

180

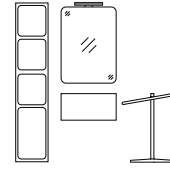

Elementi  
COMPLEMENTARI

226



RICAMBI

592

## H 75

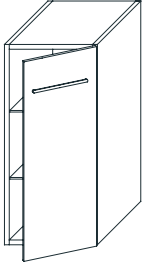

### P 45

Maniglia PONTE & chiusura ammortizzata • base laterale dx • 1 anta + 2 ripiani  
 PONTE Handle & soft-closing • side unit • 1 door + 2 shelves  
 Poignée PONTE & fermeture amortie • meuble bas latéral • 1 porte + 2 étagères  
 PONTE Griff • Seitenschrank • 1 Tür + 2 Regale

L		F1	F2	F3
30	N4B03030			
35	N4B03530			
45	N4B04530			

### P 51,5

L		F1	F2	F3
30	N4B03080			
35	N4B03580			
45	N4B04580			

## H 75

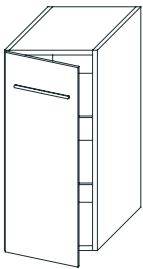

### P 45

Maniglia PONTE & chiusura ammortizzata • base laterale sx • 1 anta + 2 ripiani  
 PONTE Handle & soft-closing • side unit • 1 door + 2 shelves  
 Poignée PONTE & fermeture amortie • meuble sous vasque • 1 porte + 2 étagères  
 PONTE Griff • Seitenschrank • 1 Tür + 2 Regale

L		F1	F2	F3
30	N4B03031			
35	N4B03531			
45	N4B04531			

### P 51,5

L		F1	F2	F3
30	N4B03081			
35	N4B03581			
45	N4B04581			

## H 87

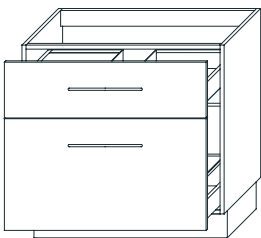

### P 45

Maniglia PONTE & chiusura ammortizzata • base portlavabo • 2 cassetti • zoccolo H 12 + sifone incl.  
 PONTE Handle & soft-closing • vanity unit • 2 pull-out • toe-kick H 12 + siphon incl.  
 Poignée PONTE & fermeture amortie • meuble sous vasque • 2 tiroirs • socle H 12 + socle incl.  
 PONTE Griff • Waschtischunterschrank • 2 Soft-Closing Schubladen • Sockel H 12 + Siphon inkl.

L		F1	F2	F3
60	N4L06034			
70	N4L07034			
80	N4L08034			
90	N4L09034			
105	N4L10534			
120	N4L12034			

### P 51,5

L		F1	F2	F3
60	N4L06084			
70	N4L07084			
80	N4L08084			
90	N4L09084			
105	N4L10584			
120	N4L12084			

H  
L  
P

Misure in cm  
 Measures in cm  
 Mesures en cm  
 Maße in cm

**F1** Laccato opaco  
 Matt lacquered  
 Laqué mat  
 Matt lackiert

**F2** Laccato lucido  
 Glossy lacquered  
 Laqué brillant  
 Hochglanz lackiert

**F3** Nobilitati  
 Veneer wood  
 Placage bois  
 Beschichtetes Holz





**F4** Arock®  
 Arock®  
 Arock®  
 Arock®

**F5** abitat / vogue  
 abitat / vogue  
 abitat / vogue  
 abitat / vogue

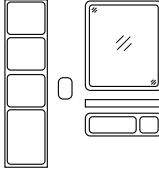

# Basi Units

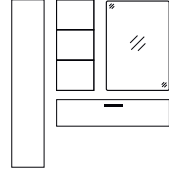
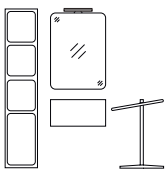
# Meubles bas Unterschränke

				
UNICAMENTE AROCK®	ALCENTIMETRO PROGETTO	Elementi CONTENITORI	Elementi COMPLEMENTARI	RICAMBI
34	98	180	226	592

## H 87

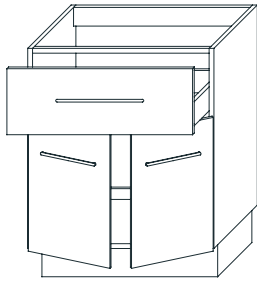

## P 45

Maniglia PONTE & chiusura ammortizzata • base portalavabo • 1 cassetto + 2 ante • zoccolo H 12 + sifone incl.  
 PONTE Handle & soft-closing • vanity unit • 1 pull-out + 2 doors • toe-kick H 12 + siphon incl.  
 Poignée PONTE & fermeture amortie • meuble sous vasque • 1 tiroir + 2 portes • socle H 12 + siphon incl.  
 PONTE Griff • Waschtischunterschrank • 1 Soft-Closing Schublade + 2 Türen • Sockel H 12 + Siphon inkl.

L		F1	F2	F3
60	N4L06035			
70	N4L07035			
80	N4L08035			
90	N4L09035			

## P 51,5

L		F1	F2	F3
60	N4L06085			
70	N4L07085			
80	N4L08085			
90	N4L09085			

## H 87

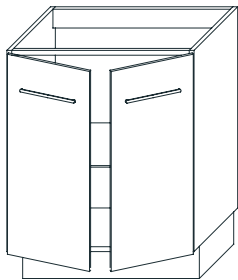

## P 45

Maniglia PONTE & chiusura ammortizzata • base portalavabo • 2 ante + 1 ripiano • zoccolo H 12 + sifone incl.  
 PONTE Handle & soft-closing • vanity unit • 2 doors + 1 shelf • toe-kick H 12 + siphon incl.  
 Poignée PONTE & fermeture amortie • meuble sous vasque • 2 portes + 1 étagère • socle H 12 + socle incl.  
 PONTE Griff • Waschtischunterschrank • 2 Türen + 1 Regal • Sockel H 12 + Siphon inkl.

L		F1	F2	F3
60	N4L06036			
70	N4L07036			
80	N4L08036			
90	N4L09036			

## P 51,5

L		F1	F2	F3
60	N4L06086			
70	N4L07086			
80	N4L08086			
90	N4L09086			

## H 87

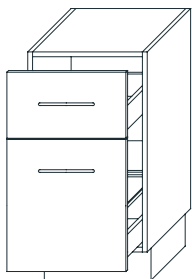

## P 45

Maniglia PONTE & chiusura ammortizzata • base laterale • 2 cassetti + 1 ripiano • zoccolo H 12 incl.  
 PONTE Handle & soft-closing • side unit • 2 pull-out + 1 shelf • toe-kick H 12 incl.  
 Poignée PONTE & fermeture amortie • meuble bas latéral • 2 tiroirs + 1 étagère • socle H 12 incl.  
 PONTE Griff • Seitenschrank • 2 Soft-Closing Schubladen + 1 Regal • Sockel H 12 inkl.

L		F1	F2	F3
30	N4B03037			
35	N4B03537			
45	N4B04537			
50	N4B05037			
60	N4B06037			

## P 51,5

L		F1	F2	F3
30	N4B03087			
35	N4B03587			
45	N4B04587			
50	N4B05087			
60	N4B06087			

H  
L  
P

Misure in cm  
Measures in cm  
Mesures en cm  
Maße in cm

**F1** Laccato opaco  
Matt lacquered  
Laqué mat  
Matt lackiert

**F2** Laccato lucido  
Glossy lacquered  
Laqué brillant  
Hochglanz lackiert

**F3** Nobilitati  
Veneer wood  
Placage bois  
Beschichtetes Holz

**F4** Arock®  
Arock®  
Arock®  
Arock®

**F5** abitat / vogue  
abitat / vogue  
abitat / vogue  
abitat / vogue

# Basi Units

# Meubles bas Unterschränke

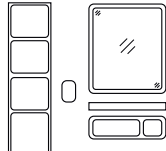

UNICAMENTE  
AROCK®

34



ALCENTIMETRO  
PROGETTO

98

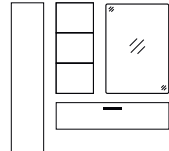

Elementi  
CONTENITORI

180

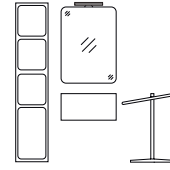

Elementi  
COMPLEMENTARI

226



RICAMBI

592

## H 87

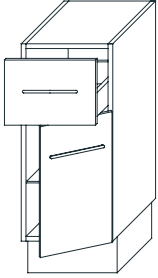

### P 45

Maniglia PONTE & chiusura ammortizzata • base laterale dx • 1 cassetto + 1 anta + 1 ripiano • zoccolo H 12 incl.  
 PONTE Handle & soft-closing • side unit • 1 pull-out + 1 door + 1 shelf • toe-kick H 12 incl.  
 Poignée PONTE & fermeture amortie • meuble bas latéral • 1 tiroir + 1 porte + 1 étagère • socle H 12 incl.  
 PONTE Griff • Seitenschrank • 1 Soft-Closing Schublade + 1 Tür + 1 Regal • Sockel H 12 inkl.

L		F1	F2	F3
30	N4B03038			
35	N4B03538			
45	N4B04538			

### P 51,5

L		F1	F2	F3
30	N4B03088			
35	N4B03588			
45	N4B04588			360

## H 87

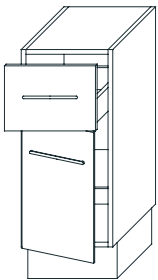

### P 45

Maniglia PONTE & chiusura ammortizzata • base laterale sx • 1 cassetto + 1 anta + 1 ripiano • zoccolo H 12 incl.  
 PONTE Handle & soft-closing • side unit • 1 pull-out + 1 door + 1 shelf • toe-kick H 12 incl.  
 Poignée PONTE & fermeture amortie • meuble bas latéral • 1 tiroir + 1 porte + 1 étagère • socle H 12 incl.  
 PONTE Griff • Seitenschrank • 1 Soft-Closing Schublade + 1 Tür + 1 Regal • Sockel H 12 inkl.

L		F1	F2	F3
30	N4B03039			
35	N4B03539			
45	N4B04539			

### P 51,5

L		F1	F2	F3
30	N4B03089			
35	N4B03589			
45	N4B04589			

## H 87

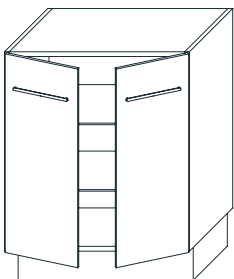

### P 45

Maniglia PONTE & chiusura ammortizzata • base laterale • 2 ante + 2 ripiani • zoccolo H 12 incl.  
 PONTE Handle & soft-closing • side unit • 2 doors + 2 shelves • toe-kick H 12 incl.  
 Poignée PONTE & fermeture amortie • meuble bas latéral • 2 portes + 2 étagères • socle H 12 incl.  
 PONTE Griff • Seitenschrank • 2 Türen + 2 Regale • Sockel H 12 inkl.

L		F1	F2	F3
50	N4B05041			
60	N4B06041			335
70	N4B07041			345
90	N4B09041			370

### P 51,5

L		F1	F2	F3
50	N4B05091			
60	N4B06091			
70	N4B07091			
90	N4B09091			

H  
L  
P

Misure in cm  
Measures in cm  
Mesures en cm  
Maße in cm

**F1** Laccato opaco  
Matt lacquered  
Laqué mat  
Matt lackiert

**F2** Laccato lucido  
Glossy lacquered  
Laqué brillant  
Hochglanz lackiert

**F3** Nobilitati  
Veneer wood  
Placage bois  
Beschichtetes Holz

**F4** Arock®  
Arock®  
Arock®  
Arock®

**F5** abitat / vogue  
abitat / vogue  
abitat / vogue  
abitat / vogue

# Basi Units

# Meubles bas Unterschränke

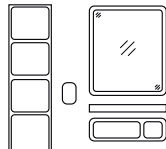

UNICAMENTE  
AROCK®

34

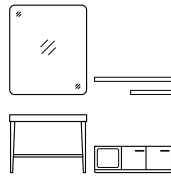

ALCENTIMETRO  
PROGETTO

98

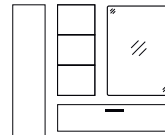

Elementi  
CONTENITORI

180

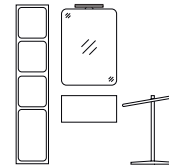

Elementi  
COMPLEMENTARI

226



RICAMBI

592

## H 87

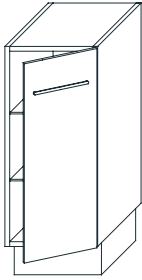

## P 45

Maniglia PONTE & chiusura ammortizzata • base laterale dx • 1 anta + 2 ripiani • zoccolo H 12 incl.  
 PONTE Handle & soft-closing • side unit • 1 door + 2 shelves • toe-kick H 12 incl.  
 Poignée PONTE & fermeture amortie • meuble bas latéral • 1 porte + 2 étagères • socle H 12 incl.  
 PONTE Griff • Seitenschrank • 1 Tür + 2 Regale • Sockel H 12 inkl.

L		F1	F2	F3
30	N4B03042			
35	N4B03542			
45	N4B04542			

## P 51,5

L		F1	F2	F3
30	N4B03092			
35	N4B03592			
45	N4B04592			

## H 87

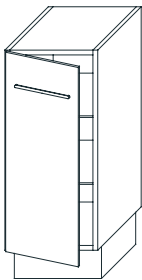

## P 45

Maniglia PONTE & chiusura ammortizzata • base laterale sx • 1 anta + 2 ripiani • zoccolo H 12 incl.  
 PONTE Handle & soft-closing • side unit • 1 door + 2 shelves • toe-kick H 12 incl.  
 Poignée PONTE & fermeture amortie • meuble bas latéral • 1 porte + 2 étagères • socle H 12 incl.  
 PONTE Griff • Seitenschrank • 1 Tür + 2 Regale • Sockel H 12 inkl.

L		F1	F2	F3
30	N4B03043			
35	N4B03543			
45	N4B04543			

## P 51,5

L		F1	F2	F3
30	N4B03093			
35	N4B03593			
45	N4B04593			

## H 87

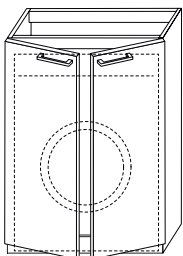

## P 51,5

Maniglia PONTE & chiusura ammortizzata • base laterale per lavatrice • 2 ante • zoccolo H 12 incl.  
 PONTE Handle & soft-closing • washer side unit • 2 doors • toe-kick H 12 incl.  
 Poignée PONTE & fermeture amortie • meuble bas latéral pour laveuse • 2 portes • socle H 12 incl.  
 PONTE Griff • Seitenschrank für Waschmaschine • 2 Türen • Sockel H 12 inkl.

L		F1	F2	F3
70	N4W07054			

## P 65

L		F1	F2	F3
70	N4W07094			

H  
L  
P

Misure in cm  
Measures in cm  
Mesures en cm  
Maße in cm

**F1** Laccato opaco  
Matt lacquered  
Laqué mat  
Matt lackiert

**F2** Laccato lucido  
Glossy lacquered  
Laqué brillant  
Hochglanz lackiert

**F3** Nobilitati  
Veneer wood  
Placage bois  
Beschichtetes Holz

**F4** Arock®  
Arock®  
Arock®  
Arock®

**F5** abitat / vogue  
abitat / vogue  
abitat / vogue  
abitat / vogue

## Basi Units

## Meubles bas Unterschränke

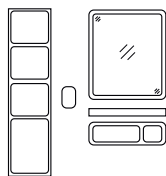

UNICAMENTE  
AROCK®

34

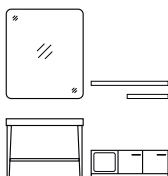

ALCENTIMETRO  
PROGETTO

98

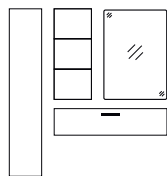

Elementi  
CONTENITORI

180

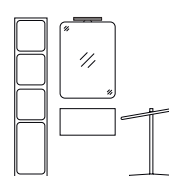

Elementi  
COMPLEMENTARI

226



RICAMBI

592

### H 87

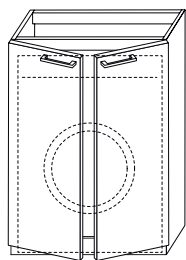

### P 51,5

Maniglia PONTE & chiusura ammortizzata • base laterale per asciugatrice • 2 ante • zoccolo H 12 incl.  
 PONTE Handle & soft-closing • dryer side unit • 2 doors • toe-kick H 12 incl.  
 Poignée PONTE & fermeture amortie • meuble bas latéral pour sècheuse • 2 portes • socle H 12 incl.  
 PONTE Griff • Seitenschrank für Trockner • 2 Türen • Socket H 12 inkl.

L

70 N4W07056

F1

F2

F3

### P 65

L

70 N4W07096

F1

F2

F3



Misure in cm  
 Measures in cm  
 Mesures en cm  
 Maße in cm

**F1** Laccato opaco  
 Matt lacquered  
 Laqué mat  
 Matt lackiert

**F2** Laccato lucido  
 Glossy lacquered  
 Laqué brillant  
 Hochglanz lackiert





**F3** Nobilitati  
 Veneer wood  
 Placage bois  
 Beschichtetes Holz

**F4** Arock®  
 Arock®  
 Arock®  
 Arock®

**F5** abitat / vogue  
 abitat / vogue  
 abitat / vogue  
 abitat / vogue

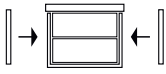
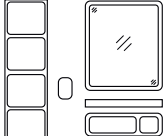
# Basi Units

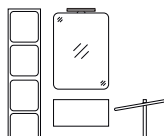
# Meubles bas Unterschränke

					
Terminale di finitura FACOLTATIVO	UNICAMENTE AROCK®	ALCENTIMETRO PROGETTO	Elementi CONTENITORI	Elementi COMPLEMENTARI	RICAMBI
507	34	98	180	226	592

## H 25



## P 45

Smusso 45° & chiusura ammortizzata • base portalavabo • 1 cassetto • sifone incl.  
Smusso 45° & soft-closing • vanity unit • 1 pull-out • siphon incl.  
Smusso 45° & fermetture amorte • meuble sous vasque • 1 tiroir • siphon incl.  
Smusso 45° • Waschtischunterschrank • 1 Soft-Closing Schublade • Siphon inkl.

L		F1	F2	F3
60	N3L06001			
70	N3L07001			
80	N3L08001			
90	N3L09001			
105	N3L10501			
120	N3L12001			

## P 51,5

L		F1	F2	F3
60	N3L06051			
70	N3L07051			
80	N3L08051			
90	N3L09051			
105	N3L10551			
120	N3L12051			

## H 25

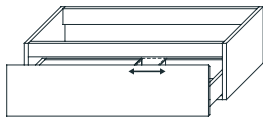

## P 45

Smusso 45° & chiusura ammortizzata • base portalavabo • 1 cassetto • scasso per sifone in posizione variabile  
Smusso 45° & soft-closing • vanity unit • 1 pull-out • cavity for siphon in variable position  
Smusso 45° & fermetture amorte • meuble sous vasque • 1 tiroir • trou pour le siphon en position variable  
Smusso 45° • Waschtischunterschrank • 1 Soft-Closing Schublade • Siphonousschnitt

L		F1	F2	F3
105	N3L10502			
120	N3L12002			

## P 51,5

L		F1	F2	F3
105	N3L10552			
120	N3L12052			

## H 25

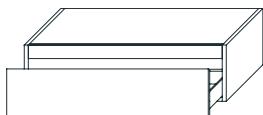

## P 45

Smusso 45° & chiusura ammortizzata • base laterale • 1 cassetto  
Smusso 45° & soft-closing • side unit • 1 pull-out  
Smusso 45° & fermetture amorte • meuble bas latéral • 1 tiroir  
Smusso 45° • Seitenschrank • 1 Soft-Closing Schublade

L		F1	F2	F3
30	N3B03001			
35	N3B03501			
45	N3B04501			
50	N3B05001			
60	N3B06001			
70	N3B07001			
90	N3B09001			
105	N3B10501			
120	N3B12001			

## P 51,5

L		F1	F2	F3
30	N3B03051			
35	N3B03551			
45	N3B04551			
50	N3B05051			
60	N3B06051			
70	N3B07051			
90	N3B09051			
105	N3B10551			
120	N3B12051			

 Misure in cm  
Measures in cm  
Mesures en cm  
Maße in cm

**F1** Laccato opaco  
Matt lacquered  
Laqué mat  
Matt lackiert

**F2** Laccato lucido  
Glossy lacquered  
Laqué brillant  
Hochglanz lackiert

**F3** Nobilitati  
Veneer wood  
Placage bois  
Beschichtetes Holz

**F4** Arock®  
Arock®  
Arock®  
Arock®

**F5** abitat / vogue  
abitat / vogue  
abitat / vogue  
abitat / vogue





## Basi Units

## Meubles bas Unterschränke

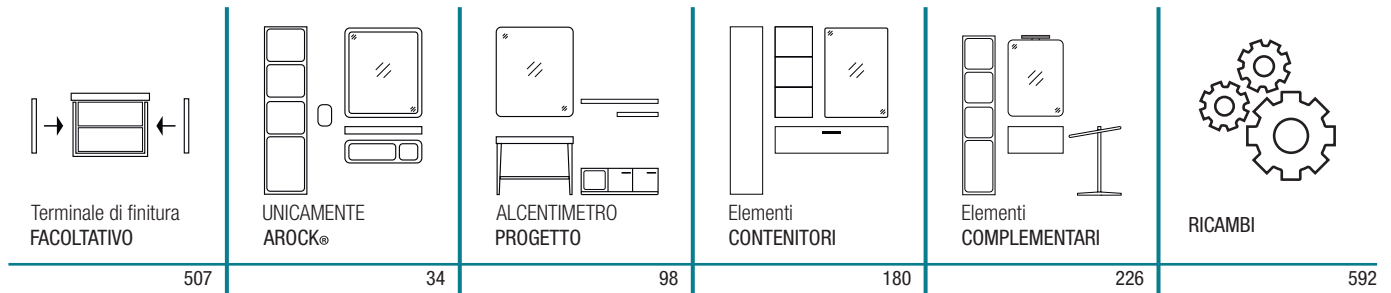

### H 25

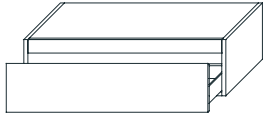

### P 45

Smusso 45° & chiusura ammortizzata • base laterale • 1 cassetto • scasso per sifone in posizione variabile  
Smusso 45° & soft-closing • side unit • 1 pull-out • cavity for siphon in variable position  
Smusso 45° & fermetture amorte • meuble bas latéral • 1 tiroir • trou pour le siphon en position variable  
Smusso 45° • Seitenschrank • 1 Soft-Closing Schublade • Siphonousschnitt

L		F1	F2	F3
105	N3B10502			
120	N3B12002			

### P 51,5

L		F1	F2	F3
105	N3B10552			
120	N3B12052			

### H 40

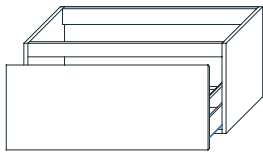

### P 45

Smusso 45° & chiusura ammortizzata • base portalavabo • 1 cassetto • sifone incl.  
Smusso 45° & soft-closing • vanity unit • 1 pull-out • siphon incl.  
Smusso 45° & fermetture amorte • meuble sous vasque • 1 tiroir • siphon incl.  
Smusso 45° • Waschtischunterschrank • 1 Soft-Closing Schublade • Siphon inkl.

L		F1	F2	F3
60	N3L06004			
70	N3L07004			
80	N3L08004			
90	N3L09004			
105	N3L10504			
120	N3L12004			

### P 51,5

L		F1	F2	F3
60	N3L06054			
70	N3L07054			
80	N3L08054			
90	N3L09054			
105	N3L10554			
120	N3L12054			

### H 40

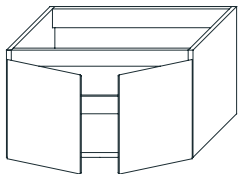

### P 45

Smusso 45° & chiusura ammortizzata • base portalavabo • 2 ante • sifone incl.  
Smusso 45° & soft-closing • vanity unit • 2 doors • siphon incl.  
Smusso 45° & fermetture amorte • meuble sous vasque • 2 portes • siphon incl.  
Smusso 45° • Waschtischunterschrank • 2 Türen • Siphon inkl.

L		F1	F2	F3
60	N3L06005			
70	N3L07005			
80	N3L08005			
90	N3L09005			

### P 51,5

L		F1	F2	F3
60	N3L06055			
70	N3L07055			
80	N3L08055			
90	N3L09055			



Misure in cm  
Measures in cm  
Mesures en cm  
Maße in cm

**F1** Laccato opaco  
Matt lacquered  
Laqué mat  
Matt lackiert

**F2** Laccato lucido  
Glossy lacquered  
Laqué brillant  
Hochglanz lackiert

**F3** Nobilitati  
Veneer wood  
Placage bois  
Beschichtetes Holz

**F4** Arock®  
Arock®  
Arock®  
Arock®

**F5** abitat / vogue  
abitat / vogue  
abitat / vogue  
abitat / vogue



## Basi Units

## Meubles bas Unterschränke

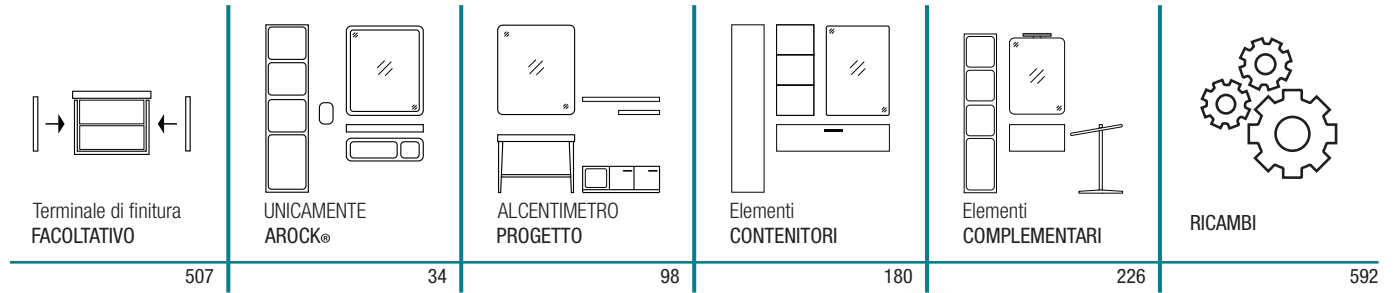

### H 40



### P 45

Smusso 45° & chiusura ammortizzata • base laterale • 1 cassetto  
Smusso 45° & soft-closing • side unit • 1 pull-out  
Smusso 45° & fermeture amortie • meuble bas latéral • 1 tiroir  
Smusso 45° • Seitenschrank • 1 Soft-Closing Schublade

L		F1	F2	F3
30	N3B03007			
35	N3B03507			
45	N3B04507			
50	N3B05007			
60	N3B06007			
70	N3B07007			
90	N3B09007			
105	N3B10507			
120	N3B12007			

### P 51,5

L		F1	F2	F3
30	N3B03057			
35	N3B03557			
45	N3B04557			
50	N3B05057			
60	N3B06057			
70	N3B07057			
90	N3B09057			
105	N3B10557			
120	N3B12057			

### H 40

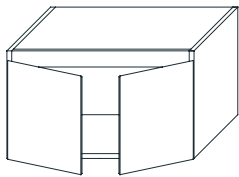

### P 45

Smusso 45° & chiusura ammortizzata • base laterale • 2 ante  
Smusso 45° & soft-closing • side unit • 2 doors  
Smusso 45° & fermeture amortie • meuble bas latéral • 2 portes  
Smusso 45° • Seitenschrank • 2 Türen

L		F1	F2	F3
50	N3B05010			
60	N3B06010			
70	N3B07010			
90	N3B09010			

### P 51,5

L		F1	F2	F3
50	N3B05060			
60	N3B06060			
70	N3B07060			
90	N3B09060			

### H 40

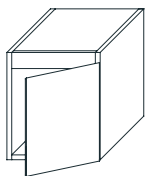

### P 45

Smusso 45° & chiusura ammortizzata • base laterale dx • 1 anta  
Smusso 45° & soft-closing • side unit • 1 door  
Smusso 45° & fermeture amortie • meuble bas latéral • 1 porte  
Smusso 45° • Seitenschrank • 1 Tür

L		F1	F2	F3
30	N3B03008			
35	N3B03508			
45	N3B04508			

### P 51,5

L		F1	F2	F3
30	N3B03058			
35	N3B03558			
45	N3B04558			

H  
L  
P

Misure in cm  
Measures in cm  
Mesures en cm  
Maße in cm

**F1** Laccato opaco  
Matt lacquered  
Laqué mat  
Matt lackiert

**F2** Laccato lucido  
Glossy lacquered  
Laqué brillant  
Hochglanz lackiert

**F3** Nobilitati  
Veneer wood  
Placage bois  
Beschichtetes Holz

**F4** Arock®  
Arock®  
Arock®  
Arock®

**F5** abitat / vogue  
abitat / vogue  
abitat / vogue  
abitat / vogue

# Basi Units

# Meubles bas Unterschränke

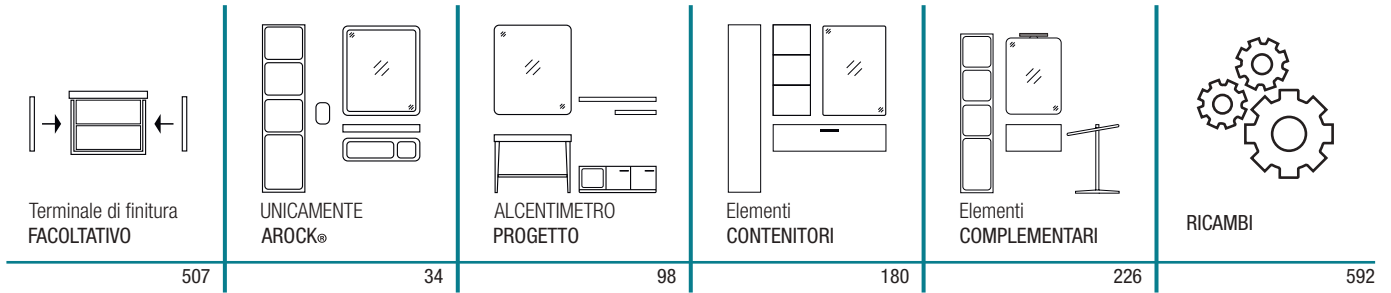

## H 40

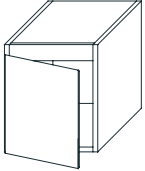

## P 45

Smusso 45° & chiusura ammortizzata • base laterale sx • 1 anta  
Smusso 45° & soft-closing • side unit • 1 door  
Smusso 45° & fermetture amorte • meuble bas latéral • 1 porte  
Smusso 45° • Seitenschrank • 1 Tür

L	F1	F2	F3
30	N3B03009		
35	N3B03509		
45	N3B04509		

## P 51,5

L	F1	F2	F3
30	N3B03059		
35	N3B03559		
45	N3B04559		

## H 50

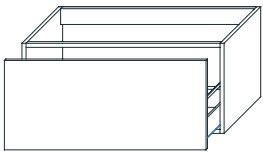

## P 45

Smusso 45° & chiusura ammortizzata • base portalavabo • 1 cassetto  
Smusso 45° & soft-closing • vanity unit • 1 pull out  
Smusso 45° & fermetture amorte • meuble sous vasque • 1 tiroir  
Smusso 45° • Waschtischunterschrank • 1 Soft-Closing Schublade

L	F1	F2	F3
60	N3L06019		
70	N3L07019		
80	N3L08019		
90	N3L09019		

## P 51,5

L	F1	F2	F3
60	N3L06069		
70	N3L07069		
80	N3L08069		
90	N3L09069		

## H 50

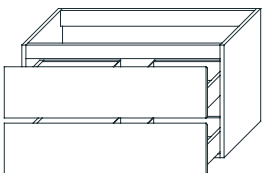

## P 45

Smusso 45° & chiusura ammortizzata • base portalavabo • 2 cassetti • sifone incl.  
Smusso 45° & soft-closing • vanity unit • 2 pull-out • siphon incl.  
Smusso 45° & fermetture amorte • meuble sous vasque • 2 tiroirs • siphon incl.  
Smusso 45° • Waschtischunterschrank • 2 Soft-Closing Schubladen • Siphon inkl.

L	F1	F2	F3
60	N3L06012		
70	N3L07012		
80	N3L08012		
90	N3L09012		
105	N3L10512		
120	N3L12012		

## P 51,5

L	F1	F2	F3
60	N3L06062		
70	N3L07062		
80	N3L08062		
90	N3L09062		
105	N3L10562		
120	N3L12062		



Misure in cm  
Measures in cm  
Mesures en cm  
Maße in cm

**F1** Laccato opaco  
Matt lacquered  
Laqué mat  
Matt lackiert

**F2** Laccato lucido  
Glossy lacquered  
Laqué brillant  
Hochglanz lackiert



**F3** Nobilitati  
Veneer wood  
Placage bois  
Beschichtetes Holz

**F4** Arock®  
Arock®  
Arock®  
Arock®

**F5** abitat / vogue  
abitat / vogue  
abitat / vogue  
abitat / vogue

# Basi Units

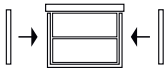
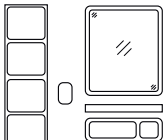
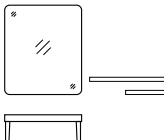
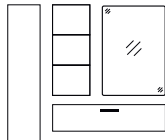
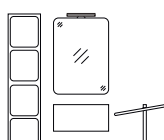
# Meubles bas Unterschränke

					
Terminale di finitura FACOLTATIVO	UNICAMENTE AROCK®	ALCENTIMETRO PROGETTO	Elementi CONTENITORI	Elementi COMPLEMENTARI	RICAMBI
507	34	98	180	226	592

**H 50**

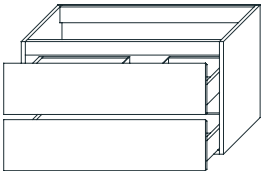

**P 45**

Smusso 45° & chiusura ammortizzata • base portalavabo • 2 cassetti • scasso per sifone dx  
 Smusso 45° & soft-closing • vanity unit • 2 pull-out • right cavity for siphon  
 Smusso 45° & fermetture amorte • meuble sous vasque • 2 tiroirs • trou droite pour le siphon  
 Smusso 45° • Waschtischunterschrank • 2 Soft-Closing Schubladen • Siphonousschnitt-rechts

<b>L</b>	<b>F1</b>	<b>F2</b>	<b>F3</b>
105 N3L10516			

**P 51,5**

<b>L</b>	<b>F1</b>	<b>F2</b>	<b>F3</b>
105 N3L10566			

**H 50**

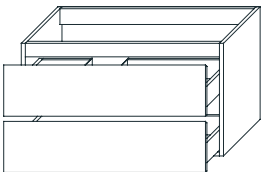

**P 45**

Smusso 45° & chiusura ammortizzata • base portalavabo • 2 cassetti • scasso per sifone dx  
 Smusso 45° & soft-closing • vanity unit • 2 pull-out • left cavity for siphon  
 Smusso 45° & fermetture amorte • meuble sous vasque • 2 tiroirs • trou gauche pour le siphon  
 Smusso 45° • Waschtischunterschrank • 2 Soft-Closing Schubladen • Siphonousschnitt-links

<b>L</b>	<b>F1</b>	<b>F2</b>	<b>F3</b>
105 N3L10517			

**P 51,5**

<b>L</b>	<b>F1</b>	<b>F2</b>	<b>F3</b>
105 N3L10567			

**H 50**

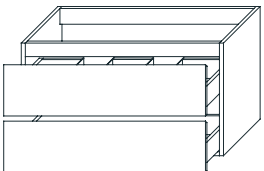

**P 45**

Smusso 45° & chiusura ammortizzata • base portalavabo • 2 cassetti • scasso per sifone doppio  
 Smusso 45° & soft-closing • vanity unit • 2 pull-out • double cavity for siphon  
 Smusso 45° & fermetture amorte • meuble sous vasque • 2 tiroirs • trou pour le siphon double  
 Smusso 45° • Waschtischunterschrank • 2 Soft-Closing Schubladen • Siphonousschnitt-doppelt

<b>L</b>	<b>F1</b>	<b>F2</b>	<b>F3</b>
120 N3L12011			

**P 51,5**

<b>L</b>	<b>F1</b>	<b>F2</b>	<b>F3</b>
120 N3L12061			

	Misure in cm	<b>F1</b> Laccato opaco	<b>F2</b> Laccato lucido	<b>F3</b> Nobilitati	<b>F4</b> Arock®	<b>F5</b> abitat / vogue
	Measures in cm	Matt lacquered	Glossy lacquered	Veneer wood	Arock®	abitat / vogue
	Mesures en cm	Laqué mat	Laqué brillant	Placage bois	Arock®	abitat / vogue
	Maße in cm	Matt lackiert	Hochglanz lackiert	Beschichtetes Holz	Arock®	abitat / vogue

# Basi Units

# Meubles bas Unterschränke

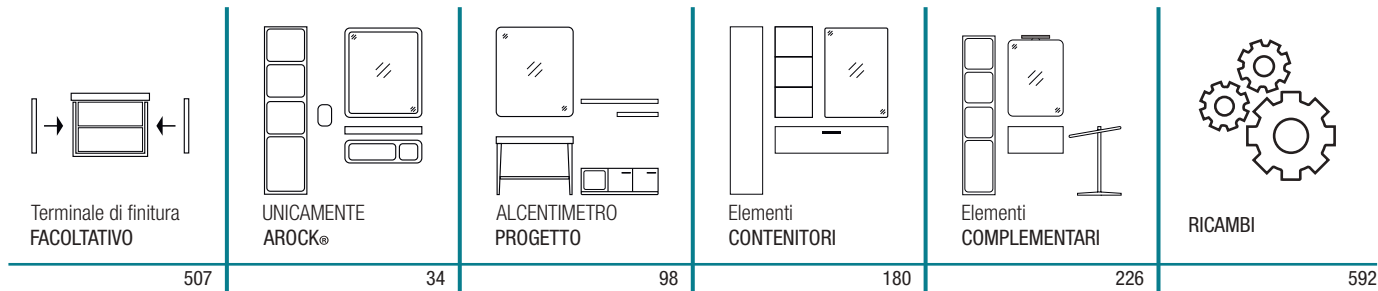

## H 50

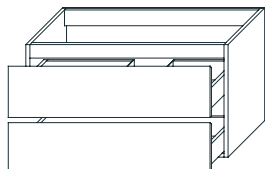

## P 45

Smusso 45° & chiusura ammortizzata • base portalavabo • 2 cassetti • scasso per sifone dx  
 Smusso 45° & soft-closing • vanity unit • 2 pull-out • right cavity for siphon  
 Smusso 45° & fermetture amorte • meuble sous vasque • 2 tiroirs • trou droite pour le siphon  
 Smusso 45° • Waschtischunterschrank • 2 Soft-Closing Schubladen • Siphonousschnitt-rechts

L	F1	F2	F3
120 N3L12014			

## P 51,5

L	F1	F2	F3
120 N3L12064			

## H 50

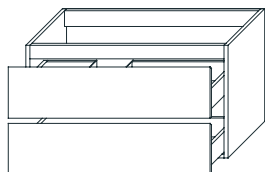

## P 45

Smusso 45° & chiusura ammortizzata • base portalavabo • 2 cassetti • scasso per sifone sx  
 Smusso 45° & soft-closing • vanity unit • 2 pull-out • left cavity for siphon  
 Smusso 45° & fermetture amorte • meuble sous vasque • 2 tiroirs • trou gauche pour le siphon  
 Smusso 45° • Waschtischunterschrank • 2 Soft-Closing Schubladen • Siphonousschnitt-links

L	F1	F2	F3
120 N3L12015			

## P 51,5

L	F1	F2	F3
120 N3L12065			

## H 50

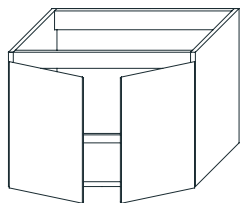

## P 45

Smusso 45° & chiusura ammortizzata • base portalavabo • 2 ante • sifone incl.  
 Smusso 45° & soft-closing • vanity unit • 2 doors • siphon incl.  
 Smusso 45° & fermetture amorte • meuble sous vasque • 2 portes • siphon incl.  
 Smusso 45° • Waschtischunterschrank • 2 Türen • Siphon inkl.

L	F1	F2	F3
60 N3L06013			
70 N3L07013			
80 N3L08013			
90 N3L09013			

## P 51,5

L	F1	F2	F3
60 N3L06063			
70 N3L07063			
80 N3L08063			
90 N3L09063			



Misure in cm  
 Measures in cm  
 Mesures en cm  
 Maße in cm

**F1** Laccato opaco  
 Matt lacquered  
 Laqué mat  
 Matt lackiert

**F2** Laccato lucido  
 Glossy lacquered  
 Laqué brillant  
 Hochglanz lackiert

**F3** Nobilitati  
 Veneer wood  
 Placage bois  
 Beschichtetes Holz

**F4** Arock®  
 Arock®  
 Arock®  
 Arock®

**F5** abitat / vogue  
 abitat / vogue  
 abitat / vogue  
 abitat / vogue

# Basi Units

# Meubles bas Unterschränke

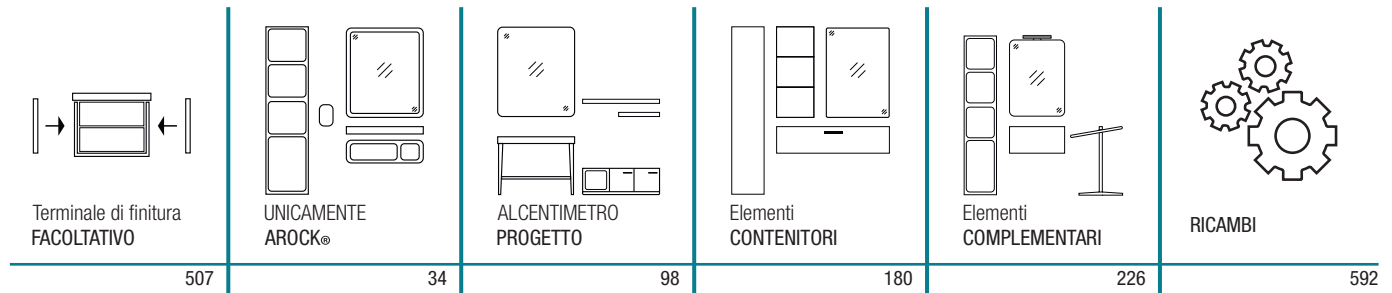

## H 50

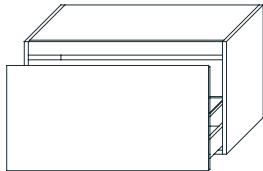

## P 45

Smusso 45° & chiusura ammortizzata • base laterale • 1 cassetto + 1 ripiano  
Smusso 45° & soft-closing • side unit • 1 pull-out + 1 shelf  
Smusso 45° & fermetture amorte • meuble bas latéral • 1 tiroir + 1 étagère  
Smusso 45° • Seitenschrank • 1 Soft-Closing Schublade + 1 Regal

L		F1	F2	F3
30	N3B03019			
35	N3B03519			
45	N3B04519			
50	N3B05019			
60	N3B06019			
70	N3B07019			
90	N3B09019			
105	N3B10519			
120	N3B12019			

## P 51,5

L		F1	F2	F3
30	N3B03069			
35	N3B03569			
45	N3B04569			
50	N3B05069			
60	N3B06069			
70	N3B07069			
90	N3B09069			
105	N3B10569			
120	N3B12069			

## H 50

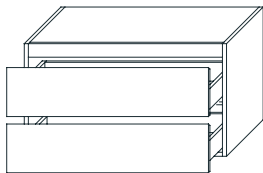

## P 45

Smusso 45° & chiusura ammortizzata • base laterale • 2 cassetti  
Smusso 45° & soft-closing • side unit • 2 pull-out  
Smusso 45° & fermetture amorte • meuble bas latéral • 2 tiroirs  
Smusso 45° • Seitenschrank • 2 Soft-Closing Schubladen

L		F1	F2	F3
30	N3B03012			
35	N3B03512			
45	N3B04512			
50	N3B05012			
60	N3B06012			
70	N3B07012			
90	N3B09012			
105	N3B10512			
120	N3B12012			

## P 51,5

L		F1	F2	F3
30	N3B03062			
35	N3B03562			
45	N3B04562			
50	N3B05062			
60	N3B06062			
70	N3B07062			
90	N3B09062			
105	N3B10562			
120	N3B12062			

## H 50

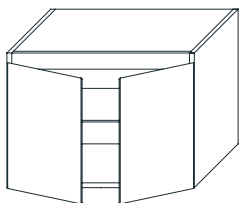

## P 45

Smusso 45° & chiusura ammortizzata • base laterale • 2 ante + 1 ripiano  
Smusso 45° & soft-closing • side unit • 2 doors + 1 shelf  
Smusso 45° & fermetture amorte • meuble bas latéral • 2 portes + 1 étagère  
Smusso 45° • Seitenschrank • 2 Türen + 1 Regal

L		F1	F2	F3
50	N3B05014			
60	N3B06014			
70	N3B07014			
90	N3B09014			

## P 51,5

L		F1	F2	F3
50	N3B05064			
60	N3B06064			
70	N3B07064			
90	N3B09064			

H  
L  
P

Misure in cm  
Measures in cm  
Mesures en cm  
Maße in cm

**F1** Laccato opaco  
Matt lacquered  
Laqué mat  
Matt lackiert

**F2** Laccato lucido  
Glossy lacquered  
Laqué brillant  
Hochglanz lackiert

**F3** Nobilitati  
Veneer wood  
Placage bois  
Beschichtetes Holz

**F4** Arock®  
Arock®  
Arock®  
Arock®

**F5** abitat / vogue  
abitat / vogue  
abitat / vogue  
abitat / vogue

## Basi Units

## Meubles bas Unterschränke

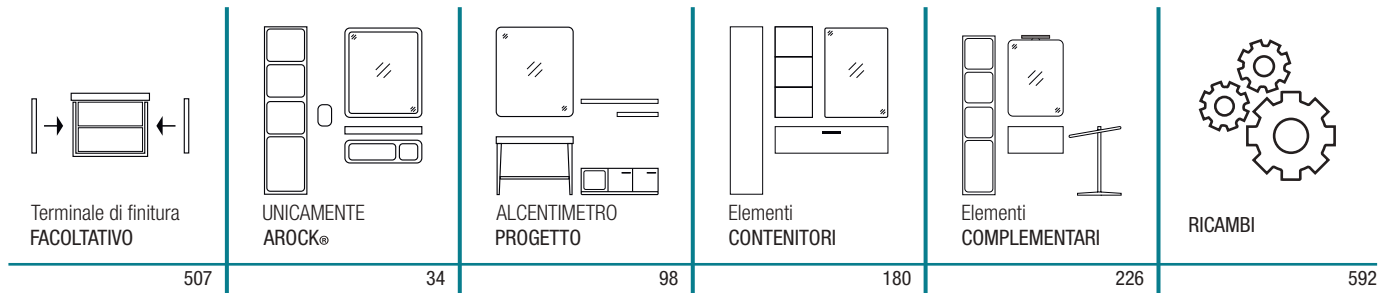

### H 50

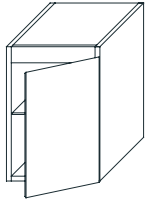

### P 45

Smusso 45° & chiusura ammortizzata • base laterale dx • 1 anta + 1 ripiano  
Smusso 45° & soft-closing • side unit • 1 door + 1 shelf  
Smusso 45° & fermetture amorte • meuble bas latéral • 1 porte + 1 étagère  
Smusso 45° • Seitenschrank • 1 Tür + 1 Regal

L		F1	F2	F3
30	N3B03016			
35	N3B03516			
45	N3B04516			

### P 51,5

L		F1	F2	F3
30	N3B03066			
35	N3B03566			
45	N3B04566			

### H 50

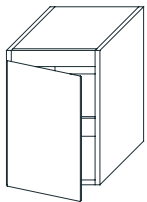

### P 45

Smusso 45° & chiusura ammortizzata • base laterale sx • 1 anta + 1 ripiano  
Smusso 45° & soft-closing • side unit • 1 door + 1 shelf  
Smusso 45° & fermetture amorte • meuble bas latéral • 1 porte + 1 étagère  
Smusso 45° • Seitenschrank • 1 Tür + 1 Regal

L		F1	F2	F3
30	N3B03017			
35	N3B03517			
45	N3B04517			

### P 51,5

L		F1	F2	F3
30	N3B03067			
35	N3B03567			
45	N3B04567			

### H 75

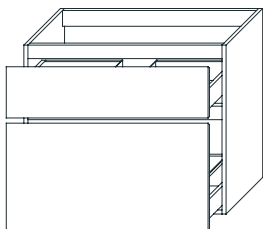

### P 45

Smusso 45° & chiusura ammortizzata • base portalavabo • 2 cassetti • sifone incl.  
Smusso 45° & soft-closing • vanity unit • 2 pull-out • siphon incl.  
Smusso 45° & fermetture amorte • meuble sous vasque • 2 tiroirs • siphon incl.  
Smusso 45° • Waschtischunterschrank • 2 Soft-Closing Schubladen • Siphon inkl.

L		F1	F2	F3
60	N3L06022			
70	N3L07022			
80	N3L08022			
90	N3L09022			
105	N3L10522			
120	N3L12022			

### P 51,5

L		F1	F2	F3
60	N3L06072			
70	N3L07072			
80	N3L08072			
90	N3L09072			
105	N3L10572			
120	N3L12072			



Misure in cm  
Measures in cm  
Mesures en cm  
Maße in cm

**F1** Laccato opaco  
Matt lacquered  
Laqué mat  
Matt lackiert

**F2** Laccato lucido  
Glossy lacquered  
Laqué brillant  
Hochglanz lackiert

**F3** Nobilitati  
Veneer wood  
Placage bois  
Beschichtetes Holz

**F4** Arock®  
Arock®  
Arock®  
Arock®

**F5** abitat / vogue  
abitat / vogue  
abitat / vogue  
abitat / vogue

## Basi Units

## Meubles bas Unterschränke

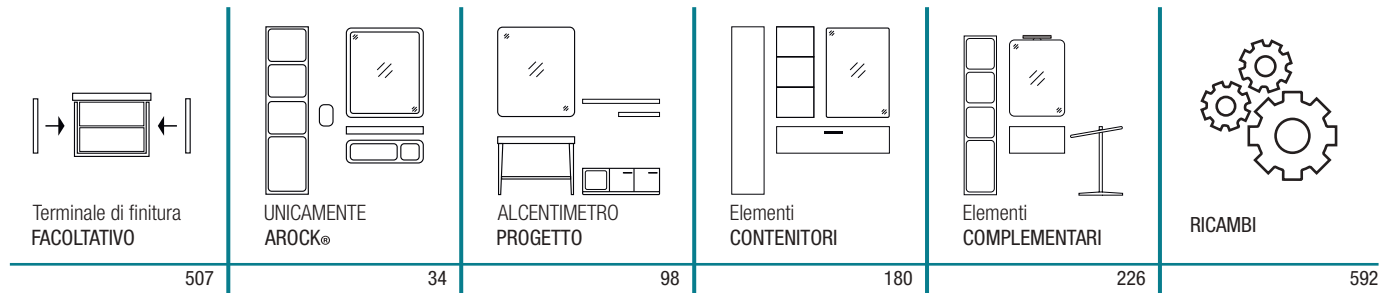

### H 75

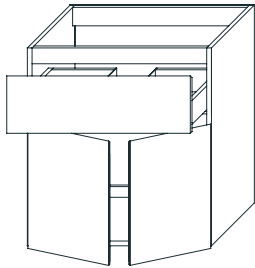

### P 45

Smusso 45° & chiusura ammortizzata • base portalavabo • 1 cassetto + 2 ante • sifone incl.  
 Smusso 45° & soft-closing • vanity unit • 1 pull-out + 2 doors • siphon incl.  
 Smusso 45° & fermeture amortie • meuble sous vasque • 1 tiroir + 2 portes • siphon incl.  
 Smusso 45° • Waschtischunterschrank • 1 Soft-Closing Schublade + 2 Türen • Siphon inkl.

L		F1	F2	F3
60	N3L06023			
70	N3L07023			
80	N3L08023			
90	N3L09023			

### P 51,5

L		F1	F2	F3
60	N3L06073			
70	N3L07073			
80	N3L08073			
90	N3L09073			

### H 75

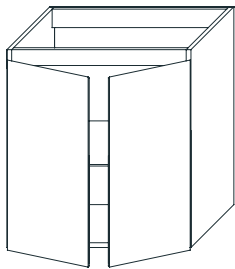

### P 45

Smusso 45° & chiusura ammortizzata • base portalavabo • 2 ante + 1 ripiano • sifone incl.  
 Smusso 45° & soft-closing • vanity unit • 2 doors + 1 shelf • siphon incl.  
 Smusso 45° & fermeture amortie • meuble sous vasque • 2 portes + 1 étagère • siphon incl.  
 Smusso 45° • Waschtischunterschrank • 2 Türen + 1 Regal • Siphon inkl.

L		F1	F2	F3
60	N3L06024			
70	N3L07024			
80	N3L08024			
90	N3L09024			

### P 51,5

L		F1	F2	F3
60	N3L06074			
70	N3L07074			
80	N3L08074			
90	N3L09074			

### H 75

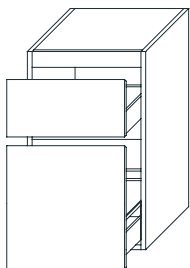

### P 45

Smusso 45° & chiusura ammortizzata • base laterale • 2 cassetti + 1 ripiano  
 Smusso 45° & soft-closing • side unit • 2 pull-out + 1 shelf  
 Smusso 45° & fermeture amortie • meuble bas latéral • 2 tiroirs + 1 étagère  
 Smusso 45° • Seitenschrank • 2 Soft-Closing Schubladen + 1 Regal

L		F1	F2	F3
30	N3B03025			
35	N3B03525			
45	N3B04525			
50	N3B05025			
60	N3B06025			

### P 51,5

L		F1	F2	F3
30	N3B03075			
35	N3B03575			
45	N3B04575			
50	N3B05075			
60	N3B06075			

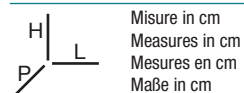

**F1** Laccato opaco  
Matt lacquered  
Laqué mat  
Matt lackiert

**F2** Laccato lucido  
Glossy lacquered  
Laqué brillant  
Hochglanz lackiert

**F3** Nobilitati  
Veneer wood  
Placage bois  
Beschichtetes Holz

**F4** Arock®  
Arock®  
Arock®  
Arock®

**F5** abitat / vogue  
abibat / vogue  
abibat / vogue  
abibat / vogue

# Basi Units

# Meubles bas Unterschränke

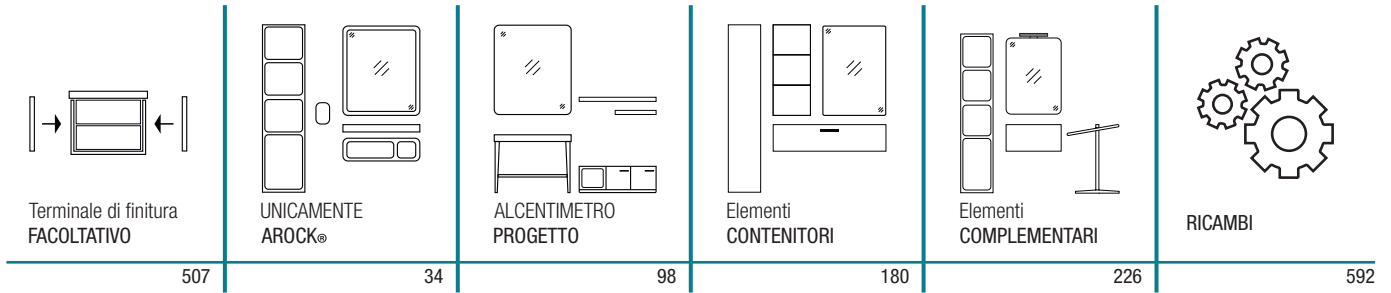

## H 75

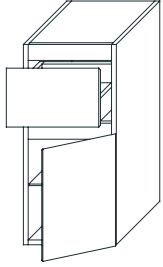

## P 45

Smusso 45° & chiusura ammortizzata • base laterale dx • 1 cassetto + 1 anta + 1 ripiano  
 Smusso 45° & soft-closing • side unit • 1 pull-out + 1 door + 1 shelf  
 Smusso 45° & fermetture amorte • meuble bas latéral • 1 tiroir + 1 porte + 1 étagère  
 Smusso 45° • Seitenschrank • 1 Soft-Closing Schublade + 1 Tür + 1 Regal

L		F1	F2	F3
30	N3B03026			
35	N3B03526			
45	N3B04526			

## P 51,5

L		F1	F2	F3
30	N3B03076			
35	N3B03576			
45	N3B04576			

## H 75

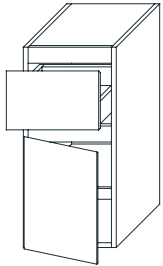

## P 45

Smusso 45° & chiusura ammortizzata • base laterale sx • 1 cassetto + 1 anta + 1 ripiano  
 Smusso 45° & soft-closing • side unit • 1 pull-out + 1 door + 1 shelf  
 Smusso 45° & fermetture amorte • meuble bas latéral • 1 tiroir + 1 porte + 1 étagère  
 Smusso 45° • Seitenschrank • 1 Soft-Closing Schublade + 1 Tür + 1 Regal

L		F1	F2	F3
30	N3B03027			
35	N3B03527			
45	N3B04527			

## P 51,5

L		F1	F2	F3
30	N3B03077			
35	N3B03577			
45	N3B04577			

## H 75

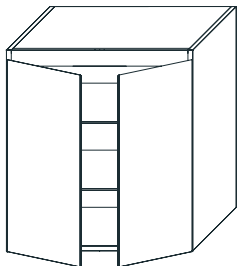

## P 45

Smusso 45° & chiusura ammortizzata • base laterale • 2 ante + 2 ripiani  
 Smusso 45° & soft-closing • side unit • 2 doors + 2 shelves  
 Smusso 45° & fermetture amorte • meuble bas latéral • 2 portes + 2 étagères  
 Smusso 45° • Seitenschrank • 2 Türen + 2 Regale

L		F1	F2	F3
50	N3B05029			
60	N3B06029			
70	N3B07029			
90	N3B09029			

## P 51,5

L		F1	F2	F3
50	N3B05079			
60	N3B06079			
70	N3B07079			
90	N3B09079			

H  
L  
P

Misure in cm  
Measures in cm  
Mesures en cm  
Maße in cm

**F1** Laccato opaco  
Matt lacquered  
Laqué mat  
Matt lackiert

**F2** Laccato lucido  
Glossy lacquered  
Laqué brillant  
Hochglanz lackiert

**F3** Nobilitati  
Veneer wood  
Placage bois  
Beschichtetes Holz

**F4** Arock®  
Arock®  
Arock®  
Arock®

**F5** abitat / vogue  
abitat / vogue  
abitat / vogue  
abitat / vogue



## Basi Units

## Meubles bas Unterschränke

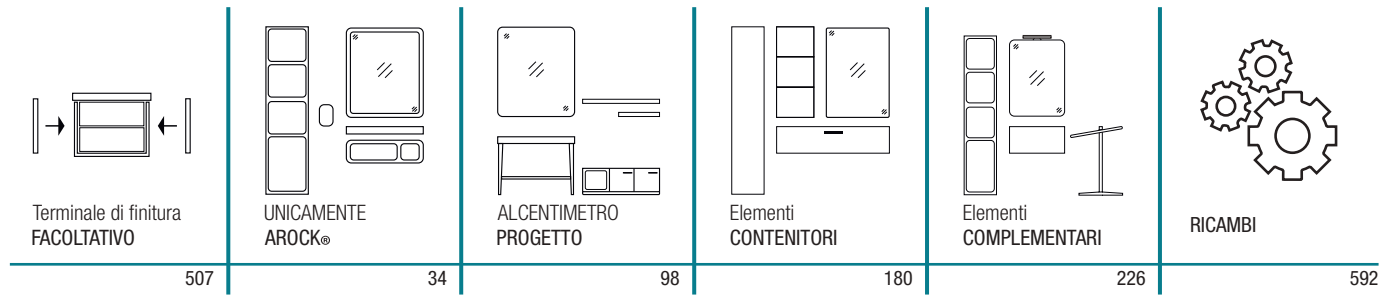

### H 75

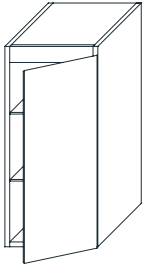

### P 45

Smusso 45° & chiusura ammortizzata • base laterale dx • 1 anta + 2 ripiani  
 Smusso 45° & soft-closing • side unit • 1 door + 2 shelves  
 Smusso 45° & fermeture amortie • meuble bas latéral • 1 porte + 2 étagères  
 Smusso 45° • Seitenschrank • 1 Tür + 2 Regale

L		F1	F2	F3
30	N3B03030			
35	N3B03530			
45	N3B04530			

### P 51,5

L		F1	F2	F3
30	N3B03080			
35	N3B03580			
45	N3B04580			

### H 75

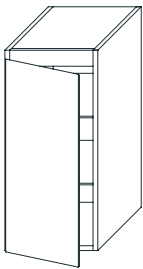

### P 45

Smusso 45° & chiusura ammortizzata • base laterale sx • 1 anta + 2 ripiani  
 Smusso 45° & soft-closing • side unit • 1 door + 2 shelves  
 Smusso 45° & fermeture amortie • meuble bas latéral • 1 porte + 2 étagères  
 Smusso 45° • Seitenschrank • 1 Tür + 2 Regale

L		F1	F2	F3
30	N3B03031			
35	N3B03531			
45	N3B04531			

### P 51,5

L		F1	F2	F3
30	N3B03081			
35	N3B03581			
45	N3B04581			

### H 87

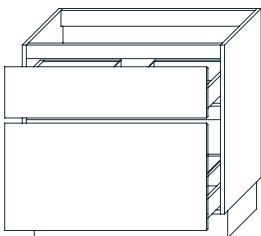

### P 45

Smusso 45° & chiusura ammortizzata • base portalavabo • 2 cassetti • zoccolo H 12 + sifone incl.  
 Smusso 45° & soft-closing • vanity unit • 2 pull-out • toe-kick H 12 + siphon incl.  
 Smusso 45° & fermeture amortie • meuble sous vasque • 2 tiroirs • socle H 12 + siphon incl.  
 Smusso 45° • Waschtischunterschrank • 2 Soft-Closing Schubladen • Sockel H 12 + Siphon inkl.

L		F1	F2	F3
60	N3L06034			
70	N3L07034			
80	N3L08034			
90	N3L09034			
105	N3L10534			
120	N3L12034			

### P 51,5

L		F1	F2	F3
60	N3L06084			
70	N3L07084			
80	N3L08084			
90	N3L09084			
105	N3L10584			
120	N3L12084			

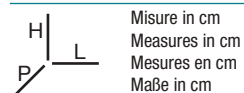

Misure in cm  
 Measures in cm  
 Mesures en cm  
 Maße in cm

**F1** Laccato opaco  
 Matt lacquered  
 Laqué mat  
 Matt lackiert

**F2** Laccato lucido  
 Glossy lacquered  
 Laqué brillant  
 Hochglanz lackiert

**F3** Nobilitati  
 Veneer wood  
 Placage bois  
 Beschichtetes Holz

**F4** Arock®  
 Arock®  
 Arock®  
 Arock®

**F5** abitat / vogue  
 abitat / vogue  
 abitat / vogue  
 abitat / vogue

# Basi Units

# Meubles bas Unterschränke

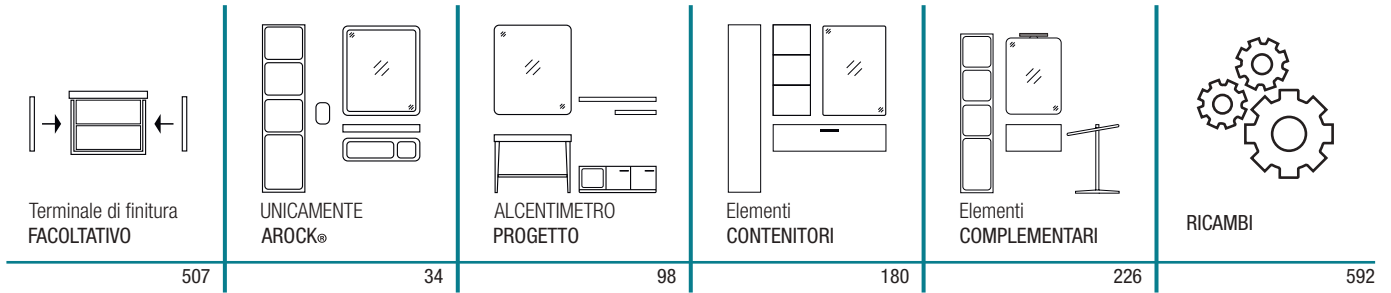

## H 87

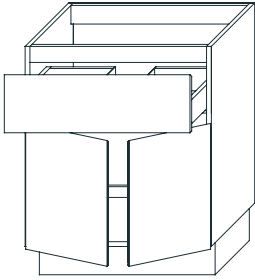

## P 45

Smusso 45° & chiusura ammortizzata • base portalavabo • 1 cassetto + 2 ante • zoccolo H 12 + sifone incl.  
Smusso 45° & soft-closing • vanity unit • 1 pull-out + 2 doors • toe-kick H 12 + siphon incl.  
Smusso 45° & fermetture amorte • meuble sous vasque • 1 tiroir + 2 portes • socle H 12 + siphon incl.  
Smusso 45° • Waschtischunterschrank • 1 Soft-Closing Schublade + 2 Türen • Sockel H 12 + Siphon inkl.

L		F1	F2	F3
60	N3L06035			
70	N3L07035			
80	N3L08035			
90	N3L09035			

## P 51,5

L		F1	F2	F3
60	N3L06085	515		
70	N3L07085	560		
80	N3L08085	580		
90	N3L09085	590		

## H 87

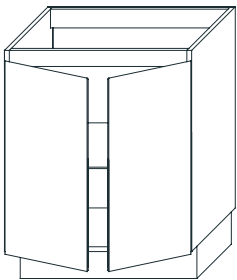

## P 45

Smusso 45° & chiusura ammortizzata • base portalavabo • 2 ante + 1 ripiano • zoccolo H 12 + sifone incl.  
Smusso 45° & soft-closing • vanity unit • 2 doors + 1 shelf • toe-kick H 12 + siphon incl.  
Smusso 45° & fermetture amorte • meuble sous vasque • 2 portes + 1 étagère • socle H 12 + siphon incl.  
Smusso 45° • Waschtischunterschrank • 2 Türen + 1 Regal • Sockel H 12 + Siphon inkl.

L		F1	F2	F3
60	N3L06036			
70	N3L07036			
80	N3L08036			
90	N3L09036			

## P 51,5

L		F1	F2	F3
60	N3L06086			
70	N3L07086			
80	N3L08086			
90	N3L09086			

## H 87

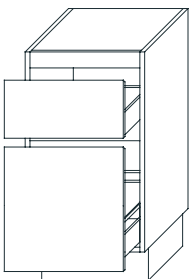

## P 45

Smusso 45° & chiusura ammortizzata • base laterale • 2 cassetti + 1 ripiano • zoccolo H 12 incl.  
Smusso 45° & soft-closing • side unit • 2 pull-out + 1 shelf • toe-kick H 12 incl.  
Smusso 45° & fermetture amorte • meuble bas latéral • 2 tiroirs + 1 étagère • socle H 12 incl.  
Smusso 45° • Seitenschrank • 2 Soft-Closing Schubladen + 1 Regal • Sockel H 12 inkl.

L		F1	F2	F3
30	N3B03037			
35	N3B03537			
45	N3B04537			
50	N3B05037			
60	N3B06037			

## P 51,5

L		F1	F2	F3
30	N3B03087			
35	N3B03587			
45	N3B04587			
50	N3B05087			
60	N3B06087			



Misure in cm  
Measures in cm  
Mesures en cm  
Maße in cm

**F1** Laccato opaco  
Matt lacquered  
Laqué mat  
Matt lackiert

**F2** Laccato lucido  
Glossy lacquered  
Laqué brillant  
Hochglanz lackiert



**F3** Nobilitati  
Veneer wood  
Placage bois  
Beschichtetes Holz

**F4** Arock®  
Arock®  
Arock®  
Arock®

**F5** abitat / vogue  
abitat / vogue  
abitat / vogue  
abitat / vogue

## Basi Units

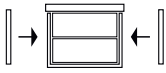
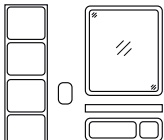
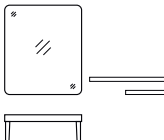
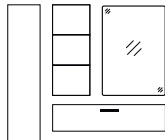
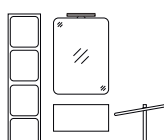
## Meubles bas Unterschränke

					
Terminale di finitura FACOLTATIVO	UNICAMENTE AROCK®	ALCENTIMETRO PROGETTO	Elementi CONTENITORI	Elementi COMPLEMENTARI	RICAMBI
507	34	98	180	226	592

### H 87

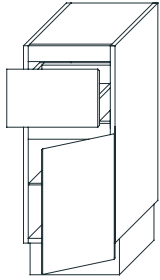

### P 45

Smusso 45° & chiusura ammortizzata • base laterale dx • 1 cassetto + 1 anta + 1 ripiano • zoccolo H 12 incl.  
 Smusso 45° & soft-closing • side unit • 1 pull-out + 1 door + 1 shelf • toe-kick H 12 incl.  
 Smusso 45° & fermetture amorte • meuble bas latéral • 1 tiroir + 1 porte + 1 étagère • socle H 12 incl.  
 Smusso 45° • Seitenschrank • 1 Soft-Closing Schublade + 1 Tür + 1 Regal • Sockel H 12 inkl.

L		F1	F2	F3
30	N3B03038			
35	N3B03538			
45	N3B04538			

### P 51,5

L		F1	F2	F3
30	N3B03088			
35	N3B03588			
45	N3B04588			

### H 87

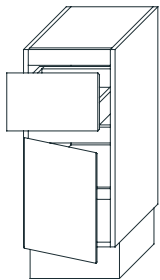

### P 45

Smusso 45° & chiusura ammortizzata • base laterale sx • 1 cassetto + 1 anta + 1 ripiano • zoccolo H 12 incl.  
 Smusso 45° & soft-closing • side unit • 1 pull-out + 1 door + 1 shelf • toe-kick H 12 incl.  
 Smusso 45° & fermetture amorte • meuble bas latéral • 1 tiroir + 1 porte + 1 étagère • socle H 12 incl.  
 Smusso 45° • Seitenschrank • 1 Soft-Closing Schublade + 1 Tür + 1 Regal • Sockel H 12 inkl.

L		F1	F2	F3
30	N3B03039			
35	N3B03539			
45	N3B04539			

### P 51,5

L		F1	F2	F3
30	N3B03089			
35	N3B03589			
45	N3B04589			

### H 87

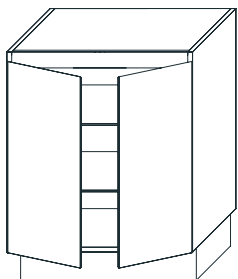

### P 45

Smusso 45° & chiusura ammortizzata • base laterale • 2 ante + 2 ripiani • zoccolo H 12 incl.  
 Smusso 45° & soft-closing • side unit • 2 doors + 2 shelves • toe-kick H 12 incl.  
 Smusso 45° & fermetture amorte • meuble bas latéral • 2 portes + 2 étagères • socle H 12 incl.  
 Smusso 45° • Seitenschrank • 2 Türen + 2 Regale • Sockel H 12 inkl.

L		F1	F2	F3
50	N3B05041			
60	N3B06041			
70	N3B07041			
90	N3B09041			

### P 51,5

L		F1	F2	F3
50	N3B05091			
60	N3B06091			
70	N3B07091			
90	N3B09091			

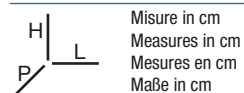

Misure in cm  
 Measures in cm  
 Mesures en cm  
 Maße in cm

**F1** Laccato opaco  
 Matt lacquered  
 Laqué mat  
 Matt lackiert

**F2** Laccato lucido  
 Glossy lacquered  
 Laqué brillant  
 Hochglanz lackiert

**F3** Nobilitati  
 Veneer wood  
 Placage bois  
 Beschichtetes Holz

**F4** Arock®  
 Arock®  
 Arock®  
 Arock®

**F5** abitat / vogue  
 abitat / vogue  
 abitat / vogue  
 abitat / vogue

## Basi Units

## Meubles bas Unterschränke

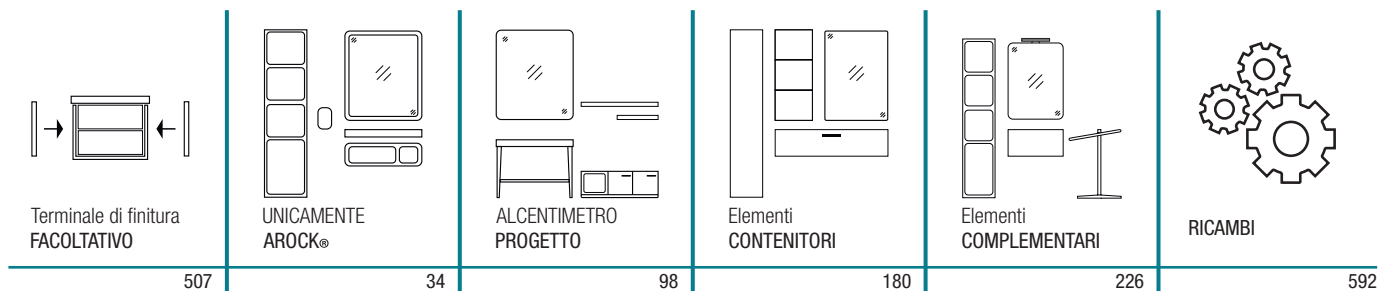

### H 87

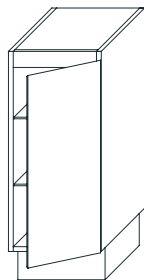

### P 45

Smusso 45° & chiusura ammortizzata • base laterale dx • 1 anta + 2 ripiani • zoccolo H 12 incl.  
 Smusso 45° & soft-closing • side unit • 1 door + 2 shelves • toe-kick H 12 incl.  
 Smusso 45° & fermeture amortie • meuble bas latéral • 1 porte + 2 étagères • socle H 12 incl.  
 Smusso 45° • Seitenschrank • 1 Tür + 2 Regale • Sockel H 12 inkl.

L		F1	F2	F3
30	N3B03042			
35	N3B03542			
45	N3B04542			

### P 51,5

L		F1	F2	F3
30	N3B03092			
35	N3B03592			
45	N3B04592			

### H 87

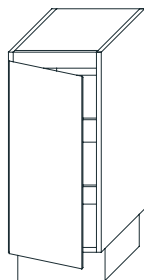

### P 45

Smusso 45° & chiusura ammortizzata • base laterale sx • 1 anta + 2 ripiani • zoccolo H 12 incl.  
 Smusso 45° & soft-closing • side unit • 1 door + 2 shelves • toe-kick H 12 incl.  
 Smusso 45° & fermetures amortie • meuble bas latéral • 1 porte + 2 étagères • socle H 12 incl.  
 Smusso 45° • Seitenschrank • 1 Tür + 2 Regale • Sockel H 12 inkl.

L		F1	F2	F3
30	N3B03043			
35	N3B03543			
45	N3B04543			

### P 51,5

L		F1	F2	F3
30	N3B03093			
35	N3B03593			
45	N3B04593			

H |  
 L |  
 P /

Misure in cm  
 Measures in cm  
 Mesures en cm  
 Maße in cm

**F1** Laccato opaco  
 Matt lacquered  
 Laqué mat  
 Matt lackiert

**F2** Laccato lucido  
 Glossy lacquered  
 Laqué brillant  
 Hochglanz lackiert



**F3** Nobilitati  
 Veneer wood  
 Placage bois  
 Beschichtetes Holz

**F4** Arock®  
 Arock®  
 Arock®  
 Arock®

**F5** abitat / vogue  
 abitat / vogue  
 abitat / vogue  
 abitat / vogue

# Basi Units

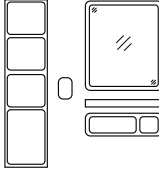
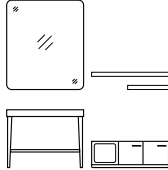
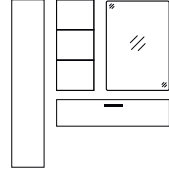
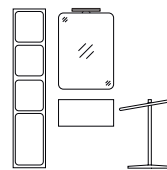
# Meubles bas Unterschränke

				
UNICAMENTE AROCK®	ALCENTIMETRO PROGETTO	Elementi CONTENITORI	Elementi COMPLEMENTARI	RICAMBI
34	98	180	226	592

## H 25

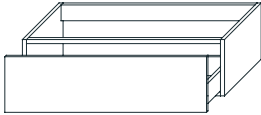

## P 45

Sistema Premi-Apri • base portalavabo • 1 cassetto • sifone incl.  
Premi-Apri System • vanity unit • 1 pull-out • siphon incl.  
Système Premi-Apri • meuble sous vasque • 1 tiroir • siphon incl.  
Premi-Apri System • Waschtischunterschrank • 1 Schublade • Siphon inkl.

L		F1	F2	F3
60	N1L06001			
70	N1L07001			
80	N1L08001			
90	N1L09001			
105	N1L10501			
120	N1L12001			

## P 51,5

L		F1	F2	F3
60	N1L06051			
70	N1L07051			
80	N1L08051			
90	N1L09051			
105	N1L10551			
120	N1L12051			

## H 25

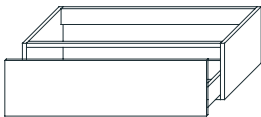

## P 45

Sistema Premi-Apri • base portalavabo • 1 cassetto • scasso per sifone in posizione variabile  
Premi-Apri System • vanity unit • 1 pull-out • cavity for siphon in variable position  
Système Premi-Apri • meuble sous vasque • 1 tiroir • trou pour le siphon en position variable  
Premi-Apri System • Waschtischunterschrank • 1 Schublade • Siphonousschnitt

L		F1	F2	F3
105	N1L10502			
120	N1L12002			

## P 51,5

L		F1	F2	F3
105	N1L10552			
120	N1L12052			

## H 25

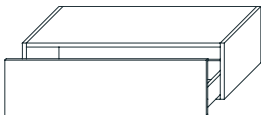

## P 45

Sistema Premi-Apri • base laterale • 1 cassetto  
Premi-Apri System • side unit • 1 pull-out  
Système Premi-Apri • meuble bas latéral • 1 tiroir  
Premi-Apri System • Seitenschrank • 1 Schublade

L		F1	F2	F3
30	N1B03001			
35	N1B03501			
45	N1B04501			
50	N1B05001			
60	N1B06001			
70	N1B07001			
90	N1B09001			
105	N1B10501			
120	N1B12001			

## P 51,5

L		F1	F2	F3
30	N1B03051			
35	N1B03551			
45	N1B04551			
50	N1B05051			
60	N1B06051			
70	N1B07051			
90	N1B09051			
105	N1B10551			
120	N1B12051			

 Misure in cm  
 Measures in cm  
 Mesures en cm  
 Maße in cm

**F1** Laccato opaco  
 Matt lacquered  
 Laqué mat  
 Matt lackiert

**F2** Laccato lucido  
 Glossy lacquered  
 Laqué brillant  
 Hochglanz lackiert

**F3** Nobilitati  
 Veneer wood  
 Placage bois  
 Beschichtetes Holz

**F4** Arock®  
 Arock®  
 Arock®  
 Arock®

**F5** abitat / vogue  
 abitat / vogue  
 abitat / vogue  
 abitat / vogue





# Basi Units

# Meubles bas Unterschränke

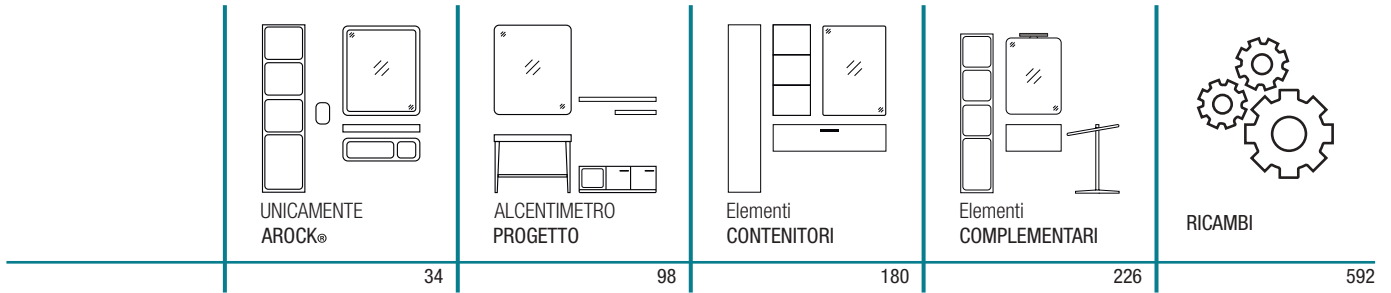

## H 25

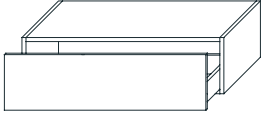

## P 45

Sistema Premi-Apri • base laterale • 1 cassetto • scasso per sifone in posizione variabile  
 Premi-Apri System • side unit • 1 pull-out • cavity for siphon in variable position  
 Système Premi-Apri • meuble bas latéral • 1 tiroir • trou pour le siphon en position variable  
 Premi-Apri System • Seitenschrank • 1 Schublade • Siphonousschnitt

L		F1	F2	F3
105	N1B10502			
120	N1B12002			

## P 51,5

L		F1	F2	F3
105	N1B10552			
120	N1B12052			

## H 40

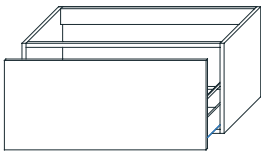

## P 45

Sistema Premi-Apri • base portlavabo • 1 cassetto • sifone incl.  
 Premi-Apri System • vanity unit • 1 pull-out • siphon incl.  
 Système Premi-Apri • meuble sous vasque • 1 tiroir • siphon incl.  
 Premi-Apri System • Waschtischunterschrank • 1 Schublade • Siphon inkl.

L		F1	F2	F3
60	N1L06004			
70	N1L07004			
80	N1L08004			
90	N1L09004			
105	N1L10504			
120	N1L12004			

## P 51,5

L		F1	F2	F3
60	N1L06054			
70	N1L07054			
80	N1L08054			
90	N1L09054			
105	N1L10554			
120	N1L12054			

## H 40

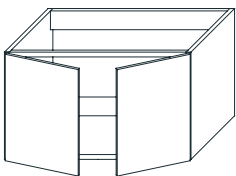

## P 45

Sistema Premi-Apri • base portlavabo • 2 ante • sifone incl.  
 Premi-Apri System • vanity unit • 2 doors • siphon incl.  
 Système Premi-Apri • meuble sous vasque • 2 portes • siphon incl.  
 Premi-Apri System • Waschtischunterschrank • 2 Türen • Siphon inkl.

L		F1	F2	F3
60	N1L06005			
70	N1L07005			
80	N1L08005			
90	N1L09005			

## P 51,5

L		F1	F2	F3
60	N1L06055			
70	N1L07055			
80	N1L08055			
90	N1L09055			



Misure in cm  
 Measures in cm  
 Mesures en cm  
 Maße in cm

**F1** Laccato opaco  
 Matt lacquered  
 Laqué mat  
 Matt lackiert

**F2** Laccato lucido  
 Glossy lacquered  
 Laqué brillant  
 Hochglanz lackiert

**F3** Nobilitati  
 Veneer wood  
 Placage bois  
 Beschichtetes Holz

**F4** Arock®  
 Arock®  
 Arock®  
 Arock®

**F5** abitat / vogue  
 abitat / vogue  
 abitat / vogue  
 abitat / vogue



# Basi Units

# Meubles bas Unterschränke

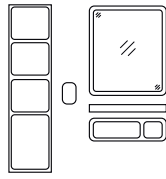

UNICAMENTE  
AROCK®

34

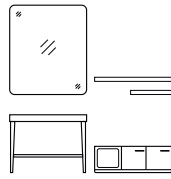

ALCENTIMETRO  
PROGETTO

98

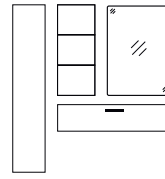

Elementi  
CONTENITORI

180

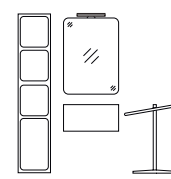

Elementi  
COMPLEMENTARI

226



RICAMBI

592

## H 40

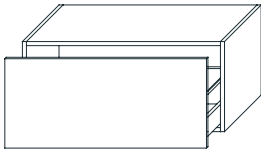

## P 45

Sistema Premi-Apri • base laterale • 1 cassetto  
Premi-Apri System • side unit • 1 pull-out  
Système Premi-Apri • meuble bas latéral • 1 tiroir  
Premi-Apri System • Seitenschrank • 1 Schublade

L		F1	F2	F3
30	N1B03007			
35	N1B03507			
45	N1B04507			
50	N1B05007			
60	N1B06007			
70	N1B07007			
90	N1B09007			
105	N1B10507			
120	N1B12007			

## P 51,5

L		F1	F2	F3
30	N1B03057			
35	N1B03557			
45	N1B04557			
50	N1B05057			
60	N1B06057			
70	N1B07057			
90	N1B09057			
105	N1B10557			
120	N1B12057			

## H 40

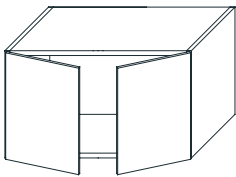

## P 45

Sistema Premi-Apri • base laterale • 2 ante  
Premi-Apri System • side unit • 2 doors  
Système Premi-Apri • meuble bas latéral • 2 portes  
Premi-Apri System • Seitenschrank • 2 Türen

L		F1	F2	F3
50	N1B05010			
60	N1B06010			
70	N1B07010			
90	N1B09010			

## P 51,5

L		F1	F2	F3
50	N1B05060			
60	N1B06060			
70	N1B07060			
90	N1B09060			

## H 40

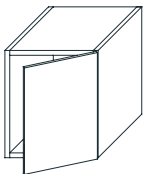

## P 45

Sistema Premi-Apri • base laterale dx • 1 anta  
Premi-Apri System • side unit • 1 door  
Système Premi-Apri • meuble bas latéral • 1 porte  
Premi-Apri System • Seitenschrank • 1 Tür

L		F1	F2	F3
30	N1B03008			
35	N1B03508			
45	N1B04508			

## P 51,5

L		F1	F2	F3
30	N1B03058			
35	N1B03558			
45	N1B04558			

H  
L  
P

Misure in cm  
Measures in cm  
Mesures en cm  
Maße in cm

**F1** Laccato opaco  
Matt lacquered  
Laqué mat  
Matt lackiert

**F2** Laccato lucido  
Glossy lacquered  
Laqué brillant  
Hochglanz lackiert

**F3** Nobilitati  
Veneer wood  
Placage bois  
Beschichtetes Holz

**F4** Arock®  
Arock®  
Arock®  
Arock®

**F5** abitat / vogue  
abitat / vogue  
abitat / vogue  
abitat / vogue

# Basi Units

# Meubles bas Unterschränke

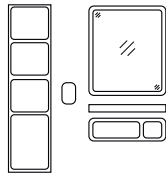

UNICAMENTE  
AROCK®

34

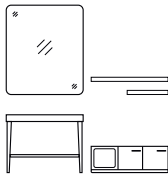

ALCENTIMETRO  
PROGETTO

98



Elementi  
CONTENTORI

180

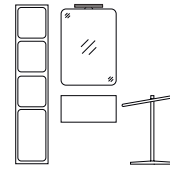

Elementi  
COMPLEMENTARI

226



RICAMBI

592

## H 40

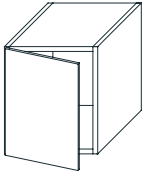

### P 45

Sistema Premi-Apri • base laterale sx • 1 anta  
Premi-Apri System • side unit • 1 door  
Système Premi-Apri • meuble bas latéral • 1 porte  
Premi-Apri System • Seitenschrank • 1 Tür

L		F1	F2	F3
30	N1B03009			
35	N1B03509			
45	N1B04509			

### P 51,5

L		F1	F2	F3
30	N1B03059			
35	N1B03559			
45	N1B04559			

## H 50

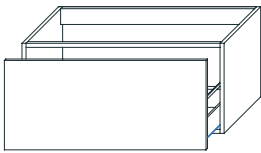

### P 45

Sistema Premi-Apri • base portalavabo • 1 cassetto  
Premi-Apri System • vanity unit • 1 pull out  
Système Premi-Apri • meuble sous vasque • 1 tiroir  
Premi-Apri System • Waschtischunterschrank • 1 Schublade

L		F1	F2	F3
60	N1L06019			
70	N1L07019			
80	N1L08019			
90	N1L09019			

### P 51,5

L		F1	F2	F3
60	N1L06069			
70	N1L07069			
80	N1L08069			
90	N1L09069			

## H 50

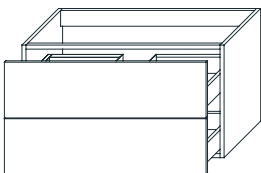

### P 45

Sistema Premi-Apri • base portalavabo • 2 cassetti • sifone incl.  
Premi-Apri System • vanity unit • 2 pull-out • siphon incl.  
Système Premi-Apri • meuble sous vasque • 2 tiroirs • siphon incl.  
Premi-Apri System • Waschtischunterschrank • 2 Schubladen • Siphon inkl.

L		F1	F2	F3
60	N1L06012			
70	N1L07012			
80	N1L08012			
90	N1L09012			
105	N1L10512			
120	N1L12012			

### P 51,5

L		F1	F2	F3
60	N1L06062			
70	N1L07062			
80	N1L08062			
90	N1L09062			
105	N1L10562			
120	N1L12062			



Misure in cm  
Measures in cm  
Mesures en cm  
Maße in cm

**F1** Laccato opaco  
Matt lacquered  
Laqué mat  
Matt lackiert

**F2** Laccato lucido  
Glossy lacquered  
Laqué brillant  
Hochglanz lackiert





**F3** Nobilitati  
Veneer wood  
Placage bois  
Beschichtetes Holz

**F4** Arock®  
Arock®  
Arock®  
Arock®

**F5** abitat / vogue  
abitat / vogue  
abitat / vogue  
abitat / vogue

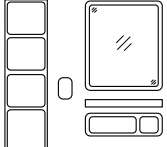
# Basi Units

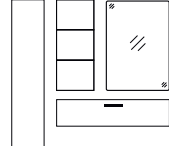
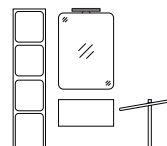
# Meubles bas Unterschränke

				
UNICAMENTE AROCK®	ALCENTIMETRO PROGETTO	Elementi CONTENITORI	Elementi COMPLEMENTARI	RICAMBI
34	98	180	226	592

## H 50

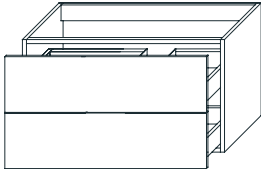

## P 45

Sistema Premi-Apri • base portalavabo • 2 cassetti • scasso per sifone dx  
 Premi-Apri System • vanity unit • 2 pull-out • right cavity for siphon  
 Système Premi-Apri • meuble sous vasque • 2 tiroirs • trou droite pour le siphon  
 Premi-Apri System • Waschtischunterschrank • 2 Schubladen • Siphonousschnitt-rechts

L	F1	F2	F3
105 N1L10516			

## P 51,5

L	F1	F2	F3
105 N1L10566			

## H 50

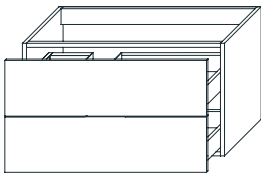

## P 45

Sistema Premi-Apri • base portalavabo • 2 cassetti • scasso per sifone sx  
 Premi-Apri System • vanity unit • 2 pull-out • left cavity for siphon  
 Système Premi-Apri • meuble sous vasque • 2 tiroirs • trou gauche pour le siphon  
 Premi-Apri System • Waschtischunterschrank • 2 Schubladen • Siphonousschnitt-links

L	F1	F2	F3
105 N1L10517			

## P 51,5

L	F1	F2	F3
105 N1L10567			

## H 50

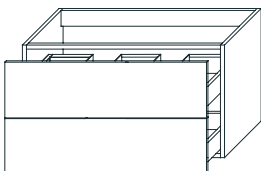

## P 45

Sistema Premi-Apri • base portalavabo • 2 cassetti • scasso per sifone doppio  
 Premi-Apri System • vanity unit • 2 pull-out • double cavity for siphon  
 Système Premi-Apri • meuble sous vasque • 2 tiroirs • trou pour le siphon double  
 Premi-Apri System • Waschtischunterschrank • 2 Schubladen • Siphonousschnitt-doppelt

L	F1	F2	F3
120 N1L12011			

## P 51,5

L	F1	F2	F3
120 N1L12061			

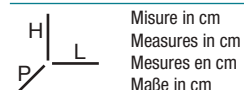

Misure in cm  
 Measures in cm  
 Mesures en cm  
 Maße in cm

**F1** Laccato opaco  
 Matt lacquered  
 Laqué mat  
 Matt lackiert

**F2** Laccato lucido  
 Glossy lacquered  
 Laqué brillant  
 Hochglanz lackiert

**F3** Nobilitati  
 Veneer wood  
 Placage bois  
 Beschichtetes Holz

**F4** Arock®  
 Arock®  
 Arock®  
 Arock®

**F5** abitat / vogue  
 abitat / vogue  
 abitat / vogue  
 abitat / vogue

# Basi Units

# Meubles bas Unterschranke

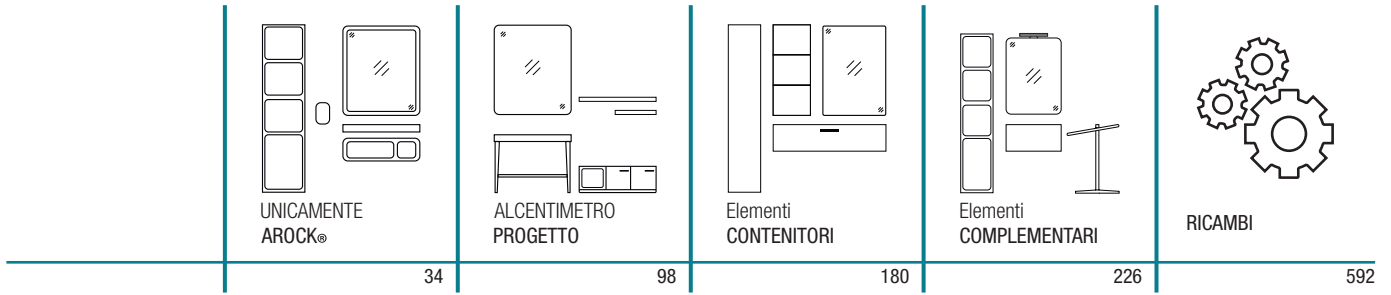

## H 50

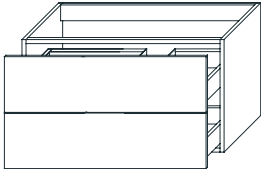

## P 45

Sistema Premi-Apri • base portalavabo • 2 cassetti • scasso per sifone dx  
 Premi-Apri System • vanity unit • 2 pull-out • right cavity for siphon  
 Système Premi-Apri • meuble sous vasque • 2 tiroirs • trou droite pour le siphon  
 Premi-Apri System • Waschtischunterschrank • 2 Schubladen • Siphonousschnitt-rechts

L	F1	F2	F3
120 N1L12014			

## P 51,5

L	F1	F2	F3
120 N1L12064			

## H 50

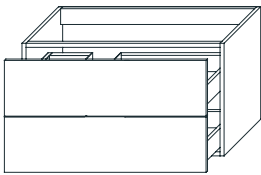

## P 45

Sistema Premi-Apri • base portalavabo • 2 cassetti • scasso per sifone sx  
 Premi-Apri System • vanity unit • 2 pull-out • left cavity for siphon  
 Système Premi-Apri • meuble sous vasque • 2 tiroirs • trou gauche pour le siphon  
 Premi-Apri System • Waschtischunterschrank • 2 Schubladen • Siphonousschnitt-links

L	F1	F2	F3
120 N1L12015			

## P 51,5

L	F1	F2	F3
120 N1L12065			

## H 50

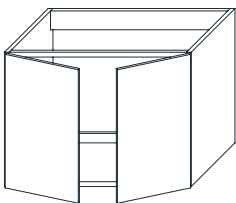

## P 45

Sistema Premi-Apri • base portalavabo • 2 ante • sifone incl.  
 Premi-Apri System • vanity unit • 2 doors • siphon incl.  
 Système Premi-Apri • meuble sous vasque • 2 portes • siphon incl.  
 Premi-Apri System • Waschtischunterschrank • 2 Türen • Siphon inkl.

L	F1	F2	F3
60 N1L06013			
70 N1L07013			
80 N1L08013			
90 N1L09013			

## P 51,5

L	F1	F2	F3
60 N1L06063			
70 N1L07063			
80 N1L08063			
90 N1L09063			



Misure in cm  
 Measures in cm  
 Mesures en cm  
 Maße in cm

**F1** Laccato opaco  
 Matt lacquered  
 Laqué mat  
 Matt lackiert

**F2** Laccato lucido  
 Glossy lacquered  
 Laqué brillant  
 Hochglanz lackiert





**F3** Nobilitati  
 Veneer wood  
 Placage bois  
 Beschichtetes Holz

**F4** Arock®  
 Arock®  
 Arock®  
 Arock®

**F5** abitat / vogue  
 abitat / vogue  
 abitat / vogue  
 abitat / vogue

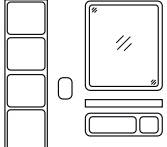
# Basi Units

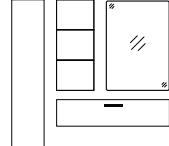
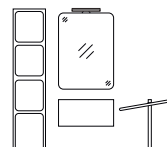
# Meubles bas Unterschränke

 UNICAMENTE AROCK®	 ALCENTIMETRO PROGETTO	 Elementi CONTENITORI	 Elementi COMPLEMENTARI	 RICAMBI
34	98	180	226	592

## H 50

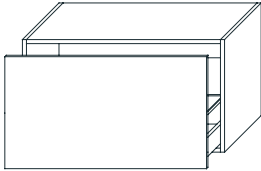

## P 45

Sistema Premi-Apri • base laterale • 1 cassetto + 1 ripiano  
 Premi-Apri System • side unit • 1 pull-out + 1 shelf  
 Système Premi-Apri • meuble bas latéral • 1 tiroir + 1 étagère  
 Premi-Apri System • Seitenschrank • 1 Schublade + 1 Regal

L		F1	F2	F3
30	N1B03019			
35	N1B03519			
45	N1B04519			
50	N1B05019			
60	N1B06019			
70	N1B07019			
90	N1B09019			
105	N1B10519			
120	N1B12019			

## P 51,5

L		F1	F2	F3
30	N1B03069			
35	N1B03569			
45	N1B04569			
50	N1B05069			
60	N1B06069			
70	N1B07069			
90	N1B09069			
105	N1B10569			
120	N1B12069			

## H 50

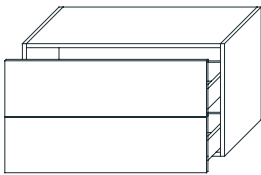

## P 45

Sistema Premi-Apri • base laterale • 2 cassetti  
 Premi-Apri System • side unit • 2 pull-out  
 Système Premi-Apri • meuble bas latéral • 2 tiroirs  
 Premi-Apri System • Seitenschrank • 2 Schubladen

L		F1	F2	F3
30	N1B03012			
35	N1B03512			
45	N1B04512			
50	N1B05012			
60	N1B06012			
70	N1B07012			
90	N1B09012			
105	N1B10512			
120	N1B12012			

## P 51,5

L		F1	F2	F3
30	N1B03062			
35	N1B03562			
45	N1B04562			
50	N1B05062			
60	N1B06062			
70	N1B07062			
90	N1B09062			
105	N1B10562			
120	N1B12062			

## H 50

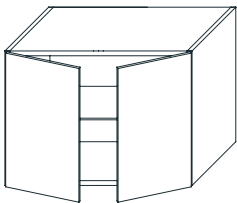

## P 45

Sistema Premi-Apri • base laterale • 2 ante + 1 ripiano  
 Premi-Apri System • side unit • 2 doors + 1 shelf  
 Système Premi-Apri • meuble bas latéral • 2 portes + 1 étagère  
 Premi-Apri System • Seitenschrank • 2 Türen + 1 Regal

L		F1	F2	F3
50	N1B05014			
60	N1B06014			
70	N1B07014			
90	N1B09014			

## P 51,5

L		F1	F2	F3
50	N1B05064			
60	N1B06064			
70	N1B07064			
90	N1B09064			

 H  
L  
P

Misure in cm  
 Mesures in cm  
 Mesures en cm  
 Maße in cm

**F1** Laccato opaco  
 Matt lacquered  
 Laqué mat  
 Matt lackiert

**F2** Laccato lucido  
 Glossy lacquered  
 Laqué brillant  
 Hochglanz lackiert

**F3** Nobilitati  
 Veneer wood  
 Placage bois  
 Beschichtetes Holz

**F4** Arock®  
 Arock®  
 Arock®  
 Arock®

**F5** abitat / vogue  
 abitat / vogue  
 abitat / vogue  
 abitat / vogue

# Basi Units

# Meubles bas Unterschränke

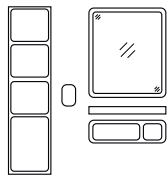

UNICAMENTE  
AROCK®

34

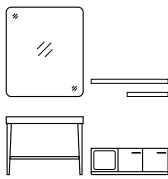

ALCENTIMETRO  
PROGETTO

98

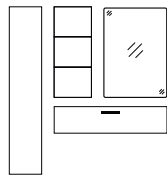

Elementi  
CONTENITORI

180

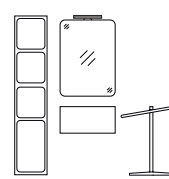

Elementi  
COMPLEMENTARI

226



RICAMBI

592

## H 50

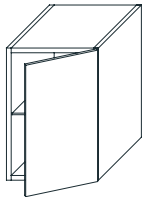

### P 45

Sistema Premi-Apri • base laterale dx • 1 anta + 1 ripiano  
Premi-Apri System • side unit • 1 door + 1 shelf  
Système Premi-Apri • meuble bas latéral • 1 porte + 1 étagère  
Premi-Apri System • Seitenschrank • 1 Tür + 1 Regal

L		F1	F2	F3
30	N1B03016			
35	N1B03516			
45	N1B04516			

### P 51,5

L		F1	F2	F3
30	N1B03066			
35	N1B03566			
45	N1B04566			

## H 50

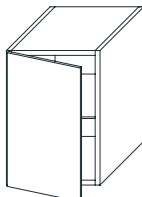

### P 45

Sistema Premi-Apri • base laterale sx • 1 anta + 1 ripiano  
Premi-Apri System • side unit • 1 door + 1 shelf  
Système Premi-Apri • meuble bas latéral • 1 porte + 1 étagère  
Premi-Apri System • Seitenschrank • 1 Tür + 1 Regal

L		F1	F2	F3
30	N1B03017			
35	N1B03517			
45	N1B04517			

### P 51,5

L		F1	F2	F3
30	N1B03067			
35	N1B03567			
45	N1B04567			

## H 75

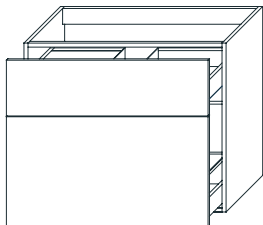

### P 45

Sistema Premi-Apri • base portlavabo • 2 cassetti • sifone incl.  
Premi-Apri System • vanity unit • 2 pull-out • siphon incl.  
Système Premi-Apri • meuble sous vasque • 2 tiroirs • siphon incl.  
Premi-Apri System • Waschtischunterschrank • 2 Schubladen • Siphon inkl.

L		F1	F2	F3
60	N1L06022			
70	N1L07022			
80	N1L08022			
90	N1L09022			
105	N1L10522			
120	N1L12022			

### P 51,5

L		F1	F2	F3
60	N1L06072			
70	N1L07072			
80	N1L08072			
90	N1L09072			
105	N1L10572			
120	N1L12072			



Misure in cm  
Measures in cm  
Mesures en cm  
Maße in cm

**F1** Laccato opaco  
Matt lacquered  
Laqué mat  
Matt lackiert

**F2** Laccato lucido  
Glossy lacquered  
Laqué brillant  
Hochglanz lackiert





**F3** Nobilitati  
Veneer wood  
Placage bois  
Beschichtetes Holz

**F4** Arock®  
Arock®  
Arock®  
Arock®

**F5** abitat / vogue  
abitat / vogue  
abitat / vogue  
abitat / vogue

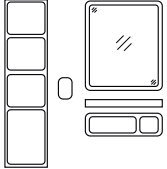
# Basi Units

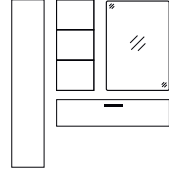
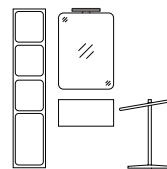
# Meubles bas Unterschränke

				
UNICAMENTE AROCK®	ALCENTIMETRO PROGETTO	Elementi CONTENITORI	Elementi COMPLEMENTARI	RICAMBI
34	98	180	226	592

## H 75

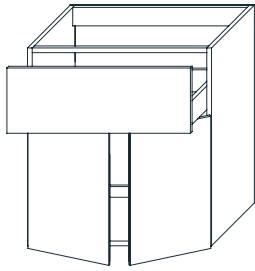

## P 45

Sistema Premi-Apri • base portalavabo • 1 cassetto + 2 ante • sifone incl.  
 Premi-Apri System • vanity unit • 1 pull-out + 2 doors • siphon incl.  
 Système Premi-Apri • meuble sous vasque • 1 tiroir + 2 portes • siphon incl.  
 Premi-Apri System • Waschtischunterschrank • 1 Schublade + 2 Türen • Siphon inkl.

L		F1	F2	F3
60	N1L06023			
70	N1L07023			
80	N1L08023			
90	N1L09023			

## P 51,5

L		F1	F2	F3
60	N1L06073			
70	N1L07073			
80	N1L08073			
90	N1L09073			

## H 75

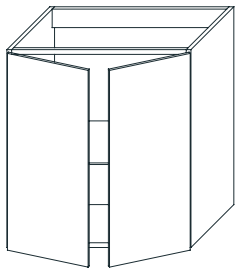

## P 45

Sistema Premi-Apri • base portalavabo • 2 ante + 1 ripiano • sifone incl.  
 Premi-Apri System • vanity unit • 2 doors + 1 shelf • siphon incl.  
 Système Premi-Apri • meuble sous vasque • 2 portes + 1 étagère • siphon incl.  
 Premi-Apri System • Waschtischunterschrank • 2 Türen + 1 Regal • Siphon inkl.

L		F1	F2	F3
60	N1L06024			
70	N1L07024			
80	N1L08024			
90	N1L09024			

## P 51,5

L		F1	F2	F3
60	N1L06074			
70	N1L07074			
80	N1L08074			
90	N1L09074			

## H 75

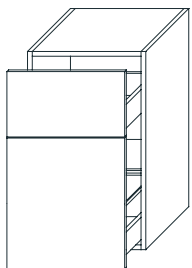

## P 45

Sistema Premi-Apri • base laterale • 2 cassetti + 1 ripiano  
 Premi-Apri System • side unit • 2 pull-out + 1 shelf  
 Système Premi-Apri • meuble bas latéral • 2 tiroirs + 1 étagère  
 Premi-Apri System • Seitenschrank • 2 Schubladen + 1 Regal

L		F1	F2	F3
30	N1B03025			
35	N1B03525			
45	N1B04525			
50	N1B05025			
60	N1B06025			

## P 51,5

L		F1	F2	F3
30	N1B03075			
35	N1B03575			
45	N1B04575			
50	N1B05075			
60	N1B06075			

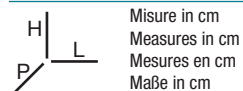

Misure in cm  
 Measures in cm  
 Mesures en cm  
 Maße in cm

**F1** Laccato opaco  
 Matt lacquered  
 Laqué mat  
 Matt lackiert

**F2** Laccato lucido  
 Glossy lacquered  
 Laqué brillant  
 Hochglanz lackiert

**F3** Nobilitati  
 Veneer wood  
 Placage bois  
 Beschichtetes Holz

**F4** Arock®  
 Arock®  
 Arock®  
 Arock®

**F5** abitat / vogue  
 abitat / vogue  
 abitat / vogue  
 abitat / vogue

# Basi Units

# Meubles bas Unterschränke

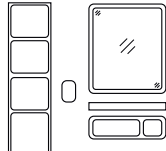

UNICAMENTE  
AROCK®

34



ALCENTIMETRO  
PROGETTO

98

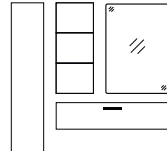

Elementi  
CONTENITORI

180

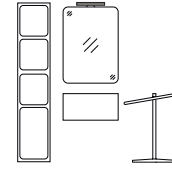

Elementi  
COMPLEMENTARI

226



RICAMBI

592

## H 75

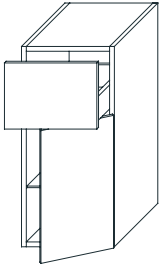

## P 45

Sistema Premi-Apri • base laterale dx • 1 cassetto + 1 anta + 1 ripiano  
 Premi-Apri System • side unit • 1 pull-out + 1 door + 1 shelf  
 Système Premi-Apri • meuble bas latéral • 1 tiroir + 1 porte + 1 étagère  
 Premi-Apri System • Seitenschrank • 1 Schublade + 1 Tür + 1 Regal

L		F1	F2	F3
30	N1B03026			
35	N1B03526			
45	N1B04526			

## P 51,5

L		F1	F2	F3
30	N1B03076			
35	N1B03576			
45	N1B04576			

## H 75

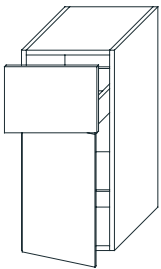

## P 45

Sistema Premi-Apri • base laterale sx • 1 cassetto + 1 anta + 1 ripiano  
 Premi-Apri System • side unit • 1 pull-out + 1 door + 1 shelf  
 Système Premi-Apri • meuble bas latéral • 1 tiroir + 1 porte + 1 étagère  
 Premi-Apri System • Seitenschrank • 1 Schublade + 1 Tür + 1 Regal

L		F1	F2	F3
30	N1B03027			
35	N1B03527			
45	N1B04527			

## P 51,5

L		F1	F2	F3
30	N1B03077			
35	N1B03577			
45	N1B04577			

## H 75

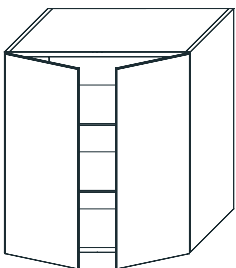

## P 45

Sistema Premi-Apri • base laterale • 2 ante + 2 ripiani  
 Premi-Apri System • side unit • 2 doors + 2 shelves  
 Système Premi-Apri • meuble bas latéral • 2 portes + 2 étagères  
 Premi-Apri System • Seitenschrank • 2 Türen + 2 Regale

L		F1	F2	F3
50	N1B05029			
60	N1B06029			
70	N1B07029			
90	N1B09029			

## P 51,5

L		F1	F2	F3
50	N1B05079			
60	N1B06079			
70	N1B07079			
90	N1B09079			

H  
L  
P

Misure in cm  
 Measures in cm  
 Mesures en cm  
 Maße in cm

**F1** Laccato opaco  
 Matt lacquered  
 Laqué mat  
 Matt lackiert

**F2** Laccato lucido  
 Glossy lacquered  
 Laqué brillant  
 Hochglanz lackiert

**F3** Nobilitati  
 Veneer wood  
 Placage bois  
 Beschichtetes Holz

**F4** Arock®  
 Arock®  
 Arock®  
 Arock®

**F5** abitat / vogue  
 abitat / vogue  
 abitat / vogue  
 abitat / vogue



# Basi Units

# Meubles bas Unterschränke

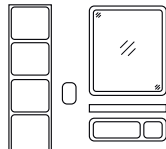

UNICAMENTE  
AROCK®

34

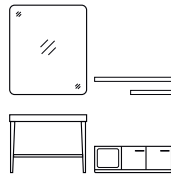

ALCENTIMETRO  
PROGETTO

98

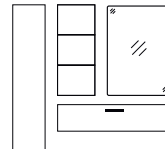

Elementi  
CONTENITORI

180

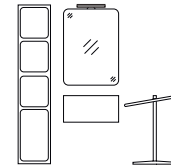

Elementi  
COMPLEMENTARI

226



RICAMBI

592

## H 75

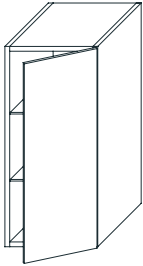

## P 45

Sistema Premi-Apri • base laterale dx • 1 anta + 2 ripiani  
Premi-Apri System • side unit • 1 door + 2 shelves  
Système Premi-Apri • meuble bas latéral • 1 porte + 2 étagères  
Premi-Apri System • Seitenschrank • 1 Tür + 2 Regale

L		F1	F2	F3
30	N1B03030			
35	N1B03530			
45	N1B04530			

## P 51,5

L		F1	F2	F3
30	N1B03080			
35	N1B03580			
45	N1B04580			

## H 75

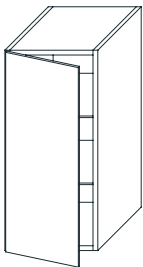

## P 45

Sistema Premi-Apri • base laterale sx • 1 anta + 2 ripiani  
Premi-Apri System • side unit • 1 door + 2 shelves  
Système Premi-Apri • meuble bas latéral • 1 porte + 2 étagères  
Premi-Apri System • Seitenschrank • 1 Tür + 2 Regale

L		F1	F2	F3
30	N1B03031			
35	N1B03531			
45	N1B04531			

## P 51,5

L		F1	F2	F3
30	N1B03081			
35	N1B03581			
45	N1B04581			

## H 87

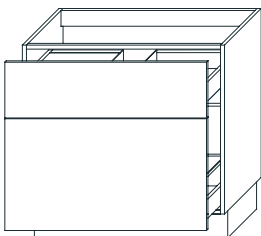

## P 45

Sistema Premi-Apri • base portlavabo • 2 cassetti • zoccolo H 12 + sifone incl.  
Premi-Apri System • vanity unit • 2 pull-out • toe-kick H 12 + siphon incl.  
Système Premi-Apri • meuble sous vasque • 2 tiroirs • socle H 12 + siphon incl.  
Premi-Apri System • Waschtischunterschrank • 2 Schubladen • Sockel H 12 + Siphon inkl.

L		F1	F2	F3
60	N1L06034			
70	N1L07034			
80	N1L08034			
90	N1L09034			
105	N1L10534			
120	N1L12034			

## P 51,5

L		F1	F2	F3
60	N1L06084			
70	N1L07084			
80	N1L08084			
90	N1L09084			
105	N1L10584			
120	N1L12084			

H  
L  
P

Misure in cm  
Measures in cm  
Mesures en cm  
Maße in cm

**F1** Laccato opaco  
Matt lacquered  
Laqué mat  
Matt lackiert

**F2** Laccato lucido  
Glossy lacquered  
Laqué brillant  
Hochglanz lackiert

**F3** Nobilitati  
Veneer wood  
Placage bois  
Beschichtetes Holz

**F4** Arock®  
Arock®  
Arock®  
Arock®

**F5** abitat / vogue  
abitat / vogue  
abitat / vogue  
abitat / vogue

# Basi Units

# Meubles bas Unterschränke

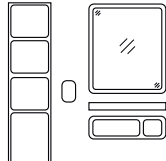

UNICAMENTE  
AROCK®

34



ALCENTIMETRO  
PROGETTO

98

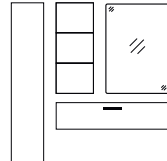

Elementi  
CONTENITORI

180

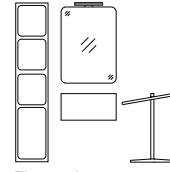

Elementi  
COMPLEMENTARI

226



RICAMBI

592

## H 87

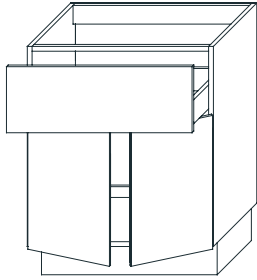

## P 45

Sistema Premi-Apri • base portalavabo • 1 cassetto + 2 ante • zoccolo H 12 + sifone incl.  
 Premi-Apri System • vanity unit • 1 pull-out + 2 doors • toe-kick H 12 + siphon incl.  
 Système Premi-Apri • meuble sous vasque • 1 tiroir + 2 portes • socle H 12 + siphon incl.  
 Premi-Apri System • Waschtischunterschrank • 1 Schublade + 2 Türen • Sockel H 12 + Siphon inkl.

L		F1	F2	F3
60	N1L06035			
70	N1L07035			
80	N1L08035			
90	N1L09035			

## P 51,5

L		F1	F2	F3
60	N1L06085			
70	N1L07085			
80	N1L08085			
90	N1L09085			

## H 87

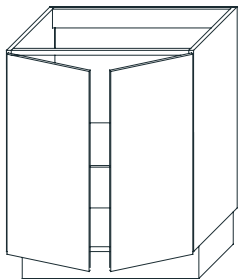

## P 45

Sistema Premi-Apri • base portalavabo • 2 ante + 1 ripiano • zoccolo H 12 + sifone incl.  
 Premi-Apri System • vanity unit • 2 doors + 1 shelf • toe-kick H 12 + siphon incl.  
 Système Premi-Apri • meuble sous vasque • 2 portes + 1 étagère • socle H 12 + siphon incl.  
 Premi-Apri System • Waschtischunterschrank • 2 Türen + 1 Regal • Sockel H 12 + Siphon inkl.

L		F1	F2	F3
60	N1L06036			
70	N1L07036			
80	N1L08036			
90	N1L09036			

## P 51,5

L		F1	F2	F3
60	N1L06086			
70	N1L07086			
80	N1L08086			
90	N1L09086			

## H 87

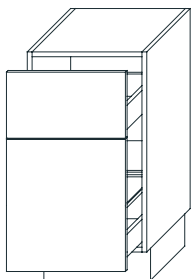

## P 45

Sistema Premi-Apri • base laterale • 2 cassetti + 1 ripiano • zoccolo H 12 incl.  
 Premi-Apri System • side unit • 2 pull-out + 1 shelf • toe-kick H 12 incl.  
 Système Premi-Apri • meuble bas latéral • 2 tiroirs + 1 étagère • socle H 12 incl.  
 Premi-Apri System • Seitenschrank • 2 Schubladen + 1 Regal • Socle H 12 inkl.

L		F1	F2	F3
30	N1B03037			
35	N1B03537			
45	N1B04537			
50	N1B05037			
60	N1B06037			

## P 51,5

L		F1	F2	F3
30	N1B03087			
35	N1B03587			
45	N1B04587			
50	N1B05087			
60	N1B06087			



Misure in cm  
 Measures in cm  
 Mesures en cm  
 Maße in cm

**F1** Laccato opaco  
 Matt lacquered  
 Laqué mat  
 Matt lackiert

**F2** Laccato lucido  
 Glossy lacquered  
 Laqué brillant  
 Hochglanz lackiert





**F3** Nobilitati  
 Veneer wood  
 Placage bois  
 Beschichtetes Holz

**F4** Arock®  
 Arock®  
 Arock®  
 Arock®

**F5** abitat / vogue  
 abitat / vogue  
 abitat / vogue  
 abitat / vogue

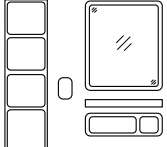
# Basi Units

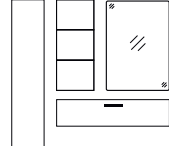
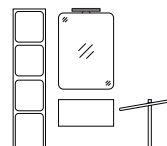
# Meubles bas Unterschränke

				
UNICAMENTE AROCK®	ALCENTIMETRO PROGETTO	Elementi CONTENITORI	Elementi COMPLEMENTARI	RICAMBI
34	98	180	226	592

## H 87

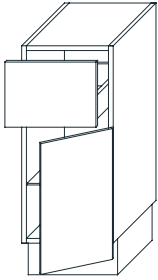

## P 45

Sistema Premi-Apri • base laterale dx • 1 cassetto + 1 anta + 1 ripiano • zoccolo H 12 incl.  
 Premi-Apri System • side unit • 1 pull-out + 1 door + 1 shelf • toe-kick H 12 incl.  
 Système Premi-Apri • meuble bas latéral • 1 tiroir + 1 porte + 1 étagère • socle H 12 incl.  
 Premi-Apri System • Seitenschrank • 1 Schublade + 1 Tür + 1 Regal • Socle H 12 inkl.

L		F1	F2	F3
30	N1B03038			
35	N1B03538			
45	N1B04538			

## P 51,5

L		F1	F2	F3
30	N1B03088			
35	N1B03588			
45	N1B04588			

## H 87

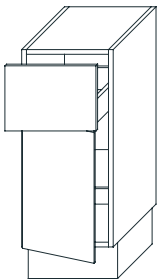

## P 45

Sistema Premi-Apri • base laterale sx • 1 cassetto + 1 anta + 1 ripiano • zoccolo H 12 incl.  
 Premi-Apri System • side unit • 1 pull-out + 1 door + 1 shelf • toe-kick H 12 incl.  
 Système Premi-Apri • meuble bas latéral • 1 tiroir + 1 porte + 1 étagère • socle H 12 incl.  
 Premi-Apri System • Seitenschrank • 1 Schublade + 1 Tür + 1 Regal • Socle H 12 inkl.

L		F1	F2	F3
30	N1B03039			
35	N1B03539			
45	N1B04539			

## P 51,5

L		F1	F2	F3
30	N1B03089			
35	N1B03589			
45	N1B04589			

## H 87

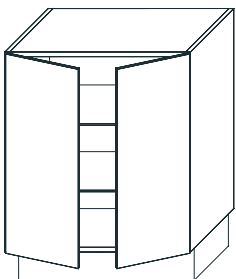

## P 45

Sistema Premi-Apri • base laterale • 2 ante + 2 ripiani • zoccolo H 12 incl.  
 Premi-Apri System • side unit • 2 doors + 2 shelves • toe-kick H 12 incl.  
 Système Premi-Apri • meuble bas latéral • 2 portes + 2 étagères • socle H 12 incl.  
 Premi-Apri System • Seitenschrank • 2 Türen + 2 Regale • Socle H 12 inkl.

L		F1	F2	F3
50	N1B05041			
60	N1B06041			
70	N1B07041			
90	N1B09041			

## P 51,5

L		F1	F2	F3
50	N1B05091			
60	N1B06091			
70	N1B07091			
90	N1B09091			

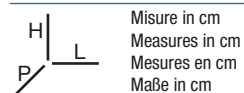

Misure in cm  
 Measures in cm  
 Mesures en cm  
 Maße in cm

**F1** Laccato opaco  
 Matt lacquered  
 Laqué mat  
 Matt lackiert

**F2** Laccato lucido  
 Glossy lacquered  
 Laqué brillant  
 Hochglanz lackiert

**F3** Nobilitati  
 Veneer wood  
 Placage bois  
 Beschichtetes Holz

**F4** Arock®  
 Arock®  
 Arock®  
 Arock®

**F5** abitat / vogue  
 abitat / vogue  
 abitat / vogue  
 abitat / vogue

# Basi Units

# Meubles bas Unterschränke

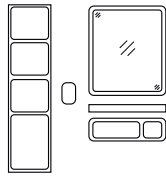

UNICAMENTE  
AROCK®

34



ALCENTIMETRO  
PROGETTO

98

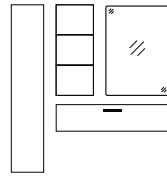

Elementi  
CONTENITORI

180

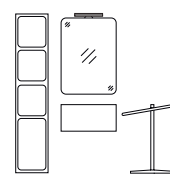

Elementi  
COMPLEMENTARI

226



RICAMBI

592

## H 87

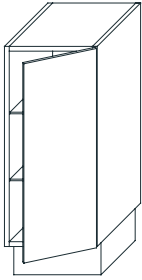

## P 45

Sistema Premi-Apri • base laterale dx • 1 anta + 2 ripiani • zoccolo H 12 incl.  
 Premi-Apri System • side unit • 1 door + 2 shelves • toe-kick H 12 incl.  
 Système Premi-Apri • meuble bas latéral • 1 porte + 2 étagères • socle H 12 incl.  
 Premi-Apri System • Seitenschrank • 1 Tür + 2 Regale • Socle H 12 inkl.

L		F1	F2	F3
30	N1B03042			
35	N1B03542			
45	N1B04542			

## P 51,5

L		F1	F2	F3
30	N1B03092			
35	N1B03592			
45	N1B04592			

## H 87

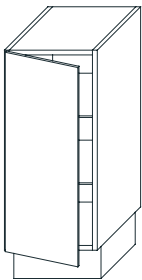

## P 45

Sistema Premi-Apri • base laterale sx • 1 anta + 2 ripiani • zoccolo H 12 incl.  
 Premi-Apri System • side unit • 1 door + 2 shelves • toe-kick H 12 incl.  
 Système Premi-Apri • meuble bas latéral • 1 porte + 2 étagères • socle H 12 incl.  
 Premi-Apri System • Seitenschrank • 1 Tür + 2 Regale • Socle H 12 inkl.

L		F1	F2	F3
30	N1B03043			
35	N1B03543			
45	N1B04543			

## P 51,5

L		F1	F2	F3
30	N1B03093			
35	N1B03593			
45	N1B04593			



Misure in cm  
 Measures in cm  
 Mesures en cm  
 Maße in cm

**F1** Laccato opaco  
 Matt lacquered  
 Laqué mat  
 Matt lackiert

**F2** Laccato lucido  
 Glossy lacquered  
 Laqué brillant  
 Hochglanz lackiert





**F3** Nobilitati  
 Veneer wood  
 Placage bois  
 Beschichtetes Holz

**F4** Arock®  
 Arock®  
 Arock®  
 Arock®

**F5** abitat / vogue  
 abitat / vogue  
 abitat / vogue  
 abitat / vogue

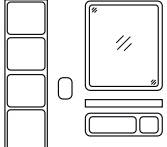
## Basi Units

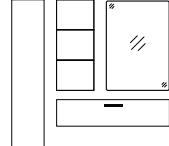
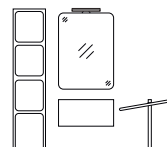
## Meubles bas Unterschränke

				
UNICAMENTE AROCK®	ALCENTIMETRO PROGETTO	Elementi CONTENITORI	Elementi COMPLEMENTARI	RICAMBI
34	98	180	226	592

### H 25

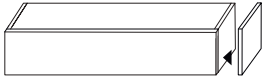

### P 45

Pannello terminale - FACOLTATIVO  
Terminal panel - OPTIONAL  
Panueau de finition latéral - OPTIONNEL  
Terminal Panel - OPTIONAL

L	F1	F2	F3
1	LEUFIN05		

### P 51,5

L	F1	F2	F3
1	LEUFIN35		

### H 40

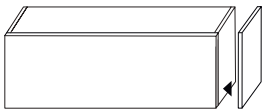

### P 45

Pannello terminale - FACOLTATIVO  
Terminal panel - OPTIONAL  
Panueau de finition latéral - OPTIONNEL  
Terminal Panel - OPTIONAL

L	F1	F2	F3
1	LEUFIN10		

### P 51,5

L	F1	F2	F3
1	LEUFIN40		

### H 50

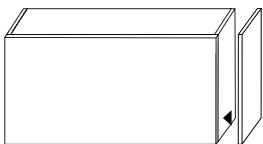

### P 45

Pannello terminale - FACOLTATIVO  
Terminal panel - OPTIONAL  
Panueau de finition latéral - OPTIONNEL  
Terminal Panel - OPTIONAL

L	F1	F2	F3
1	LEUFIN15		

### P 51,5

L	F1	F2	F3
1	LEUFIN45		

  
 Misure in cm  
 Measures in cm  
 Mesures en cm  
 Maße in cm

**F1** Laccato opaco  
 Matt lacquered  
 Laqué mat  
 Matt lackiert

**F2** Laccato lucido  
 Glossy lacquered  
 Laqué brillant  
 Hochglanz lackiert



**F3** Nobilitati  
 Veneer wood  
 Placage bois  
 Beschichtetes Holz

**F4** Arock®  
 Arock®  
 Arock®  
 Arock®

**F5** abitat / vogue  
 abitat / vogue  
 abitat / vogue  
 abitat / vogue

# Basi Units

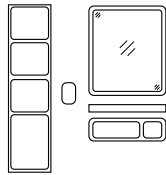
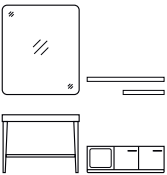
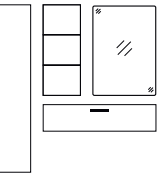
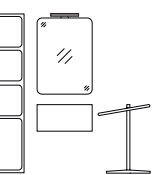
# Meubles bas Unterschränke

				
UNICAMENTE AROCK®	ALCENTIMETRO PROGETTO	Elementi CONTENTORI	Elementi COMPLEMENTARI	RICAMBI
34	98	180	226	592

## H 75

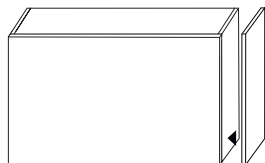

## P 45

Pannello terminale - FACOLTATIVO  
Terminal panel - OPTIONAL  
Panneau de finition latéral - OPTIONNEL  
Terminal Panel - OPTIONAL

<b>L</b>	<b>F1</b>	<b>F2</b>	<b>F3</b>
1	LEUFIN20		

## P 51,5

<b>L</b>	<b>F1</b>	<b>F2</b>	<b>F3</b>
1	LEUFIN50		



Misure in cm  
Measures in cm  
Mesures en cm  
Maße in cm

**F1** Laccato opaco  
Matt lacquered  
Laqué mat  
Matt lackiert

**F2** Laccato lucido  
Glossy lacquered  
Laqué brillant  
Hochglanz lackiert

**F3** Nobilitati  
Veneer wood  
Placage bois  
Beschichtetes Holz

**F4** Arock®  
Arock®  
Arock®  
Arock®

**F5** abitat / vogue  
abitat / vogue  
abitat / vogue  
abitat / vogue





Il Cristo Redentore è una statua in stile Art Dèco collocata sulla cima della montagna del Corcovado, alta 38 metri di cui 8 fanno parte del basamento, realizzata da Paul Landowski e Heitor Da Silva. Costruita nel 1930 in calcestruzzo e pietra saponaria è il simbolo della capitale del Brasile e dal 2007 è inserita fra le Sette Meraviglie del Mondo Moderno





Cristo Redentor is an Art D coco statue located on the top of the Corcovado mountain. It is 38 m tall, 8 m of which are part of the base. It was created in 1930 by Paul Landowski and Heitor Da Silva with concrete and soapstone. Cristo Redentor is the symbol of Brazil and, in 2007, it was included in the Modern World's Seven Wonders



MOBILI COMPONENTI

GIUSTO



# G I U S T O

entra nella categoria dei prodotti disegnati per la stanza da bagno scegliendo di proporre elementi utili e dimensioni pratiche

presenta un pensiero estetico globalizzante come fattore competitivo a supporto di una sicura esperienza tecnica

aggiunge al valore primordiale del concetto di pulizia e igiene il valore poetico del colore

cette série de meubles conçus pour la salle de bain offre des éléments utiles et des dimensions pratiques

il présente une philosophie esthétique italienne comme facteur compétitif qui soutient une expertise technique consolidée

il ajoute au sens culturel de nettoyage et hygiène la valeur poétique de la couleur



it falls under the category of the traditional bath products, featuring useful elements and practical dimensions

it embodies an Italic aesthetic philosophy as a competitive factor supporting a solid technical experience

it adds to the cultural value of tidiness and hygiene the graphic value of Arock® traces and the poetic value of the colors

fällt in die Kategorie der Produkte, die traditionell in Badezimmern weit verbreitet sind, mit einer Auswahl an nützlichen Elementen und an praktischen Maßen

es präsentiert ein ästhetisches Denken zur Unterstützung einer Fachwissen

der ursprüngliche Wert des Begriffs von Sauberkeit und Hygiene wird mit dem Wert der Farbe ergänzt





**A** piano / top / plan / Platte

<b>TIPOLOGIE:</b> filopiano lavabo integrato; per lavabo sopra piano da appoggio e da incasso e sottopiano da incasso <b>PROFONDITA':</b> 45-51,5 cm <b>FINITURE:</b> Arock® - HPL - Nobilitato LEGNO/ALTATTO - Laccato OPACO/ LUCIDO - GRES - PIETRA NATURALE - SILESTONE - CRISTALLO	<b>TYPES:</b> integrated plan washbasin; for countertop basin, recessed basin and undermounted basin <b>DEPTH:</b> 45-51.5 cm <b>FINISHES:</b> Arock® - HPL - Nobilitato LEGNO/ALTATTO - Laquered MATT/ GLOSSY - GRES - NATURAL STONE - SILESTONE	<b>TYPOLOGIES:</b> lavabo intégré au plan; pour lavabo à poser, lavabo encastré surélevé et lavabo encastré <b>PROFONDEUR:</b> 45-51,5 cm <b>FINITIONS:</b> Arock® - HPL - Mé laminé BOIS/ALTATTO - Laque MAT/BRIL- LANT - GRES - PIERRE NATURELLE - SILESTONE	<b>TYPOLOGIEN:</b> integriertes Waschbecken; für Aufsatzwaschtisch, Halbeinbau- becken und Einbauwaschtisch <b>TIEFE:</b> 45-51,5 cm <b>AUSFÜHRUNGEN:</b> Arock® - HPL - Melamin HOL /ALTATTO - MATT/ HOCHGLANZ Lack - GRES - NATUR- STEIN - SILESTONE
--	---	--	--

**B** contenitore / interior configuration / configuration intérieure / Innenausstattung

realizzato in pannelli di particelle di legno di spessore 16 mm, idrofughi, nobilitato con carta melaminica colore URBAN. Bordi in ABS in tinta. Cassetto montato su guide GRASS® ad estrazione totale con sponde laterali in metallo verniciato colore URBAN. Fondo e schienale nella finitura del contenitore <b>ALTEZZA :</b> 37-55,5 cm <b>PROFONDITA':</b> 45-51,5 cm <b>LARGHEZZA:</b> 27-36-54-63-72-81- 90-108 cm	made of water repellent panels of 16 mm thick wood particles, covered with Nobilitato URBAN color. Matching ABS edges Drawer mounted on full extension GRASS® runners with URBAN color painted metal sides. Bottom and back in the finish of the container <b>HEIGHT:</b> 37-55,5-74 cm <b>DEPTH:</b> 45-51,5 cm <b>WIDTH:</b> 27-36-54-63-72-81-90- 108 cm	en panneaux hydrofuges en particules de bois de 16 mm d'épaisseur. Re- couvert de papier mélaminé couleur URBAN. Bords ABS de la même couleur Tiroir monté sur coulisses GRASS® pleine extension avec côtés en métal peint couleur URBAN. Fond et retour dans la finition du intérieur <b>HAUTEUR:</b> 37-55,5-74 cm <b>PROFONDEUR:</b> 45-51,5 cm <b>LARGEUR:</b> 27-36-54-63-72-81-90- 108 cm	in wasserabweisenden Platten aus 16 mm starken Holzpartikeln. Farb- melaminpapier und ABS Kanten der gleichen Farbe Schublade montiert auf GRASS® Vollauszügen mit URBAN-farbig lackierten Metallseiten. Boden und Rückseite im Abgang des Behälters <b>HÖHE:</b> 37-55,5-74 cm <b>TIEFE:</b> 45-51,5 cm <b>BREITE:</b> 27-36-54-63-72-81-90-108 cm
---	--	---	--

**C** frontali / front panels / tiroirs / Schublade

realizzato in pannelli di particelle di legno idrofugo nobilitato con carta melaminica <b>SPESORE:</b> 1,8 cm <b>FINITURE:</b> Laccato OPACO/LUCIDO 48 colori.02 - Nobilitato LEGNO/ALTATTO	made of water repellent panels of wood particles <b>THICKNESS:</b> 1,8 cm <b>FINISHES:</b> MATT/GLOSSY Lacquered 48 colori.02 - Nobilitato LEGNO/ ALTATTO	en panneaux hydrofuges en particules de bois recouvert de papier mélaminé <b>ÉPAISSEUR:</b> 1,8 cm <b>FINITIONS:</b> Laqué MAT/BRILLANT en 48 colori.02 - Nobilitato LEGNO/ ALTATTO	aus wasserabweisenden Spanplatten, veredelt mit Melaminpapier <b>DICKE:</b> 1,8 cm <b>OBERFLÄCHEN:</b> MATT/HOCHGLANZ Lack aus 48 colori.02 - Nobilitato LEGNO/ALTATTO
--	--	--	---

**D** apertura / opening system / système d'ouverture / Öffnungssystem

fascia maniglia in alluminio verniciato	painted alu. handle-profile	profil poignée en aluminium laqué	Griffprofil aus lackiertem Aluminium
---	-----------------------------	-----------------------------------	--------------------------------------

**E** pannelli terminali / terminal panles / panneaux lateraux / seitliche Panele

<b>OBBLIGATORI</b> realizzati in pannelli di particelle di legno <b>SPESORE:</b> 1 cm <b>FINITURE:</b> Laccato OPACO/LUCIDO in 48 colori.02 - Nobilitato LEGNO/ ALTATTO	<b>REQUIRED</b> made of water repellent panels of wood particles <b>THICKNESS:</b> 1 cm <b>FINISHES:</b> MATT/GLOSSY Lacquered 48 colori.02 - Nobilitato LEGNO/ ALTATTO	<b>OBLIGATOIRE</b> panneaux hydrofuges en particules de bois <b>ÉPAISSEUR:</b> 1 cm <b>FINITIONS:</b> Laqué MAT/BRILLANT en 48 colori.02 - Nobilitato LEGNO/ ALTATTO	<b>WICHTIG</b> aus wasserabweisenden Spanplatten, veredelt mit Melaminpapier <b>DICKE:</b> 1 cm <b>OBERFLÄCHEN:</b> MATT/HOCHGLANZ Lack aus 48 colori.02 - Nobilitato LEGNO/ALTATTO
---	---	--	---

**frontale unico estraibile**  
**single drawer**  
**meuble avec un tiroir**  
**Möbel mit ein Schublade**

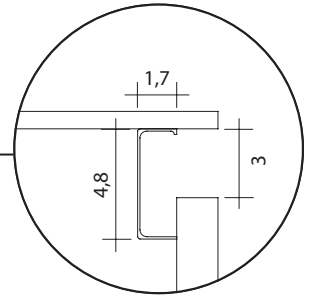
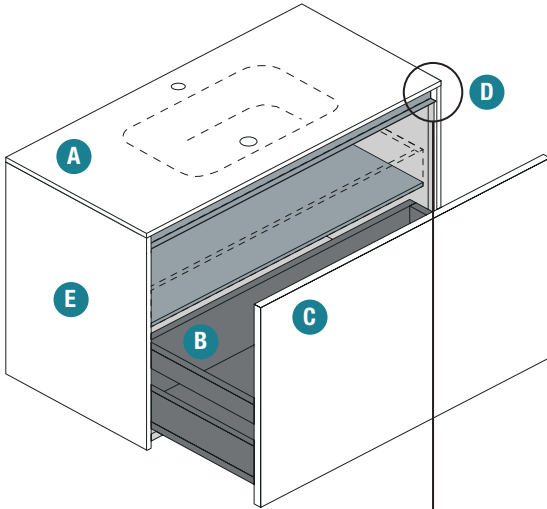

**doppio frontale estraibile**  
**double drawer**  
**meuble avec deux tiroirs**  
**Möbel mit zwei Schubladen**

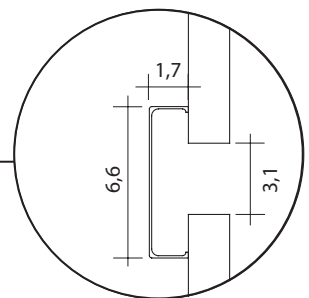
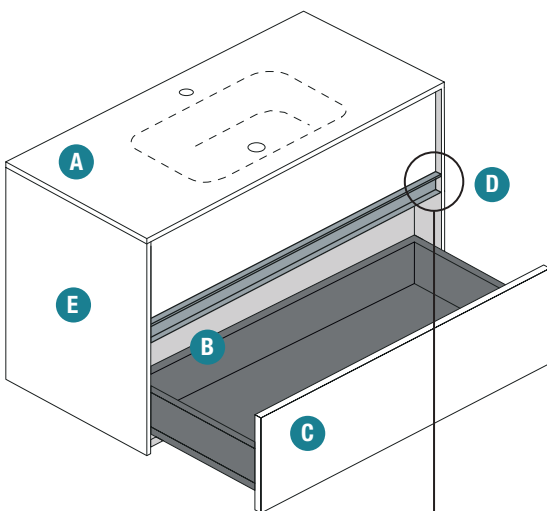

**Nobilitato LEGNO**

pannello di particelle di legno spessore 18 mm idrofugo a basso contenuto di formaldeide nobilitato interno ed esterno con carta melaminica in finitura LEGNO riprodotto ad alta fedeltà; bordo in ABS in finitura

high pressure layered laminate, a perfect and strong imitation of the natural wooden surface

stratifiés décoratifs haute pression. Plaques à base de résines thermoscurcissables appelées stratifiés

Hochdruckmehrschichtlaminat mit einer dreidimensionalen Erscheinung

**Nobilitato ALTATTO****laccato OPACO / LUCIDO  
MATT / GLOSSY lacquered**

pannello di particelle di legno, idrofugo, a basso contenuto di formaldeide, verniciato con resine poliuretaniche pigmentate opache o lucide

wood particles panel 18 mm with low formaldehyde content, painted with polyurethane resins

**laqué MAT / BRILLANT  
MATT / HOCHGLANZ lackiert**

panneaux de particules de bois 18 mm à faible teneur en formaldéhyde, peint avec des résines de polyuréthane

Holzpartikelplatte 18 mm mit niedrigem Formaldehydgehalt, mit Polyurethanharzen lackiert

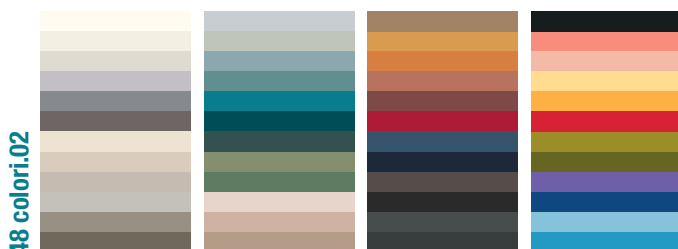



**Fascia maniglia****FINITURE:**

. laccato OPACO 48 **colori.02**  
. extra pag. 592



ALLUMINIO

**Handle profile****FINISHES:**

. MATT lacquered 48 **colori.02**  
. extra pag. 592

**Profil poignée****FINITIONS:**

. laqué MAT 48 **colori.02**  
. extra pag. 592

**Griffprofil****OBERFLÄCHEN:**

. MATT lackiert 48 **colori.02**  
. extra pag. 592

**abbinamento consigliato mobile/maniglia**  
**combinations furniture/handle**
**coordinations meuble/poignée**  
**Griffeabstimmung**

mobile Nobilitato LEGNO

	12W ABETE BIANCO
	14W ABETE BROWN
	26W ABETE ROCCIA
	27W ABETE FONDENTE
	31W FRONDA PURO
	32W FRONDA LIEVE
	33W FRONDA NUDO
	34W FRONDA ARCANO



maniglia laccato OPACO

	01 NUDE
	0H CURCUMA
	05 WILD
	0U MOCHA
	01 NUDE
	0G EARTH
	03 NATURE
	59 NERO

	01I ALTATTO LUNARE
	02I ALTATTO BIOTITE
	03I ALTATTO GENESI
	04I ALTATTO MARKINA



	13 ELEGANT GREY
	0U MOCHA
	16 DEEP GREY
	40 URBAN

i colori qui riportati sono da considerarsi indicativi  
 the colours can diverge from the reality  
 la fidélité des couleurs peut être différent de la réalité  
 bitte berücksichtigen Sie unsere Farbfächer zur Farbauswahl

UNICAMENTE

AROCK®

ALCENTIMETRO

PROGETTO

## piani / tops / plans / Platten



piano e piano d'arredo  
top for interior  
plan pour l'ameublement  
Platte fuer Einrichtung



piano e piano d'arredo accoppiato  
coated  
accouplé  
verdoppelt

## lavabo / basin / vasque / Becken

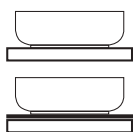

soprapiano da appoggio  
countertop basin  
lavabo à poser  
Aufsetzbecken

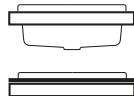

soprapiano da incasso  
recessed basin  
lavabo encastré surélevé  
Halbeinbaubecken

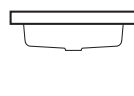

sottopiano da incasso  
undermounted basin  
lavabo en profondeur  
Unteneinbaubecken

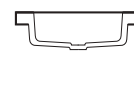

lavabo integrato  
integrated basin  
vasque intégrée  
integriertes Becken

	SP cm	P 45 cm	P 51,5 cm	
<b>AROCK®</b>	1,2 / 6			
<b>Laccato OPACO / LUCIDO</b>	1,8			
<b>Nobilitato LEGNO / ALTATTO</b>	1,8			
<b>Nobilitato LEGNO / ALTATTO + GRES</b> <b>Laccato OPACO / LUCIDO + GRES</b>	2,4			
<b>HPL</b>	1			
<b>GRES</b>	0,6 / 1,2			
	1,2			
<b>CRISTALLO extrachiaro verniciato</b> <b>extra-clear lacquered GLASS</b> <b>VERRE lacquée extraclair</b> <b>Hochglanz lackierte GLAS</b>	1,2			
<b>PIETRA NATURALE</b> <b>NATURAL STONE</b> <b>PIERRE NATURELLE</b> <b>NATURSTEIN</b>	2			
<b>SILESTONE</b>	1,2			







Modularità  
Modularity

Modularité  
Modularität

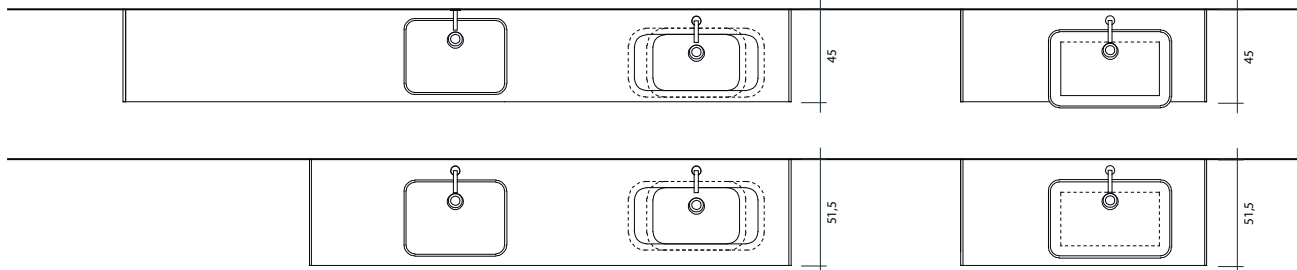
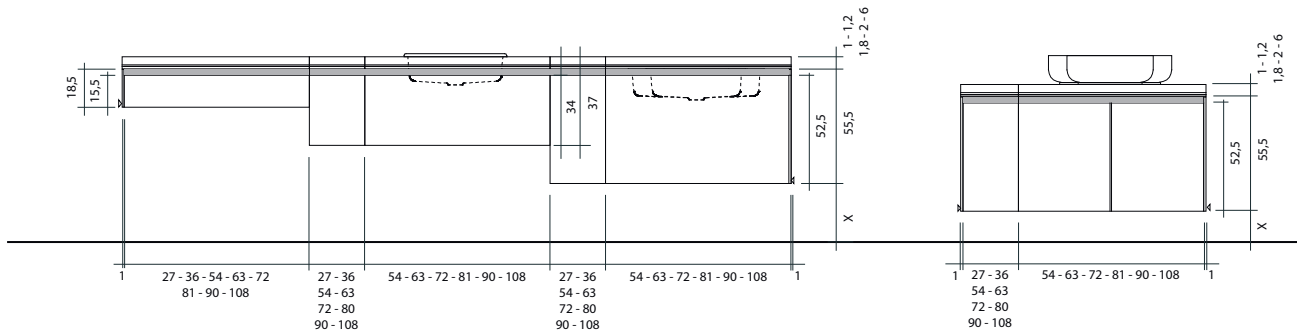
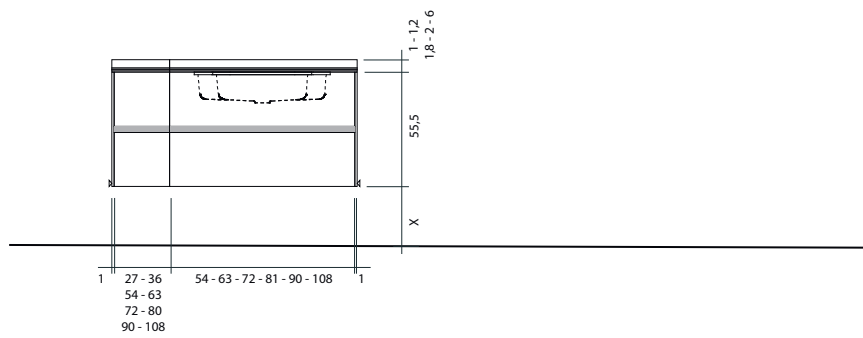

**basi portalavabo**  
**vanity units**  
**meubles sous-vasque**  
**Waschtischunterschänke**

L 54-63-72-81-90-108 cm

**basi laterali**  
**side units**  
**meubles bas latéraux**  
**Unterschänke**

L 27-36-54-63-72-81-90-108 cm

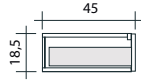

frontale unico estraibile con cassetto, chiusura ammortizzata  
 single pull-out, soft-closing  
 façade amovible avec tiroir  
 1 Schublade

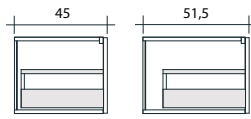
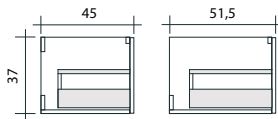

frontale unico estraibile con cassetto, chiusura ammortizzata  
 single pull-out, soft-closing  
 façade amovible avec tiroir  
 1 Schublade

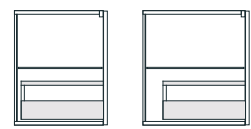
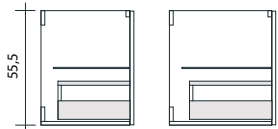

frontale unico estraibile con cassetto chiusura ammortizzata + 1 ripiano  
 single pull-out, soft-closing + 1 shelf  
 façade amovible avec tiroir + 1 étagère  
 1 Schublade + 1 Regal

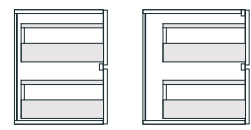
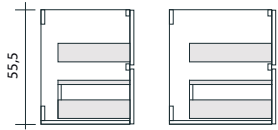

doppio frontale estraibile con cassetto, chiusura ammortizzata  
 2 removable fronts with drawer  
 2 façades amovible avec tiroir  
 2 Schublade

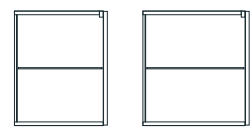
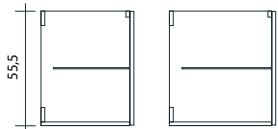



1 anta o 2 ante chiusura ammortizzata + 1 ripiano  
 single door or double door, soft-closing + 1 shelf  
 1 porte ou 2 portes + 1 étagère  
 1 Tür oder 2 Türen + 1 Regal

## Pannelli terminali obbligatori

### Required terminal panels

## Paneaux de finition latéral obligatoires

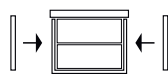
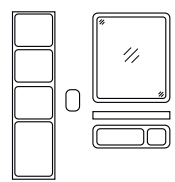
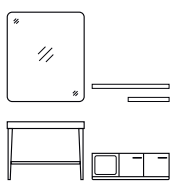
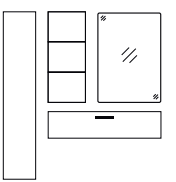
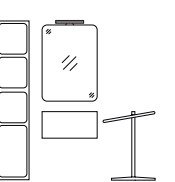
### Nötig terminal Panele

					
Terminale di finitura OBBLIGATORIO	UNICAMENTE AROCK®	ALCENTIMETRO PROGETTO	Elementi CONTENITORI	Elementi COMPLEMENTARI	RICAMBI
526	34	98	180	226	592

#### H 37

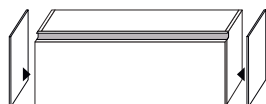

#### P 45

Pannelli terminali - OBBLIGATORI  
Terminal panels - REQUIRED  
Panueaux de finition latéral - OBLIGATOIRES  
Terminal Panele - NÖTIG

L	F1	F2	F3
1 GGUFIN10			

#### P 51,5

L	F1	F2	F3
1 GGUFIN40			

#### H 55,5

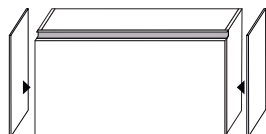

#### P 45

Pannelli terminali - OBBLIGATORI  
Terminal panels - REQUIRED  
Panueaux de finition latéral - OBLIGATOIRES  
Terminal Panele - NÖTIG

L	F1	F2	F3
1 GGUFIN15			

#### P 51,5

L	F1	F2	F3
1 GGUFIN45			



Misure in cm  
Measures in cm  
Mesures en cm  
Maße in cm

**F1** Laccato opaco  
Matt lacquered  
Laqué mat  
Matt lackiert

**F2** Laccato lucido  
Glossy lacquered  
Laqué brillant  
Hochglanz lackiert

**F3** Nobilitati  
Veneer wood  
Placage bois  
Beschichtetes Holz

**F4** Arock®  
Arock®  
Arock®

**F5** abitat / vogue  
abitat / vogue  
abitat / vogue  
abitat / vogue



# Basi Units

# Meubles bas Unterschränke

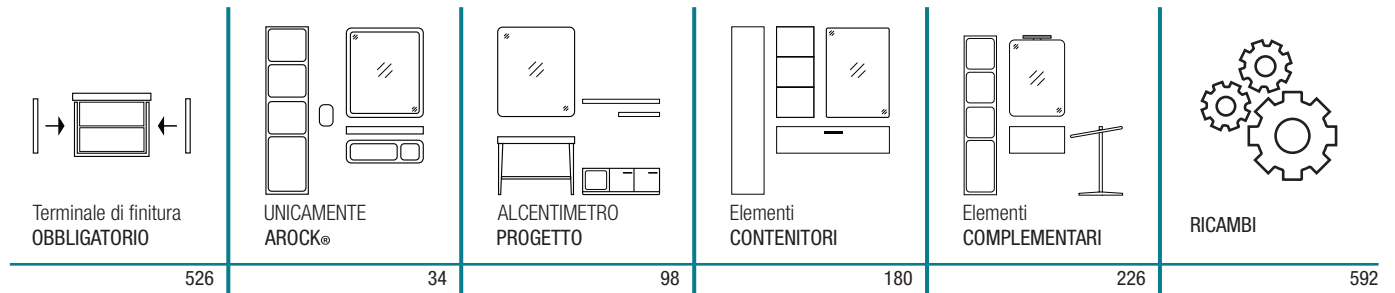

## H 37



## P 45

Base portlavabo • 1 cassetto chiusura ammortizzata • sifone incl.  
Vanity unit • 1 soft-closing pull-out • siphon incl.  
Meuble sous vasque • 1 tiroir amorti • siphon incl.  
Waschtischunterschrank • 1 Soft-Closing Schublade • Siphon inkl.

L		F1	F2	F3
54	GGL05404			
63	GGL06304			
72	GGL07204			
81	GGL08104			
90	GGL09004			
108	GGL10804			

## P 51,5

L		F1	F2	F3
54	GGM05404			
63	GGM06304			
72	GGM07204			
81	GGM08104			
90	GGM09004			
108	GGM10804			

## H 37

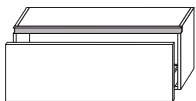

## P 45

Base laterale • 1 cassetto chiusura ammortizzata  
Side unit • 1 soft-closing pull-out  
Meuble bas latéral • 1 tiroir amorti  
Seitenschrank • 1 Soft-Closing Schublade

L		F1	F2	F3
27	GGG02704			
36	GGG03604			
54	GGG05404			
63	GGG06304			
72	GGG07204			
81	GGG08104			
90	GGG09004			
108	GGG10804			

## P 51,5

L		F1	F2	F3
27	GGJ02704			
36	GGJ03604			
54	GGJ05404			
63	GGJ06304			
72	GGJ07204			
81	GGJ08104			
90	GGJ09004			
108	GGJ10804			

## H 55,5

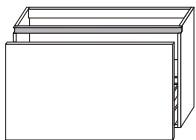

## P 45

Base portlavabo • 1 cassetto chiusura ammortizzata + 1 ripiano • sifone incl.  
Vanity unit • 1 soft-closing pull-out + 1 shelf • siphon incl.  
Meuble sous vasque • 1 tiroir amorti + 1 étagère • siphon incl.  
Waschtischunterschrank • 1 Soft-Closing Schublade + 1 Regal • Siphon inkl.

L		F1	F2	F3
54	GGL05406			
63	GGL06306			
72	GGL07206			
81	GGL08106			
90	GGL09006			
108	GGL10806			

## P 51,5

L		F1	F2	F3
54	GGM05406			
63	GGM06306			
72	GGM07206			
81	GGM08106			
90	GGM09006			
108	GGM10806			

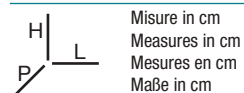

Misure in cm  
Measures in cm  
Mesures en cm  
Maße in cm

**F1** Laccato opaco  
Matt lacquered  
Laqué mat  
Matt lackiert

**F2** Laccato lucido  
Glossy lacquered  
Laqué brillant  
Hochglanz lackiert

**F3** Nobilitati  
Veneer wood  
Placage bois  
Beschichtetes Holz

**F4** Arock®  
Arock®  
Arock®  
Arock®

**F5** abitat / vogue  
abitat / vogue  
abitat / vogue  
abitat / vogue

## Basi Units

## Meubles bas Unterschränke

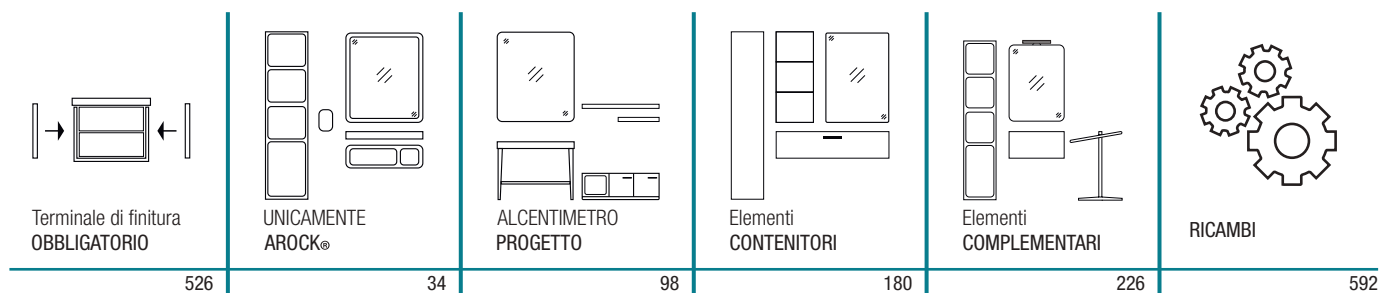

### H 55,5

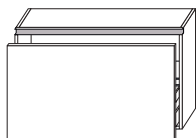

### P 45

Base laterale • 1 cassetto chiusura ammortizzata + 1 ripiano  
Side unit • 1 soft-closing pull-out + 1 shelf  
Meuble bas latéral • 1 tiroir amorti + 1 étagère  
Seitenschrank • 1 Soft-Closing Schublade + 1 Regal

L		F1	F2	F3
27	GGG02706			
36	GGG03606			
54	GGG05406			
63	GGG06306			
72	GGG07206			
81	GGG08106			
90	GGG09006			
108	GGG10806			

### P 51,5

L		F1	F2	F3
27	GGJ02706			
36	GGJ03606			
54	GGJ05406			
63	GGJ06306			
72	GGJ07206			
81	GGJ08106			
90	GGJ09006			
108	GGJ10806			

### H 55,5

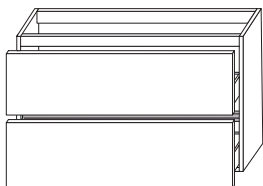

### P 45

Base portalavabo • 1 cassetto chiusura ammortizzata • sifone incl.  
Vanity unit • 1 soft-closing pull-out • siphon incl.  
Meuble sous vasque • 1 tiroir amorti • siphon incl.  
Waschtischunterschrank • 1 Soft-Closing Schublade • Siphon inkl.

L		F1	F2	F3
54	GGL05442			
63	GGL06342			
72	GGL07242			
81	GGL08142			
90	GGL09042			
108	GGL10842			
126	GGL12642			

### P 51,5

L		F1	F2	F3
54	GGM05442			
63	GGM06342			
72	GGM07242			
81	GGM08142			
90	GGM09042			
108	GGM10842			
126	GGM12642			

### H 55,5

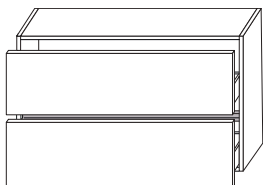

### P 45

Base laterale • 2 cassetti chiusura ammortizzata  
Side unit • 2 soft-closing pull-out  
Meuble bas latéral • 2 tiroirs amortis  
Seitenschrank • 2 Soft-Closing Schubläden

L		F1	F2	F3
27	GGG02742			
36	GGG03642			
54	GGG05442			
63	GGG06342			
72	GGG07242			
81	GGG08142			
90	GGG09042			
108	GGG10842			
126	GGG12642			

### P 51,5

L		F1	F2	F3
27	GGJ02742			
36	GGJ03642			
54	GGJ05442			
63	GGJ06342			
72	GGJ07242			
81	GGJ08142			
90	GGJ09042			
108	GGJ10842			
126	GGJ12642			

H  
L  
P

Misure in cm  
Measures in cm  
Mesures en cm  
Maße in cm

**F1** Laccato opaco  
Matt lacquered  
Laqué mat  
Matt lackiert

**F2** Laccato lucido  
Glossy lacquered  
Laqué brillant  
Hochglanz lackiert



**F3** Nobilitati  
Veneer wood  
Placage bois  
Beschichtetes Holz

**F4** Arock®  
Arock®  
Arock®  
Arock®

**F5** abitat / vogue  
abitat / vogue  
abitat / vogue  
abitat / vogue

## Basi Units

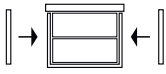
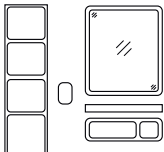
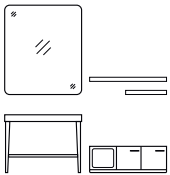
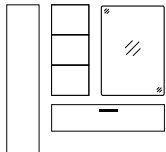
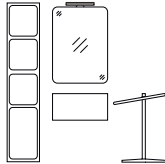
## Meubles bas Unterschränke

					
Terminale di finitura OBBLIGATORIO	UNICAMENTE AROCK®	ALCENTIMETRO PROGETTO	Elementi CONTENITORI	Elementi COMPLEMENTARI	RICAMBI
526	34	98	180	226	592

### H 55,5

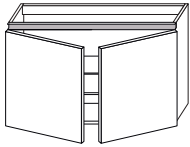

### P 45

Base portalavabo • 2 ante chiusura ammortizzata + 1 ripiano • sifone incl.  
Vanity unit • 2 soft-closing doors + 1 shelf • siphon incl.  
Meuble sous vasque • 2 portes amorties + 1 étagère • siphon incl.  
Waschtischunterschrank • 2 Türen + 1 Regal • Siphon inkl.

L		F1	F2	F3
54	GGL05412			
72	GGL07212			
90	GGL09012			
108	GGL10812			

### P 51,5

L		F1	F2	F3
54	GGM05412			
72	GGM07212			
90	GGM09012			
108	GGM10812			

### H 55,5

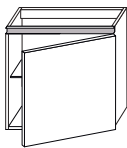

### P 45

Base portalavabo dx • 1 anta chiusura ammortizzata + 1 ripiano • sifone incl.  
Vanity unit • 1 soft-closing door + 1 shelf • siphon incl.  
Meuble sous vasque • 1 porte amorti + 1 étagère • siphon incl.  
Waschtischunterschrank • 1 Tür + 1 Regal • Siphon inkl.

L		F1	F2	F3
54	GGL05410			

### P 51,5

L		F1	F2	F3
54	GGM05410			

### H 55,5

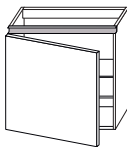

### P 45

Base portalavabo sx • 1 anta chiusura ammortizzata + 1 ripiano • sifone incl.  
Vanity unit • 1 soft-closing door + 1 shelf • siphon incl.  
Meuble sous vasque • 1 porte amorti + 1 étagère • siphon incl.  
Waschtischunterschrank • 1 Tür + 1 Regal • Siphon inkl.

L		F1	F2	F3
54	GGL05411			

### P 51,5

L		F1	F2	F3
54	GGM05411			

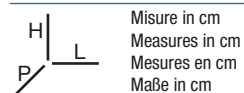

Misure in cm  
Measures in cm  
Mesures en cm  
Maße in cm

**F1** Laccato opaco  
Matt lacquered  
Laqué mat  
Matt lackiert

**F2** Laccato lucido  
Glossy lacquered  
Laqué brillant  
Hochglanz lackiert

**F3** Nobilitati  
Veneer wood  
Placage bois  
Beschichtetes Holz

**F4** Arock®  
Arock®  
Arock®  
Arock®

**F5** abitat / vogue  
abitat / vogue  
abitat / vogue  
abitat / vogue

# Basi Units

# Meubles bas Unterschränke

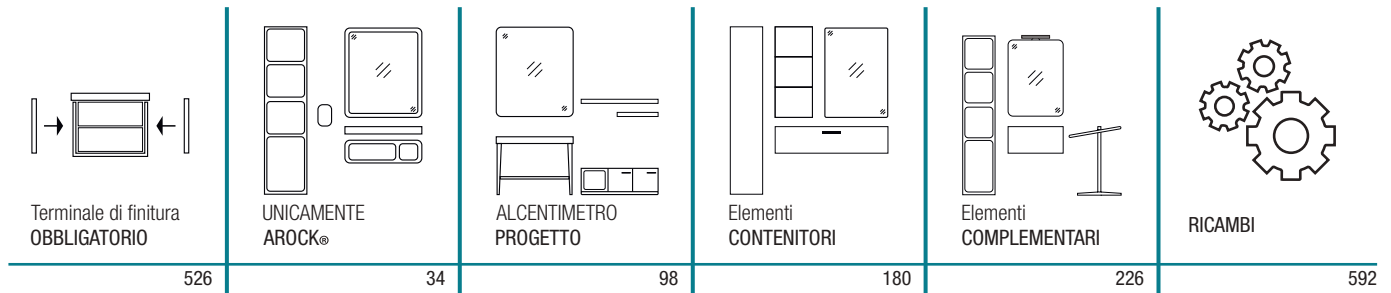

## H 55,5

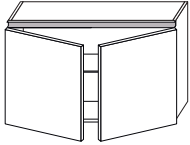

## P 45

Base laterale • 2 ante chiusura ammortizzata + 1 ripiano  
Side unit • 2 soft-closing doors + 1 shelf  
Meuble bas latéral • 2 portes amorties + 1 étagère  
Seitenschrank • 2 Türen + 1 Regal

L		F1	F2	F3
54	GGB05412			
72	GGB07212			
90	GGB09012			
108	GGB10812			

## P 51,5

L		F1	F2	F3
54	GGD05412			
72	GGD07212			
90	GGD09012			
108	GGD10812			

## H 55,5

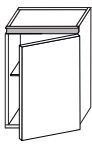

## P 45

Base laterale dx • 1 anta chiusura ammortizzata + 1 ripiano  
Side unit • 1 soft-closing door + 1 shelf  
Meuble bas latéral • 1 porte amortie + 1 étagère  
Seitenschrank • 1 Tür + 1 Regal

L		F1	F2	F3
27	GGB02710			
36	GGB03610			
54	GGB05410			

## P 51,5

L		F1	F2	F3
27	GGD02710			
36	GGD03610			
54	GGD05410			

## H 55,5



## P 45

Base laterale sx • 1 anta chiusura ammortizzata + 1 ripiano  
Side unit • 1 soft-closing door + 1 shelf  
Meuble bas latéral • 1 porte amortie + 1 étagère  
Seitenschrank • 1 Tür + 1 Regal

L		F1	F2	F3
27	GGB02711			
36	GGB03611			
54	GGB05411			

## P 51,5

L		F1	F2	F3
27	GGD02711			
36	GGD03611			
54	GGD05411			



Misure in cm  
Measures in cm  
Mesures en cm  
Maße in cm

**F1** Laccato opaco  
Matt lacquered  
Laqué mat  
Matt lackiert

**F2** Laccato lucido  
Glossy lacquered  
Laqué brillant  
Hochglanz lackiert

**F3** Nobilitati  
Veneer wood  
Placage bois  
Beschichtetes Holz

**F4** Arock®  
Arock®  
Arock®  
Arock®

**F5** abitat / vogue  
abitat / vogue  
abitat / vogue  
abitat / vogue





Il Taj Mahal è un mausoleo situato ad Agra nell'India Settentrionale costruito nel 1632 dall'imperatore in memoria dell'amata moglie, da sempre considerato una delle più notevoli bellezze dell'architettura islamica in India. Dal 1983 compreso nella lista dei patrimoni dell'umanità dall'UNESCO e dal 2007 inserito fra le Nuove Sette Meraviglie del Mondo





Taj Mahal is a mausoleum located in Agra, Northern India. In 1632, it was built by the Emperor, in memory of his wife. Since ever, Taj Mahal has been considered one of the most remarkable beauty of the Islamic architecture in India. Since 1983, Taj Mahal has been included in the heritage of the humanity's list by UNESCO. In 2007, it was proclaimed one of the Modern World's Seven Wonders





MOBILI LAVANDERIA

AUDACE



## A U D A C E

è la proposta costruttiva che TDA dedica alla zona lavanderia nelle profondità 50 e 65

misure adattabili, forme originali, funzioni pratiche, finiture piacevoli e materiali innovativi sono pensati per garantire il comfort nelle azioni della quotidianità con particolare attenzione al fattore estetico

un sistema completo di elementi pratici, disponibili per migliorare grandi e piccoli spazi

c'est la proposition dédiée à la buanderie en profondeurs de 50 et 65 centimètres

tailles adaptables, formes originales, fonctions pratiques, finitions agréables et matériaux innovants conçus pour garantir le confort dans les actions quotidiennes

un système complete d'éléments pratiques pour améliorer les grands et les petits espaces



is the constructive proposal that TDA dedicates to the laundry areas with the double depths 50 - 65

adaptable sizes, unique shapes, practical functions, pleasant finishes, and innovative materials are designed to ensure comfort in everyday activities with a focus on aesthetics

a complete system of practical elements improving large and small spaces

dies ist der Vorschlag für Möbel der Wäscherei in den Tiefen von 50 und 65 cm

anpassbare Größen, originelle Formen, praktische Funktionen, angenehme Oberflächen und innovative Materialien, die den Komfort bei alltäglichen Aktivitäten garantieren

ein komplettes System praktischer Elemente zur Aufwertung großer und kleiner Räume



**A** piano / top / plan / Platte

<b>TIPOLOGIE:</b> filopiano lavabo integrato <b>PROFONDITÀ:</b> 50-65 cm <b>FINITURE:</b> CASTMARBLE Bianco OPACO/LUCIDO TECNORIL Bianco	<b>TYPES:</b> integrated plan washbasin <b>DEPTH:</b> 50-65 cm <b>FINISHES:</b> CASTMARBLE White MATT/GLOSSY - TECNORIL White	<b>TIPOLOGIES:</b> lavabo intégré au plan <b>PROFONDEUR:</b> 50-65 cm <b>FINITIONS:</b> CASTMARBLE Blanc MAT/BRILLANT - TECNORIL Blanc	<b>TIPOLOGIEN:</b> integriertes Waschbecken <b>TIEFE:</b> 50-65 cm <b>AUSFÜHRUNGEN:</b> CASTMARBLE Weiß MATT/HOCH- GLANZ - TECNORIL Weiß
per lavatoio sopra piano da incasso <b>PROFONDITÀ:</b> 65 cm <b>FINITURE:</b> ceramica Bianco: SHAAK - DOBBY - PANSY CASTMARBLE Bianco: PIEL	for recessed washbasin <b>DEPTH:</b> 65 cm <b>FINISHES:</b> ceramic White: SHAAK - DOBBY - PANSY CASTMARBLE White: PIEL	pour lavoire encastré surélevé <b>PROFONDEUR:</b> 65 cm <b>FINITIONS:</b> ceramique Blanc: SHAAK - DOBBY - PANSY CASTMARBLE Blanc: PIEL	für Halbeinbau-Washbecken <b>TIEFE:</b> 65 cm <b>AUSFÜHRUNGEN:</b> Keramik Weiß: SHAAK - DOBBY - PANSY CASTMARBLE Weiß: PIEL

**B** contenitore / interior configuration / configuration intérieure / Innenausstattung

realizzato in pannelli di particelle di legno di spessore 18 mm, idrofughi, nobilitato con carta melaminica colore URBAN. Bordi in ABS in tinta. Cassetto montato su guide GRASS® ad estrazione totale con sponde laterali in metallo verniciato colore URBAN. Fondo e schienale nella finitura del contenitore Zoccolo H 12 cm in PVC <b>ALTEZZA:</b> 56-76-88 cm <b>PROFONDITÀ:</b> 50-65 cm <b>LARGHEZZA:</b> 35-45-50-60-70-90 cm	made of water repellent panels of 18 mm thick wood particles, covered with Nobilitato URBAN color. Matching ABS edges Drawer mounted on full extension GRASS® runners with URBAN color painted metal sides. Bottom and back in the finish of the container Toe-kick H 12 cm in PVC <b>HEIGHT:</b> 56-76-88 cm <b>DEPTH:</b> 50-65 cm <b>WIDTH:</b> 35-45-50-60-70-90 cm	en panneaux hydrofuges en particules de bois de 18 mm d'épaisseur. Recouvert de papier mélaminé couleur URBAN. Bords ABS de la même couleur tiroir monté sur coulisses GRASS® pleine extension avec côtés en métal peint couleur URBAN. Fond et retour dans la finition du intérieur Socle H 12 cm en PVC <b>HAUTEUR:</b> 56-76-88 cm <b>PROFONDEUR:</b> 50-65 cm <b>LARGEUR:</b> 35-45-50-60-70-90 cm	in wasserabweisenden Platten aus 18 mm starken Holzpartikeln. Farbmelaminpapier und ABS Kanten der gleichen Farbe Schublade montiert auf GRASS® Vollauszügen mit URBAN-farbig lackierten Metallseiten. Boden und Rückseite im Abgang des Behälters Sockel H 12 cm aus PVC <b>HÖHE:</b> 56-76-88 cm <b>TIEFE:</b> 50-65 cm <b>BREITE:</b> 35-45-50-60-70-90 cm
---	--	--	--

**C** frontali / front panels / tiroirs / Schublade

realizzato in pannelli di particelle di legno idrofugo nobilitato con carta melaminica <b>SPESSORE:</b> 1,8 cm <b>FINITURE:</b> Laccato OPACO/LUCIDO 48 colori.02 - Nobilitato LEGNO	made of water repellent panels of wood particles <b>THICKNESS:</b> 1,8 cm <b>FINISHES:</b> MATT/GLOSSY Lacquered 48 colori.02 - Nobilitato LEGNO	en panneaux hydrofuges en particules de bois recouvert de papier mélaminé <b>ÉPAISSEUR:</b> 1,8 cm <b>FINITIONS:</b> Laqué MAT/BRILLANT en 48 colori.02 - Nobilitato LEGNO	aus wasserabweisenden Spanplatten, veredelt mit Melaminpapier <b>DICKE:</b> 1,8 cm <b>OBERFLÄCHEN:</b> MATT/HOCHGLANZ Lack aus 48 colori.02 - Nobilitato LEGNO
---	--	--	---

**D** apertura / opening system / système d'ouverture / Öffnungssystem

maniglia modello FONT L 16/32 cm installazione su ante e cassetti in posizione predefinita <b>FINITURE:</b> cromo lucido	handle FONT L 16/32 cm pre-defined installation on doors and drawers <b>FINISHES:</b> cromo lucido	poignée FONT L 16/32 cm installation définie sur portes et tiroirs <b>FINITIONS:</b> cromo lucido	Griff FONT L 16 /32 cm an Türen und Schbladen vormontiert <b>OBERFLÄCHEN:</b> cromo lucido
---	---	---	--

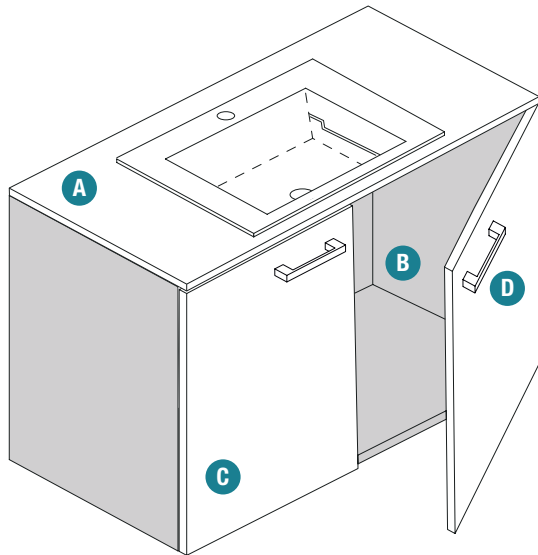

1 anta o 2 ante  
 1 door or 2 doors  
 1 porte ou 2 portes  
 1 Tür oder 2 Türen

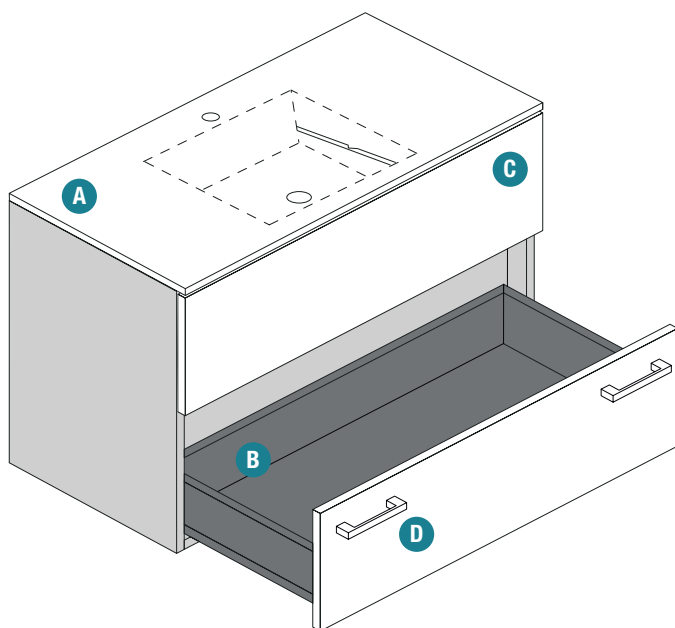

frontale fisso + frontale estraibile con cassetto  
 fixed front + 1 removable front with drawer  
 fixe façade + 1 façade amovible avec tiroir  
 fest Fassade + 1 Schublade



**Nobilitato LEGNO**

pannello di particelle di legno spessore 18 mm idrofugo a basso contenuto di formaldeide nobilitato interno ed esterno con carta melaminica in finitura LEGNO riprodotto ad alta fedeltà; bordo in ABS in finitura

high pressure layered laminate, a perfect and strong imitation of the natural wooden surface

stratifiés décoratifs haute pression. Plaques à base de résines thermoscurcissables appelées stratifiés

Hochdruckmehrschichtlaminat mit einer dreidimensionalen Erscheinung

**laccato OPACO / LUCIDO  
MATT / GLOSSY lacquered**

pannello di particelle di legno, idrofugo, a basso contenuto di formaldeide, verniciato con resine poliuretatiche pigmentate opache o lucide

wood particles panel 18 mm with low formaldehyde content, painted with polyurethane resins

**laqué MAT / BRILLANT  
MATT / HOCHGLANZ lackiert**

panneaux de particules de bois 18 mm à faible teneur en formaldéhyde, peint avec des résines de polyuréthane

Holzpartikelplatte 18 mm mit niedrigem Formaldehydgehalt, mit Polyurethanharzen lackiert

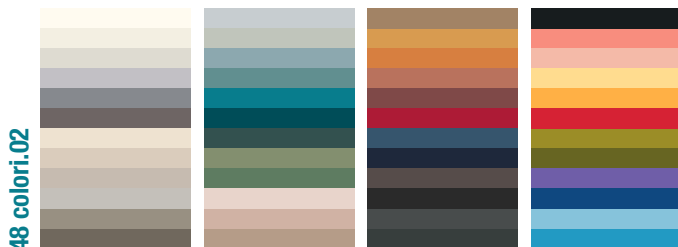

Maniglia FONT - L 16/32 cm

FINITURE:  
. cromo lucido



Handle FONT - L 16/32 cm

FINISHES:  
. cromo lucido

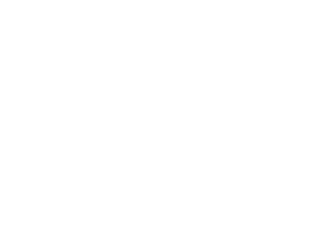

Poignée FONT - L 16/32 cm

FINITIONS:  
. cromo lucido



Griffe FONT - L 16/32 cm

OBERFLÄCHEN:  
. cromo lucido



## piani / tops / plans / \Platten



piano e piano d'arredo  
top for interior  
plan pour l'ameublement  
Platte fuer Einrichtung

## lavabi / washbasins / vasques / Becken



soprapiano da appoggio  
countertop basin  
lavabo á poser  
Aufsetzbecken

lavabo integrato  
integrated basin  
vasque intégrée  
integriertes Becken

	SP cm	P 50 cm	P 65 cm	
<b>HPL</b>	1			
<b>Nobilitato LEGNO / ALTATTO</b>	1,8			
<b>Nobilitato LEGNO</b>	3,6			
<b>Laccato OPACO / LUCIDO MATT / GLOSSY Lacquered Laqué MAT / BRILLANT MATT / HOCHGLANZ Lackiert</b>	1,8			
<b>GRES</b>	0,6 / 1,2			
<b>PIETRA NATURALE NATURAL STONE PIERRE NATURELLE NATURSTEIN</b>	2			
<b>SILESTONE</b>	1,2			
<b>CASTMARBLE</b>	1,2			
<b>TECNORIL</b>	1,2			

i colori qui riportati sono da considerarsi indicativi  
the colours can diverge from the reality  
la fidélité des couleurs peut être différent de la réalité  
bitte berücksichtigen Sie unsere Farbfächer zur Farbauswahl

## HPL - HIGH PRESSURE LAMINATE



laminato stratificato ad alta pressione costituito da fogli di cellulosa impregnati con resine fenoliche

high pressure layered laminate, a perfect and strong imitation of the natural wooden surface

stratifiés décoratifs haute pression. Plaques à base de résines thermodurcissables appelées stratifiés

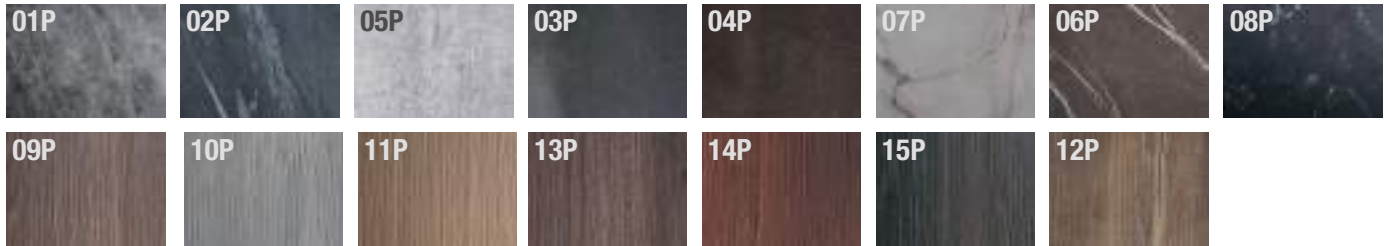
Hochdruckmehrschichtlaminat mit einer dreidimensionalen Erscheinung

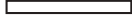

cod.	P	H	al cm lineare per linear cm au cm linéaire pro cm	+ prezzo foro lavabo + washbasin hole price + prix du trou pour vasque + Preis für Waschbeckenloch	
PSDL50PP PSDL65PP	50 65	1 1			
PSDL50LV PSDL65LV	50 65	1 1			

### Alzata / Wall top / Plan au mur / Platte an die Wand

cod.	sp.	H	al cm lineare / per linear cm / au cm linéaire / pro cm
PSD015AL	1	5 ÷ 15	
PSD040AL	1	16 ÷ 40	



## Nobilitato LEGNO / ALTATTO

pannello di particelle di legno spessore 18 mm idrofugo a basso contenuto di formaldeide nobilitato interno ed esterno con carta melaminica in finitura LEGNO riprodotto ad alta fedeltà o ALTATTO; bordo in ABS in finitura

high pressure layered laminate, a perfect and strong imitation of the natural wooden surface

stratifiés decoratifs haute pression. Plaques à base de résines thermodurcissables appelées stratifiés

Hochdruckmehrschichtlaminat mit einer dreidimensionalen Erscheinung

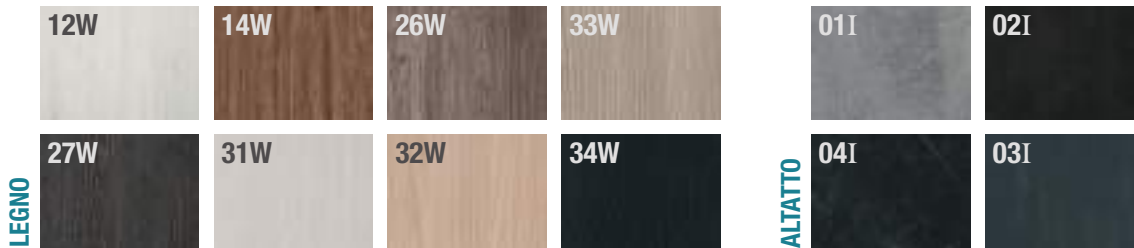

cod.	P	H	al cm lineare per linear cm au cm linéaire pro cm	+ prezzo foro lavabo + washbasin hole price + prix du trou pour vasque + Preis für Waschbeckenloch	
PSFL50PP PSFL65PP	50 65				
PSFL50LV PSFL65LV	50 65				

## Alzata / Wall top / Plan au mur / Platte an die Wand

cod.	sp.	H	al cm lineare / per linear cm / au cm linéaire / pro cm
PSF015AL	1,8	5 ÷ 15	
PSF040AL	1,8	16 ÷ 40	

**Laccato OPACO / LUCIDO**  
**MATT / GLOSSY Lacquered**
**Laqué MAT / BRILLANT**  
**MATT / HOCHGLANZ Lackiert**



pannello di particelle di legno, idrofugo, a basso contenuto di formaldeide, verniciato con resine poliuretatiche pigmentate opache o lucide

wood particles panel 18 mm with low formaldehyde content, painted with polyurethane resins

panneaux de particules the bois 18 mm à faible teneur en formaldéhide, peint avec des résines de polyuréthane

Holzpartikelplatte 18 mm mit niedrigem Formaldehydgehalt, mit Polyurethanharzen lackiert

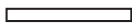

cod.	P	H	prezzo al cm lineare / per linear cm / au cm linéaire / pro cm		+ prezzo foro lavabo + washbasin hole price + prix du trou pour vasque + Preis für Waschbeckenloch	
			F1	F2		
PSFL50PP	50	1,8				
PSFL65PP	65	1,8				
PSFL50LV	50	1,8				
PSFL65LV	65	1,8				

**Alzata / Wall top / Plan au mur / Platte an die Wand**

cod.	sp.	H	al cm lineare / per linear cm / au cm linéaire / pro cm	
			F1	F2
PSF015AL	1,8	5 ÷ 15		
PSF040AL	1,8	16 ÷ 40		

## GRES

materiale ceramico compatto con superficie estremamente resistente alle macchie, ai graffi e agli urti. Antibatterico e igienico.

compact ceramic material with extremely resistant decorated and enamelled surface.

matériau céramique compact avec une surface décorée et émaillée extrêmement résistante.

kompakter Keramikwerkstoff mit extrem widerstandsfähiger dekoriertes und emailierter Oberfläche.

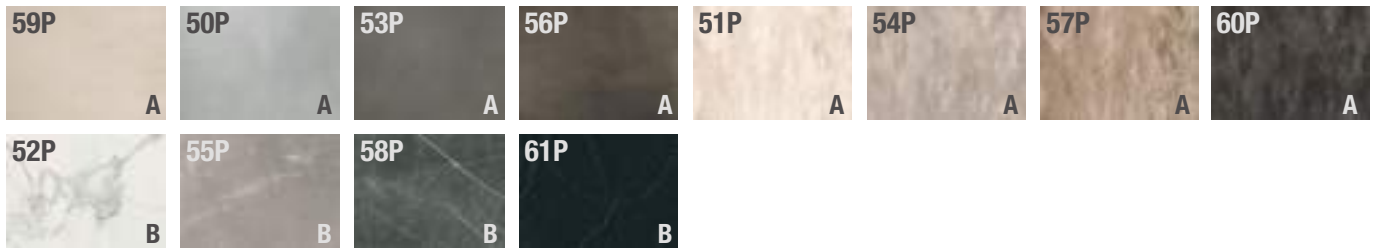

cod.	P	H	prezzo al cm lineare / per linear cm / au cm linéaire / pro cm			+ prezzo foro lavabo + washbasin hole price + prix du trou pour vasque + Preis für Waschbeckenloch
			A	B		
PSBL50PP	50	0,6				
PSBL65PP	65	0,6				
PSCL50PP	50	1,2				
PSCL65PP	65	1,2				

### Alzata / Wall top / Plan au mur / Platte an die Wand

cod.	sp.	H	al cm lineare / per linear cm / au cm linéaire / pro cm	
			A	B
PSB015AL	0,6	5 ÷ 15		
PSB040AL	0,6	16 ÷ 40		

**PIETRA NATURALE  
NATURAL STONE**



materiale reperibile in natura, resistente e durevole. Superficialmente trattato con apposito impregnante per ridurre l'assorbimento e meglio resistere alle macchie. Le diverse tonalità e disposizioni delle venature sono sinonimo di autenticità

strong and durable natural material. Treated to resist stains and absorption

matériau naturel solide et durable. Traité pour résister aux taches et à l'absorption

starkes und halbares natürliches Material. Behandelt, um Flecken und Absorption zu widerstehen

**PIERRE NATURELLE  
NATURSTEIN**

cod.	P	H	prezzo al cm lineare / per linear cm / au cm linéaire / pro cm				+ prezzo foro lavabo + washbasin hole price + prix du trou pour vasque + Preis für Waschbeckenloch	
			A	B	D			
PSAL50PP PSAL65PP	50 65	2 2						
PSAL50LV PSAL65LV	50 65	2 2						

**Alzata / Wall top / Plan au mur / Platte an die Wand**

cod.	sp.	H	al cm lineare / per linear cm / au cm linéaire / pro cm			
			A	B	D	
PSA015AL	2	5 ÷ 15				
PSA040AL	2	16 ÷ 40				

## SILESTONE



materiale composito costituito per il 94% da quarzo naturale, resine poliestere e pigmenti naturali. Estremamente duro e resistente. Antibatterico ed igienico. Altamente resistente alle macchie. Elevata resistenza a graffi e urti. Totalmente impermeabile ai liquidi

special material composed of quartz and natural pigments. Treated to resist stains and absorption

matériaux spécial composé the quartz et pigments naturels. Traité pour résister aux taches et à l'absorbition

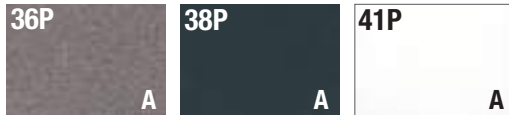
Spezialwerkstoff aus Quarz und natürlichen Pigmente. Behandelt, um Flecken und Absorption zu widerstehen

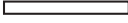

cod.	P	H	prezzo al cm lineare / per linear cm / au cm linéaire / pro cm		+ prezzo foro lavabo + washbasin hole price + prix du trou pour vasque + Preis für Waschbeckenloch	
			A			
PSAL50PP PSAL65PP	50 65	1,2 1,2				
PSAL50LV PSAL65LV	50 65	1,2 1,2				

### Alzata / Wall top / Plan au mur / Platte an die Wand

cod.	sp.	H	al cm lineare / per linear cm / au cm linéaire / pro cm	
			A	
PSA015AL	1,2	5 ÷ 15		
PSA040AL	1,2	16 ÷ 40		

## CASTMARBLE

materiale composito costituito da carbonato di calcio, magnesio e resina poliestere. La finitura superficiale e l'assenza di giunzioni lo rende resistente. Disponibile in finitura bianco opaco e bianco lucido spessore 1,2 cm



special material composed of carbonates, magnesium and polyhedral resins. the surface finish and the absence of joints makes it resistant

matériau spécial composé de alumine et résine acrylique. la finition de surface et l'absence de joints le rendent résistant

Spezialwerkstoff aus Aluminiumoxid und Acrylharz. die Oberflächenbeschaffenheit und das Fehlen von Gelenken macht es resistent

20P

21P

cod.	P	H	al cm lineare per linear cm au cm linéaire pro cm	+ prezzo vasca + basin price + prix pour la vasque + Preis des Beckens	+ prezzo foro lavatoio + washbasin hole price + prix du trou pour vasque + Preis für Waschbeckenloch	
PSML50PP PSML65PP	50 65	1,2 1,2				
PSML50LV PSML65LV	50 65	1,2 1,2				

### Alzata / Wall top / Plan au mur / Platte an die Wand

L min 25 cm / L max 210 cm

cod.	sp.	H	prezzo al cm lineare / per linear cm / au cm linéaire / pro cm <b>A</b>
PSM015AL	1,2	5 ÷ 15	
PSM040AL	1,2	16 ÷ 40	

**TECNORIL**



materiale composito costituito da allumina e resina acrilica. La finitura superficiale e l'assenza di giunzioni lo rende resistente e visivamente gradevole. Disponibile in finitura bianco opaco spessore 1,2 cm

special material composed of alumina and acrylic resin. the surface finish and the absence of joints makes it resistant

matériau spécial composé de carbonates et de résines polyester. la finition de surface et l'absence de joints le rendent résistant

Verbundwerkstoff aus extrem widerstandsfähigem Siliziumdioxid. extra leicht lackiert. die Farbe wird auf die Unterseite gesprüht

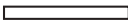
22P

cod.	P	H	al cm lineare per linear cm au cm linéaire pro cm	+ prezzo vasca + basin price + prix pour la vasque + Preis des Beckens	+ prezzo foro lavatoio + washbasin hole price + prix du trou pour vasque + Preis für Waschbeckenloch	
PSNL50PP PSNL65PP	50 65	1,2 1,2				
PSNL50LV PSNL65LV	50 65	1,2 1,2				

**Alzata / Wall top / Plan au mur / Platte an die Wand**

L min 25 cm / L max 210 cm

cod.	sp.	H	A	prezzo al cm lineare / per linear cm / au cm linéaire / pro cm
PSN015AL	1,2	5 ÷ 15		
PSN040AL	1,2	16 ÷ 40		







**SHAAK**

Lavatoio sopra piano da incasso in ceramica bianca  
 White ceramic recessed basin  
 Lavabo encastré surélevé en céramique blanche  
 Halbeinbaubecken aus weißer Keramik

**LATLVT03**  
**LATLVT04**  
**LATLVT05**

**PIEL**

Lavatoio sopra piano da incasso in CASTMARBLE bianco  
 White CASTMARBLE recessed basin  
 Lavabo encastré surélevé en CASTMARBLE blanche  
 Halbeinbaubecken aus weißer CASTMARBLE

**LATLVT02**

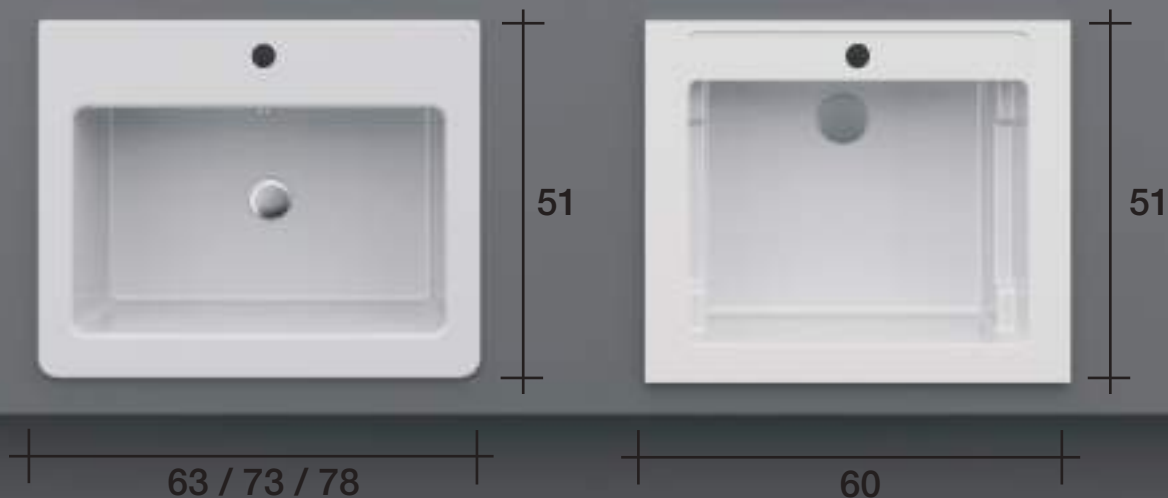

tavoletta opzionale in CASTMARBLE bianco  
 white CASTMARBLE washing board available  
 planche à laver blanche optional en CASTMARBLE  
 einem optionalen CASTMARBLE weißer Waschbrett

**LATLVT1**



provvisto di scarico troppopieno e foro rubinetto  
 with overflow system and tap hole  
 avec système de trop-plein et trou pour le robinet  
 mit Überlaufsystem und Armaturbohrung

kit piletta e sifone da ordinare separatamente  
 waste kit and siphon to be ordered separately  
 kit bonde d'évacuation et siphon à commander séparément  
 Ablauf Kit und Siphon müssen separat bestellt werden

provvisto di scarico troppopieno e foro rubinetto  
 with overflow system and tap hole  
 avec système de trop-plein et trou pour le robinet  
 mit Überlaufsystem und Armaturbohrung

kit piletta e sifone da ordinare separatamente  
 waste kit and siphon to be ordered separately  
 kit bonde d'évacuation et siphon à commander séparément  
 Ablauf Kit und Siphon müssen separat bestellt werden

## LAVATOI SOPRAPIANO DA INCASSO

## SHAAK



per installazione P 65  
 for installation D 65  
 pour l'installation P 65  
 für Installation T 65

su basi portalavabo o bancone min L 65/75/80 cm  
 washbasin unit or work plan min W 65/75/80 cm  
 meuble sous-vasque ou banc de travail min L 65/75/80 cm  
 Waschtischunterschrank oder Arbeitsplat min B 65/75/80 cm

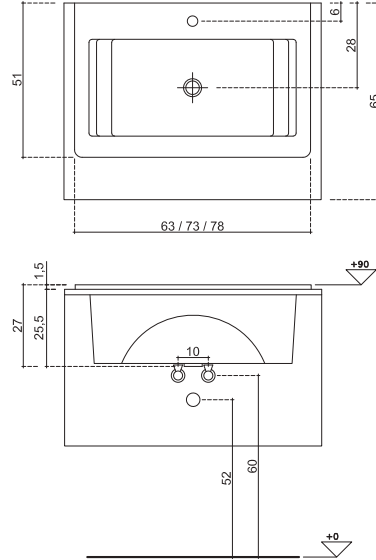

## PIEL



per installazione P 65  
 for installation D 65  
 pour l'installation P 65  
 für Installation T 65

su basi portalavabo o bancone min L 60 cm  
 washbasin unit or work plan min W 60 cm  
 meuble sous-vasque ou banc de travail min L 60 cm  
 Waschtischunterschrank oder Arbeitsplat min B 60 cm

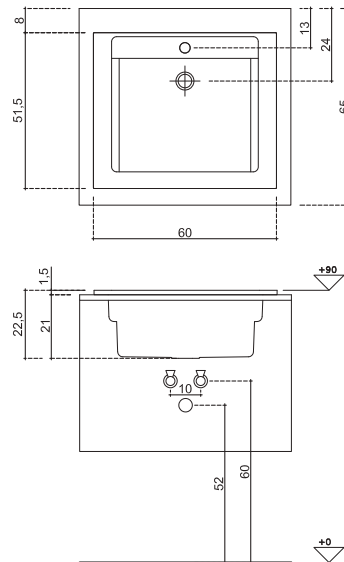

**DOBBY**

Lavatoio sopra piano da incasso in ceramica bianca  
 White ceramic recessed basin  
 Lavabo encastré surélevé en céramique blanche  
 Halbeinbaubecken aus weißer Keramik

**LATLVT08**

51

71

**PANSY**

Lavatoio sopra piano da incasso in ceramica bianca  
 White ceramic recessed basin  
 Lavabo encastré surélevé en céramique blanche  
 Halbeinbaubecken aus weißer Keramik

**LATLVT07**

51

61



provisto di scarico troppopieno e foro rubinetto  
 with overflow system and tap hole  
 avec système de trop-plein et trou pour le robinet  
 mit Überlaufsystem und Armaturbohrung

kit piletta e sifone da ordinare separatamente  
 waste kit and siphon to be ordered separately  
 kit bonde d'évacuation et siphon à commander séparément  
 Ablauf Kit und Siphon müssen separat bestellt werden

provisto di scarico troppopieno e foro rubinetto  
 with overflow system and tap hole  
 avec système de trop-plein et trou pour le robinet  
 mit Überlaufsystem und Armaturbohrung

kit piletta e sifone da ordinare separatamente  
 waste kit and siphon to be ordered separately  
 kit bonde d'évacuation et siphon à commander séparément  
 Ablauf Kit und Siphon müssen separat bestellt werden

## LAVATOI SOPRAPIANO DA INCASSO

## DOBBY



per installazione P 65  
for installation D 65  
pour l'installation P 65  
für Installation T 65

su basi portalavabo o bancone min L 73 cm  
washbasin unit or work plan min W 73 cm  
meuble sous-vasque ou banc de travail min L 73 cm  
Waschtischunterschrank oder Arbeitsplat min B 73 cm

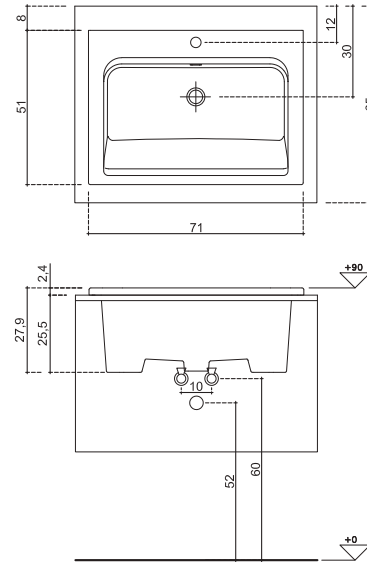

## PANSY



per installazione P 65  
for installation D 65  
pour l'installation P 65  
für Installation T 65

su basi portalavabo o bancone min L 63 cm  
washbasin unit or work plan min W 63 cm  
meuble sous-vasque ou banc de travail min L 63 cm  
Waschtischunterschrank oder Arbeitsplat min B 63 cm

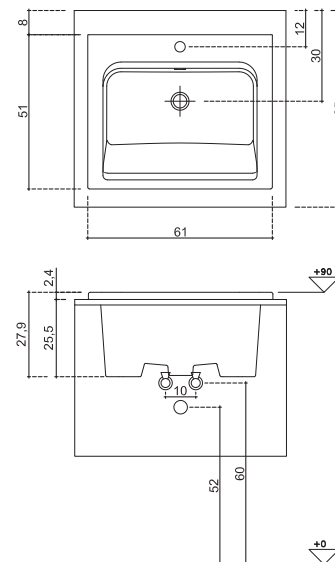

Filopiano lavabo integrato in CASTMARBLE e TECNORIL  
 CASTMARBLE and TECNORIL integrated plan washbasin  
 Vasque en plan intégrée CASTMARBLE et TECNORIL  
 Integrierte Waschtischplatte aus CASTMARBLE und TECNORIL

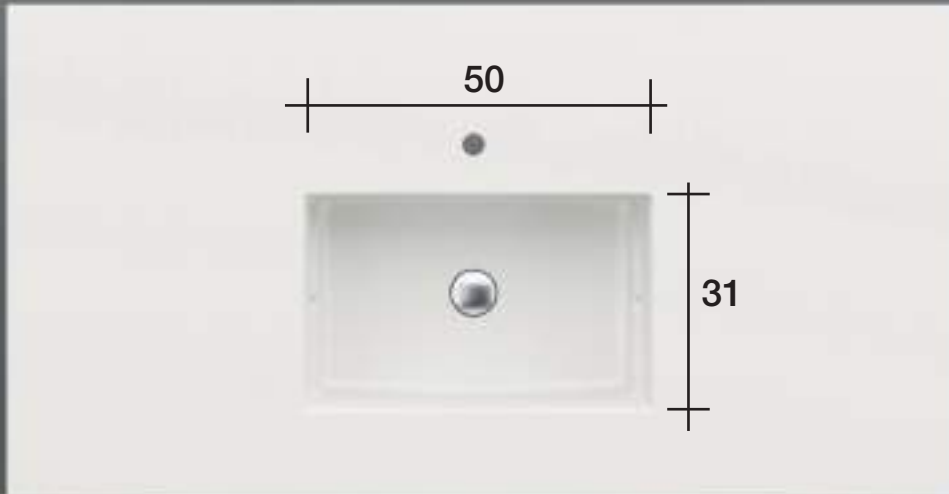

tavoletta opzionale in CASTMARBLE bianco  
 white CASTMARBLE washing board optional  
 planche à laver blanche optionnel en CASTMARBLE  
 einem optionalen CASTMARBLE weißer Waschbrett

### LATM50TA

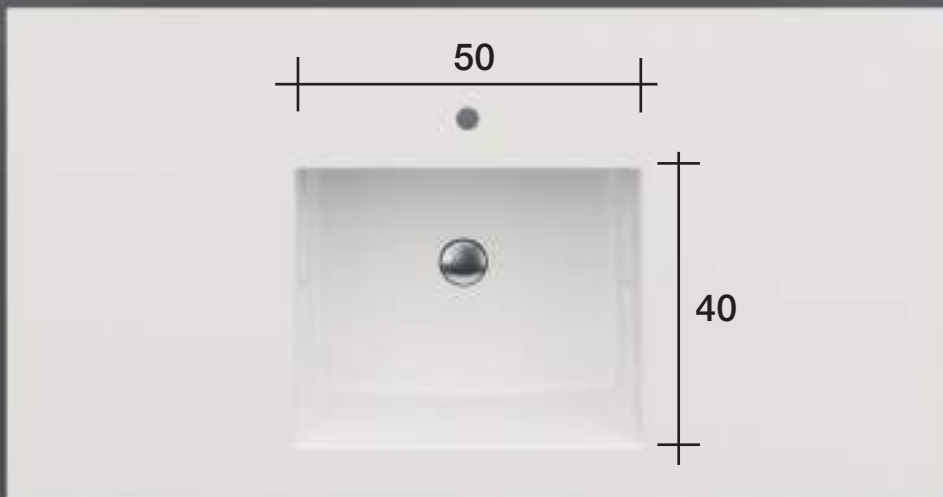

tavoletta opzionale in CASTMARBLE bianco  
 white CASTMARBLE washing board optional  
 planche à laver blanche optionnel en CASTMARBLE  
 einem optionalen CASTMARBLE weißer Waschbrett

### LATM65TA

foro rubinetto incl.  
 tap hole incl.  
 trou pour le robinet incl.  
 Armaturbohrung inkl.

non provvisto di scarico troppopieno  
 without overflow system  
 sans système de trop-plein  
 ohne Überlaufsystem

kit piletta e sifone da ordinare separatamente  
 waste kit and siphon to be ordered separately  
 kit bonde d'évacuation et siphon à commander séparément  
 Ablauf Kit und Siphon müssen separat bestellt werden

**P 50**

su basi portalavabo min L 60 cm  
 washbasin unit min W 60 cm  
 meuble sous-vasque min L 60 cm  
 Waschtischunterschrank min B 60 cm

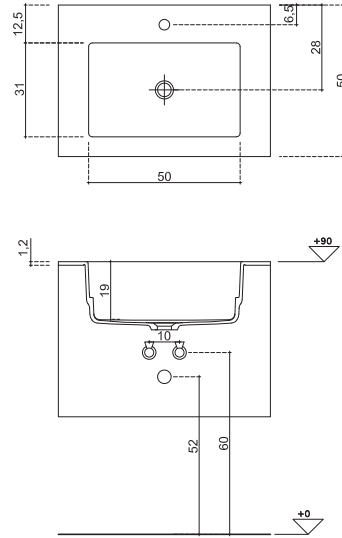
**P 65**

su basi portalavabo min L 60 cm  
 washbasin unit min W 60 cm  
 meuble sous-vasque min L 60 cm  
 Waschtischunterschrank min B 60 cm

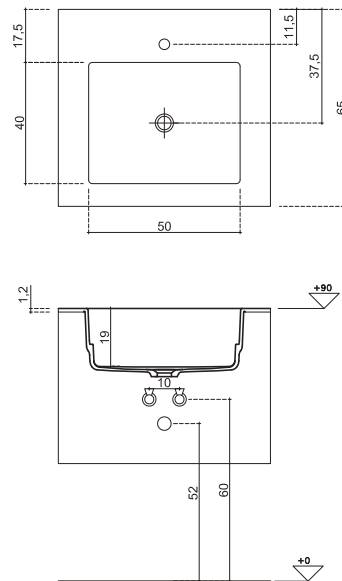

## CASTMARBLE

materiale composito costituito da carbonato di calcio, magnesio e resina poliestere. La finitura superficiale e l'assenza di giunzioni lo rende resistente. Disponibile in finitura bianco opaco e bianco lucido spessore 1,2 cm

special material composed of carbonates, magnesium and polyhedral resins. the surface finish and the absence of joints makes it resistant

matériau spécial composé de alumine et résine acrylique. la finition de surface et l'absence de joints le rendent résistant

Spezialwerkstoff aus Aluminiumoxid und Acrylharz. die Oberflächenbeschaffenheit und das Fehlen von Gelenken macht es resistent

lavabo integrato  
integrated washbasin  
vasque intégrée  
integriertes Becken



20P

21P

cod.	P	H	al cm lineare per linear cm au cm linéaire pro cm	+ prezzo vasca + basin price + prix pour la vasque + Preis des Beckens	+ prezzo foro lavatoio + washbasin hole price + prix du trou pour vasque + Preis für Waschbeckenloch	
PSML50IN	50	1,2				
PSML65IN	65	1,2				

## Alzata / Wall top / Plan au mur / Platte an die Wand

L min 25 cm / L max 210 cm

cod.	sp.	H	A	prezzo al cm lineare / per linear cm / au cm linéaire / pro cm
PSM015AL	1,2	5 ÷ 15		
PSM040AL	1,2	16 ÷ 40		



## TECNORIL

materiale composito costituito da allumina e resina acrilica. La finitura superficiale e l'assenza di giunzioni lo rende resistente e visivamente gradevole. Disponibile in finitura bianco opaco spessore 1,2 cm

special material composed of alumina and acrylic resin. the surface finish and the absence of joints makes it resistant

matériau spécial composé de carbonates et de résines polyester. la finition de surface et l'absence de joints le rendent résistant

Verbundwerkstoff aus extrem widerstandsfähigem Siliziumdioxid. extra leicht lackiert. die Farbe wird auf die Unterseite gesprüht

lavabo integrato  
integrated washbasin  
vasque intégrée  
integriertes Becken



22P

cod.	P	H	al cm lineare per linear cm au cm linéaire pro cm	+ prezzo vasca + basin price + prix pour la vasque + Preis des Beckens	+ prezzo foro lavatoio + washbasin hole price + prix du trou pour vasque + Preis für Waschbeckenloch	
PSNL50IN	50	1,2				
PSNL65IN	65	1,2				

### Alzata / Wall top / Plan au mur / Platte an die Wand

L min 25 cm / L max 210 cm

cod.	sp.	H	A	prezzo al cm lineare / per linear cm / au cm linéaire / pro cm
PSN015AL	1,2	5 ÷ 15		
PSN040AL	1,2	16 ÷ 40		

**Modularità**  
**Modularity**

**Modularité**  
**Modularität**

**basi portalavabo**  
**vanity units**  
**meubles sous-vasque**  
**Waschtischunterschänke**

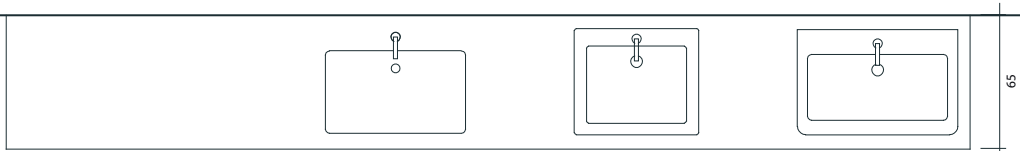
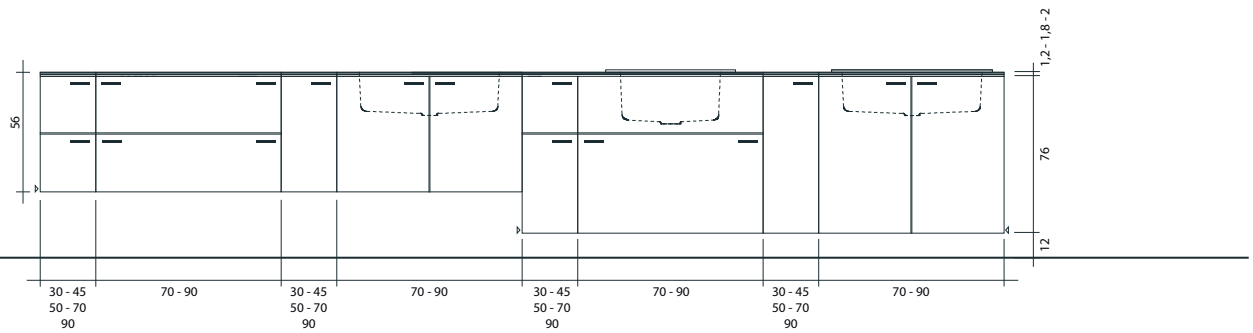

**basi portalavabo - zoccolo H 12 cm incluso**  
**vanity units - toe-kick H 12 incl.**  
**meubles sous-vasque - socle H 12 incl.**  
**Waschtischunterschänke - Sockel H 12 inkl.**

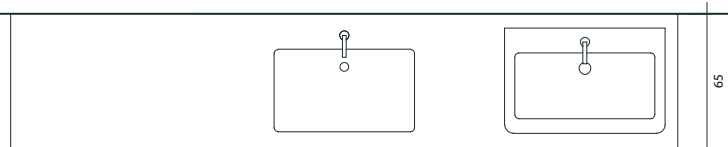
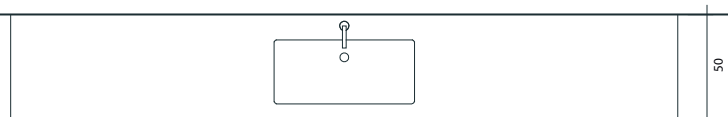
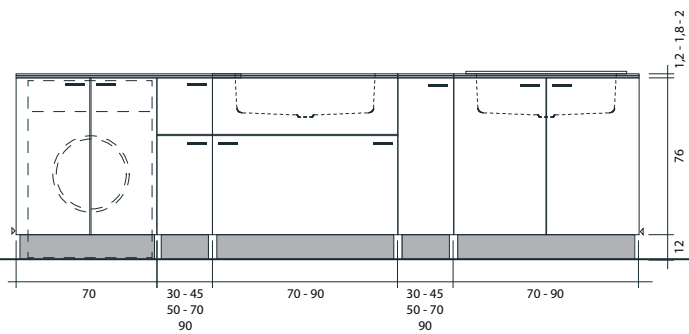

**basi portlavabo**  
**vanity units**  
**meubles sous-vasque**  
**Waschtischunterschänke**

L 70-90 cm

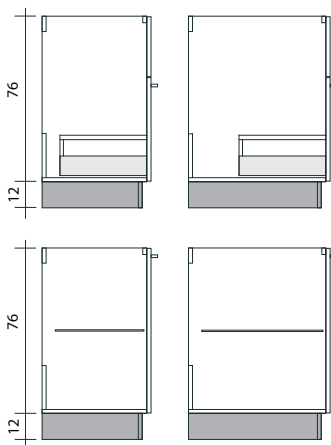
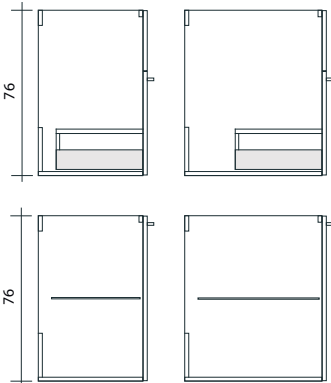
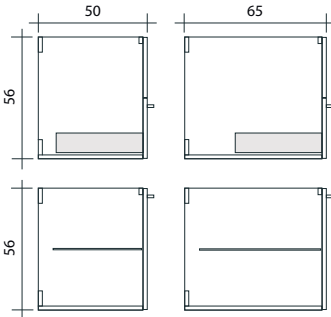

**basi laterali**  
**side units**  
**meubles bas latéraux**  
**Unterschänke**

L 35-45-50-70-90 cm

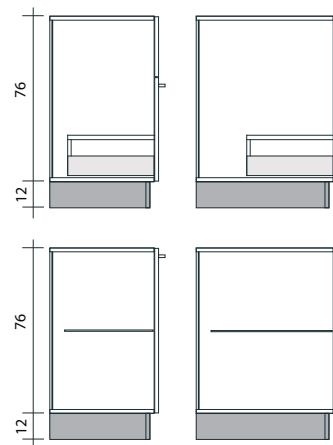
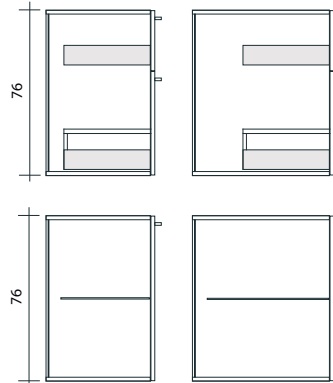
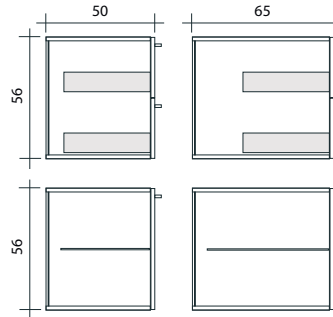

frontale fisso + frontale estraibile con cassetto / 2 frontali estraibili con cassetto  
 fixed front + 1 removable front with drawer / 2 removable fronts with drawer  
 fixe façade + 1 façade avec tiroir / 2 façades avec tiroir  
 1 Schublade / 2 Schubladen

1 anta o 2 ante chiusura ammortizzata + 1 ripiano  
 single door or double door, soft-closing + 1 shelf  
 1 porte ou 2 portes + 1 étagère  
 1 Tür oder 2 Türen + 1 Regal

frontale fisso + frontale estraibile con cassetto / 2 frontali estraibili con cassetto  
 fixed front + 1 removable front with drawer / 2 removable fronts with drawer  
 fixe façade + 1 façade avec tiroir / 2 façades avec tiroir  
 1 Schublade / 2 Schubladen

1 anta o 2 ante chiusura ammortizzata + 1 ripiano  
 single door or double door, soft-closing + 1 shelf  
 1 porte ou 2 portes + 1 étagère  
 1 Tür oder 2 Türen + 1 Regal

frontale fisso + frontale estraibile con cassetto / 2 frontali estraibili con cassetto  
 fixed front + 1 removable front with drawer / 2 removable fronts with drawer  
 fixe façade + 1 façade avec tiroir / 2 façades avec tiroir  
 1 Schublade / 2 Schubladen

1 anta o 2 ante chiusura ammortizzata + 1 ripiano  
 single door or double door, soft-closing + 1 shelf  
 1 porte ou 2 portes + 1 étagère  
 1 Tür oder 2 Türen + 1 Regal

Modularità  
Modularity

Modularité  
Modularität

elementi a giorno  
shelving unit  
éléments ouverts  
offenen Elementen

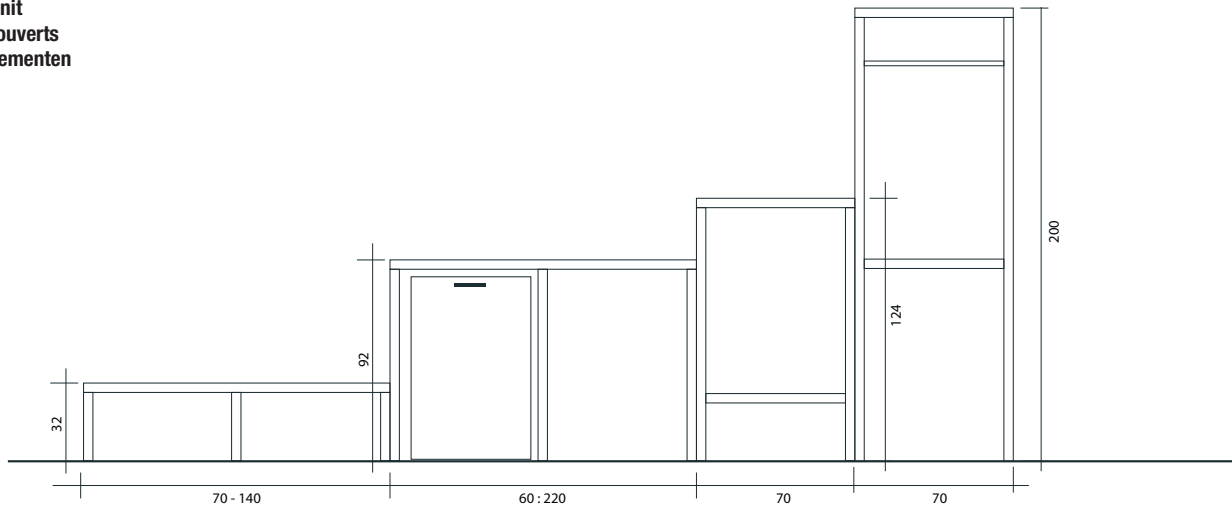

colonne attrezzate  
laundry tall cabinets  
armoires hautes sur pieds  
Hochschränke-stehend

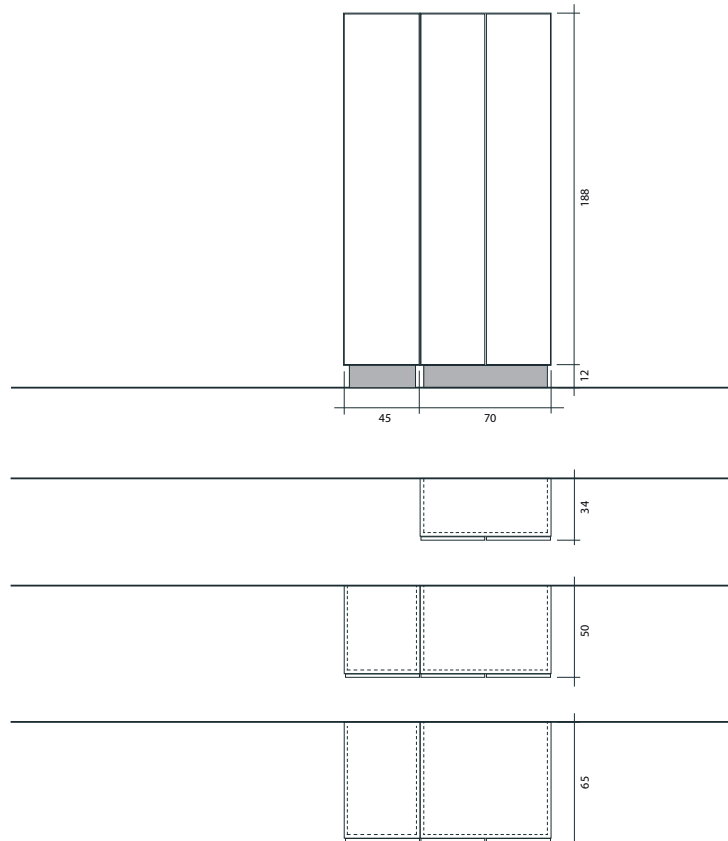

**carrello portabiancheria**  
**laundry trolley under basin**  
**chariot à linge sous vasque**  
**Rollcontainer unter Waschtisch für Arbeitsplat**

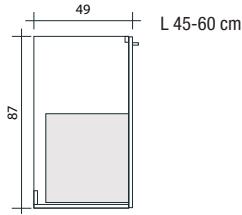

L 70-140 cm  
 panca / bench / banquette / Bank

L da 60 a 220 cm  
 bancone / work bench / banc de travail/  
 Arbeitsplat

L 70 cm  
 colonne a giorno / open columns / colonnes  
 ouvertes / offene Hochschränke

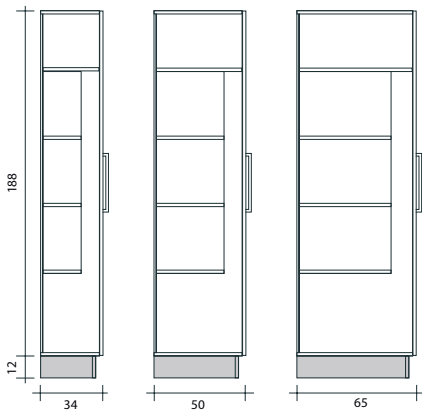
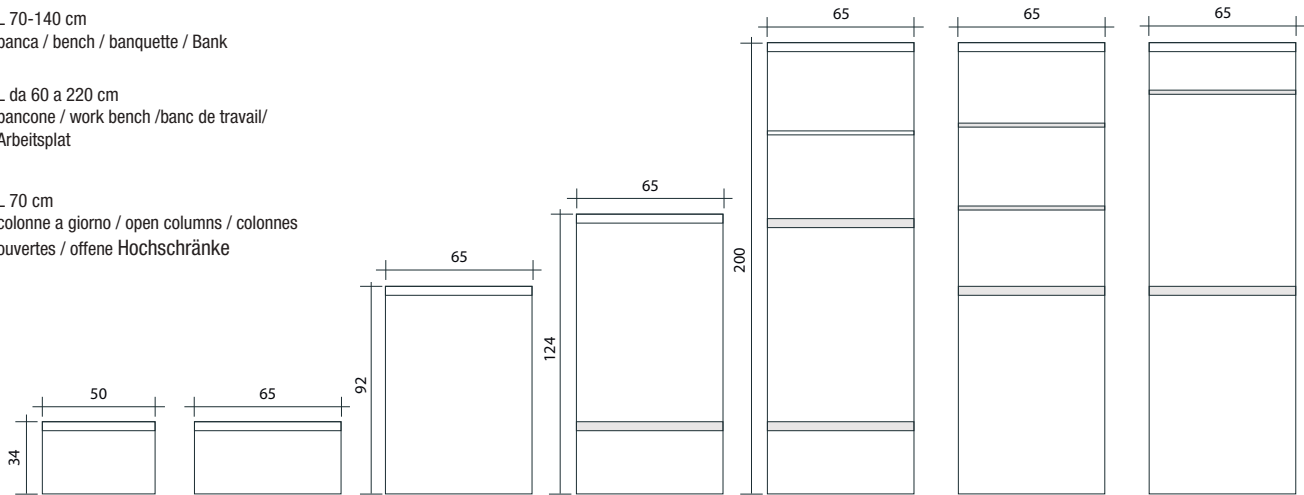

L 45 cm  
 1 anta  
 1 door  
 1 porte  
 1 Tür

L 70 cm  
 2 ante  
 2 doors  
 2 portes  
 2 Türen

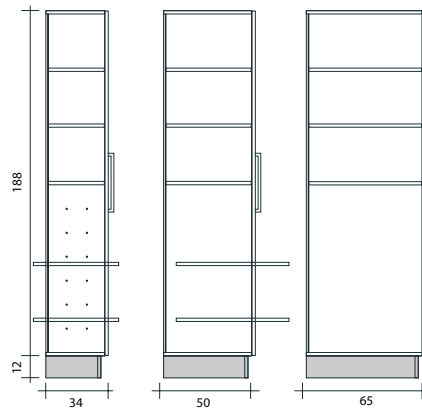

L 45 cm  
 1 anta  
 1 door  
 1 porte  
 1 Tür

L 70 cm  
 2 ante  
 2 doors  
 2 portes  
 2 Türen

Colonna a giorno per lavatrice  
 Washer tall unit  
 Armoire haute ouverte pour laveuse  
 Hochschrank für Waschmaschine

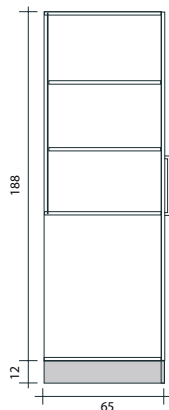

L 70 cm  
 2 ante  
 2 doors  
 2 portes  
 2 Türen

colonne per lavatrice e asciugatrice  
 Washer and dryer tall unit  
 Armoire haute ouverte pour laveuse  
 et sècheuse  
 Hochschrank für Waschmaschine und  
 Trockner

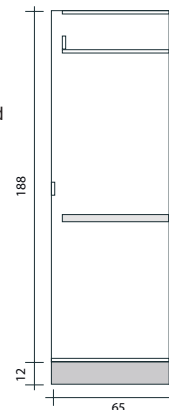

L 70 cm  
 2 ante  
 2 doors  
 2 portes  
 2 Türen









La Grande Muraglia, situata nell'odierna Cina, risulterebbe lunga 8.850 Km di cui 350 Km di trincee e circa 2.250 Km di difese naturali, con uno sviluppo complessivo di 21.196 Km misurandone tutte le ramificazioni. Dichiarata patrimonio dell'UNESCO nel 1987 e inserita nel 2007 fra le Sette Meraviglie del Mondo Moderno viene costruita a partire dal 215 a.C. per volere dell'imperatore, lo stesso a cui si deve il cosiddetto Esercito di Terracotta Xi'an



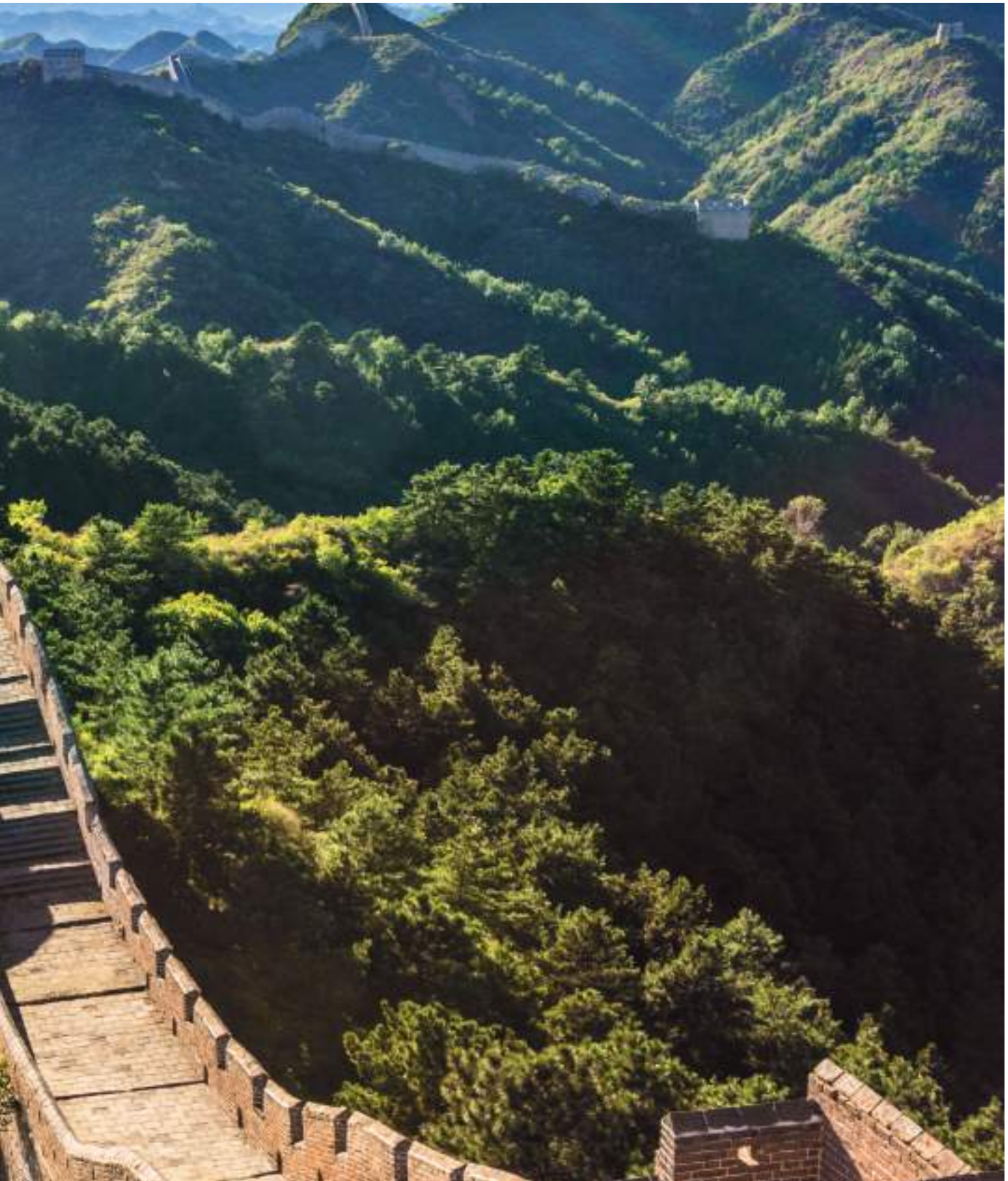



The Great Wall, located in today's China, is 8.850 km long, 350 km of which are dedicated to the trenches and 2.250 km of natural defenses, with a total length of 21.196 km including all its ramifications. In 1987, it was nominated heritage of the humanity by UNESCO and, in 2007, it was included in the Modern World's Seven Wonders. Following the order of the First Emperor of the Qin dynasty, in 215 b.C. the people of China started building the Wall. This Emperor is the same one that has created the Xi'an Terracotta Army

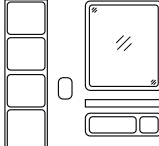
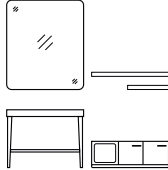
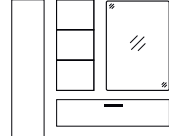
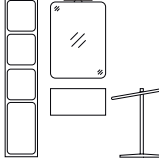

## Elementi a giorno Laundry units

## Éléments ouverts Offene Elemente

					
LAVATOI	UNICAMENTE AROCK®	ALCENTIMETRO PROGETTO	Elementi CONTENITORI	Elementi COMPLEMENTARI	RICAMBI
552	34	98	180	226	592

### H 32

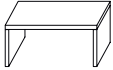

### P 50

Panca  
Bench  
Banquette  
Bank

L	F1	F2	F3
70 LAK03202			

### P 65

L	F1	F2	F3
70 LAK03232			

### H 32

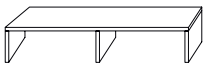

### P 50

Panca  
Bench  
Banquette  
Bank

L	F1	F2	F3
140 LAK03204			

### P 65

L	F1	F2	F3
140 LAK03234			

### H 92

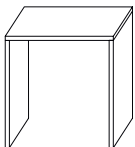

Bancone • a richiesta foro lavabo  
Work bench • hole for basin on demand  
Banc de travail • sur demande le découpe pour vasque  
Arbeitsplat • Abschnitt für Waschbecken auf Anfrage

### P 65

L	F1	F2	F3
60÷130 LAK13020			

H  
L  
P

Misure in cm  
Measures in cm  
Mesures en cm  
Maße in cm

**F1** Laccato opaco  
Matt lacquered  
Laqué mat  
Matt lackiert

**F2** Laccato lucido  
Glossy lacquered  
Laqué brillant  
Hochglanz lackiert



**F3** Nobilitati  
Veneer wood  
Placage bois  
Beschichtetes Holz

**F4** Arock®  
Arock®  
Arock®  
Arock®

**F5** abitat / vogue  
abibat / vogue  
abibat / vogue  
abibat / vogue

## Elementi a giorno Laundry units

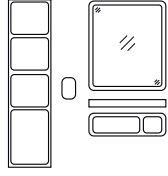
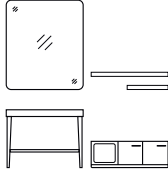
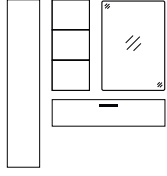
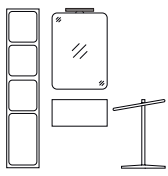
## Éléments ouverts Offene Elemente

					
LAVATOI	UNICAMENTE AROCK®	ALCENTIMETRO PROGETTO	Elementi CONTENTORI	Elementi COMPLEMENTARI	RICAMBI
552	34	98	180	226	592

### H 92

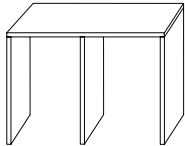

Bancone • a richiesta foro lavabo  
Work bench • hole for basin on demand  
Banc de travail • sur demande le découpe pour vasqu  
Arbeitsplat • Abschnitt für Waschbecken auf Anfrage

### P 65

L	F1	F2	F3
131÷180	LAK18022		

### H 92

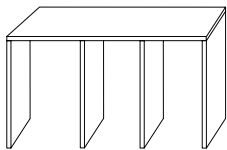

Bancone • a richiesta foro lavabo  
Work bench • hole for basin on demand  
Banc de travail • sur demande le découpe pour vasque  
Arbeitsplat • Abschnitt für Waschbecken auf Anfrage

### P 65

L	F1	F2	F3
181÷220	LAK22024		

### H 87

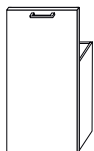

### P 49

Carrello portabiancheria sottolavabo  
Laundry trolley under basin  
Chariot à linge sous vasque  
Rollcontainer unter Waschtisch für Arbeitsplat

L	F1	F2	F3
45	LAU04502		
60	LAU06002		

H  
L  
P

Misure in cm  
Measures in cm  
Mesures en cm  
Maße in cm

**F1** Laccato opaco  
Matt lacquered  
Laqué mat  
Matt lackiert

**F2** Laccato lucido  
Glossy lacquered  
Laqué brillant  
Hochglanz lackiert



**F3** Nobilitati  
Veneer wood  
Placage bois  
Beschichtetes Holz

**F4** Arock®  
Arock®  
Arock®

**F5** abitat / vogue  
abitat / vogue  
abitat / vogue  
abitat / vogue

## Elementi a giorno Laundry units

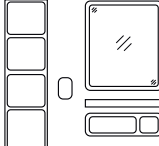
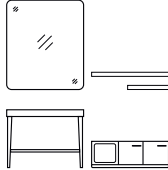
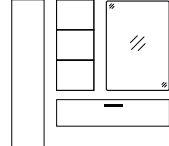
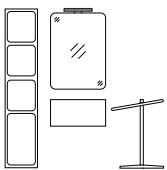
## Éléments ouverts Offene Elemente

					
LAVATOI	UNICAMENTE AROCK®	ALCENTIMETRO PROGETTO	Elementi CONTENITORI	Elementi COMPLEMENTARI	RICAMBI
552	34	98	180	226	592

### H 124

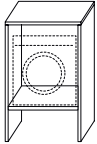

Colonna a giorno per lavatrice  
Washer tall unit  
Armoire haute ouverte pour laveuse  
Hochschrank für Waschmaschine

### P 65

L	F1	F2	F3
70	LAW07020		

### H 200

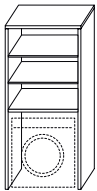

Colonna a giorno per lavatrice + 2 ripiani  
Washer tall unit + 2 shelves  
Armoire haute ouverte pour laveuse + 2 étagères  
Hochschrank für Waschmaschine + 2 Regale

### P 65

L	F1	F2	F3
70	LAW07022		

### H 200

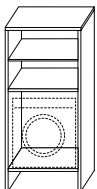

Colonna a giorno per lavatrice + 1 ripiano  
Washer tall unit + 1 shelf  
Armoire haute ouverte pour laveuse + 1 étagère  
Hochschrank für Waschmaschine + 1 Regal

### P 65

L	F1	F2	F3
70	LAW07024		

H  
L  
P

Misure in cm  
Measures in cm  
Mesures en cm  
Maße in cm

**F1** Laccato opaco  
Matt lacquered  
Laqué mat  
Matt lackiert

**F2** Laccato lucido  
Glossy lacquered  
Laqué brillant  
Hochglanz lackiert



**F3** Nobilitati  
Veneer wood  
Placage bois  
Beschichtetes Holz

**F4** Arock®  
Arock®  
Arock®  
Arock®

**F5** abitat / vogue  
abitat / vogue  
abitat / vogue  
abitat / vogue

## Elementi a giorno Laundry units

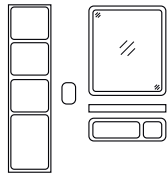
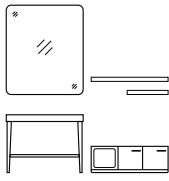
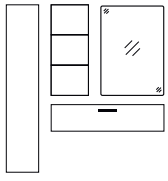
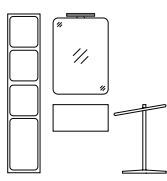
## Éléments ouverts Offene Elemente

					
LAVATOI	UNICAMENTE AROCK®	ALCENTIMETRO PROGETTO	Elementi CONTENTORI	Elementi COMPLEMENTARI	RICAMBI
552	34	98	180	226	592

### H 200

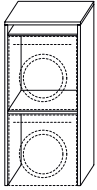

Colonna a giorno per lavatrice + asciugatrice  
Washer + dryer tall unit  
Armoire haute ouverte pour laveuse + sècheuse  
Hochschrank für Waschmaschine + Trockner

### P 65

<b>L</b>	<b>F1</b>	<b>F2</b>	<b>F3</b>
70	LAW07026		



Misure in cm  
Measures in cm  
Mesures en cm  
Maße in cm

**F1** Laccato opaco  
Matt lacquered  
Laqué mat  
Matt lackiert

**F2** Laccato lucido  
Glossy lacquered  
Laqué brillant  
Hochglanz lackiert





**F3** Nobilitati  
Veneer wood  
Placage bois  
Beschichtetes Holz

**F4** Arock®  
Arock®  
Arock®  
Arock®

**F5** abitat / vogue  
abitat / vogue  
abitat / vogue  
abitat / vogue

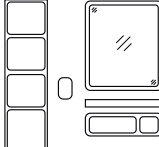
## Basi Units

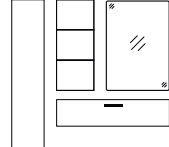
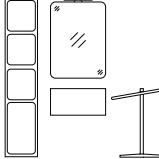
## Meubles bas Unterschränke

					
LAVATOI	UNICAMENTE AROCK®	ALCENTIMETRO PROGETTO	Elementi CONTENITORI	Elementi COMPLEMENTARI	RICAMBI
552	34	98	180	226	592

### H 56

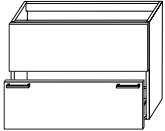

### P 50

Base portalavabo • 1 cassetto chiusura ammortizzata + 1 frontale fisso  
Vanity unit • 1 soft-closing pull-out  
Meuble sous vasque • 1 tiroir amorti  
Waschtischunterschrank • 1 Soft-Closing Schublade

L		F1	F2	F3
70	LAL07004			
90	LAL09004			

### P 65

L		F1	F2	F3
70	LAL07034			
90	LAL09034			

### H 56

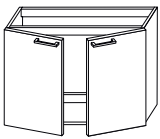

### P 50

Base portalavabo • 2 ante chiusura ammortizzata  
Vanity unit • 2 soft-closing doors  
Meuble sous vasque • 2 portes amorties  
Waschtischunterschrank • 2 Türen

L		F1	F2	F3
70	LAL07005			
90	LAL09005			

### P 65

L		F1	F2	F3
70	LAL07035			
90	LAL09035			

### H 56

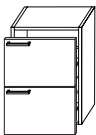

### P 50

Base laterale • 2 cassetti chiusura ammortizzata  
Side unit • 2 soft-closing pull-out  
Meuble bas latéral • 2 tiroirs amortis  
Seitenschrank • 2 Soft-Closing Schubläden

L		F1	F2	F3
35	LAG03504			
45	LAG04504			
50	LAG05004			

### P 65

L		F1	F2	F3
35	LAG03534			
45	LAG04534			
50	LAG05034			

 Misure in cm  
Measures in cm  
Mesures en cm  
Maße in cm

**F1** Laccato opaco  
Matt lacquered  
Laqué mat  
Matt lackiert

**F2** Laccato lucido  
Glossy lacquered  
Laqué brillant  
Hochglanz lackiert

**F3** Nobilitati  
Veneer wood  
Placage bois  
Beschichtetes Holz

**F4** Arock®  
Arock®  
Arock®  
Arock®

**F5** abitat / vogue  
abitat / vogue  
abitat / vogue  
abitat / vogue









## Basi Units

## Meubles bas Unterschränke

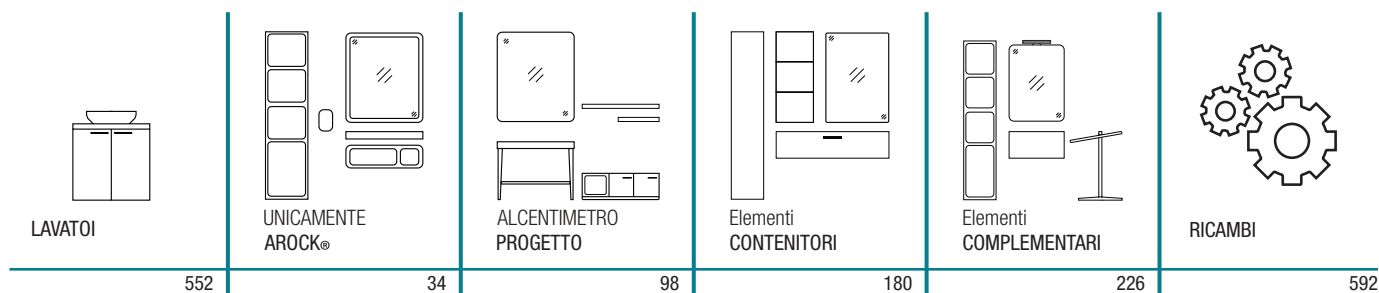

### H 56

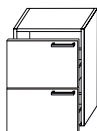

### P 50

Base laterale • 2 cassetti chiusura ammortizzata  
Side unit • 2 soft-closing pull-out  
Meuble bas latéral • 2 tiroirs amortis  
Seitenschrank • 2 Soft-Closing Schubladen

L		F1	F2	F3
35	LAG03505			
45	LAG04505			
50	LAG05005			

### P 65

L		F1	F2	F3
35	LAG03535			
45	LAG04535			
50	LAG05035			

### H 56

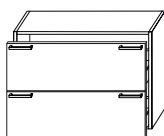

### P 50

Base laterale • 2 cassetti chiusura ammortizzata  
Side unit • 2 soft-closing pull-out  
Meuble bas latéral • 2 tiroirs amortis  
Seitenschrank • 2 Soft-Closing Schubladen

L		F1	F2	F3
70	LAG07004			
90	LAG09004			

### P 65

L		F1	F2	F3
70	LAG07034			
90	LAG09034			

### H 56

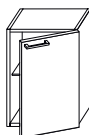

### P 50

Base laterale dx • 1 anta chiusura ammortizzata + 1 ripiano  
Side unit • 1 soft-closing door + 1 shelf  
Meuble bas latéral • 1 porte amortie + 1 étagère  
Seitenschrank • 1 Tür + 1 Regal

L		F1	F2	F3
35	LAB03502			
45	LAB04502			
50	LAB05002			

### P 65

L		F1	F2	F3
35	LAB03532			
45	LAB04532			
50	LAB05032			



Misure in cm  
Measures in cm  
Mesures en cm  
Maße in cm

**F1** Laccato opaco  
Matt lacquered  
Laqué mat  
Matt lackiert

**F2** Laccato lucido  
Glossy lacquered  
Laqué brillant  
Hochglanz lackiert



**F3** Nobilitati  
Veneer wood  
Placage bois  
Beschichtetes Holz

**F4** Arock®  
Arock®  
Arock®  
Arock®

**F5** abitat / vogue  
abitat / vogue  
abitat / vogue  
abitat / vogue

## Basi Units

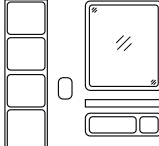
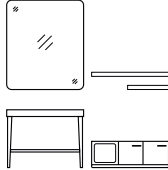
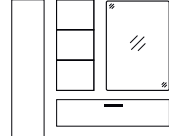
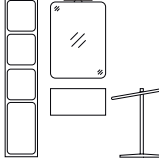
## Meubles bas Unterschränke

					
LAVATOI	UNICAMENTE AROCK®	ALCENTIMETRO PROGETTO	Elementi CONTENITORI	Elementi COMPLEMENTARI	RICAMBI
552	34	98	180	226	592

### H 56



### P 50

Base laterale sx • 1 anta chiusura ammortizzata + 1 ripiano  
Side unit • 1 soft-closing door + 1 shelf  
Meuble bas latéral • 1 porte amortie + 1 étagère  
Seitenschrank • 1 Tür + 1 Regal

L		F1	F2	F3
35	LAB03503			
45	LAB04503			
50	LAB05003			

### P 65

L		F1	F2	F3
35	LAB03533			
45	LAB04533			
50	LAB05033			

### H 56



### P 50

Base laterale • 2 ante chiusura ammortizzata + 1 ripiano  
Side unit • 2 soft-closing doors + 1 shelf  
Meuble bas latéral • 2 portes amorties + 1 étagère  
Seitenschrank • 2 Türen + 1 Regal

L		F1	F2	F3
70	LAB07005			
90	LAB09005			

### P 65

L		F1	F2	F3
70	LAB07035			
90	LAB09035			

### H 76

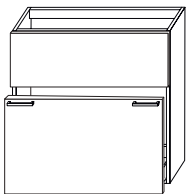

### P 50

Base portlavabo • 1 cassetto chiusura ammortizzata + 1 frontale fisso  
Vanity unit • 1 soft-closing pull-out  
Meuble sous vasque • 1 tiroir amorti  
Waschtischunterschrank • 1 Soft-Closing Schublade

L		F1	F2	F3
70	LAL07022			
90	LAL09022			

  
 Misure in cm  
 Measures in cm  
 Mesures en cm  
 Maße in cm

**F1** Laccato opaco  
 Matt lacquered  
 Laqué mat  
 Matt lackiert

**F2** Laccato lucido  
 Glossy lacquered  
 Laqué brillant  
 Hochglanz lackiert



**F3** Nobilitati  
 Veneer wood  
 Placage bois  
 Beschichtetes Holz

**F4** Arock®  
 Arock®  
 Arock®  
 Arock®

**F5** abitat / vogue  
 abitat / vogue  
 abitat / vogue  
 abitat / vogue

## Basi Units

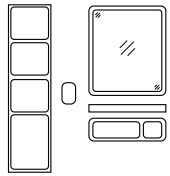
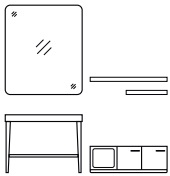
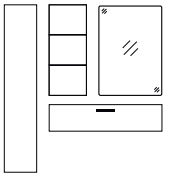
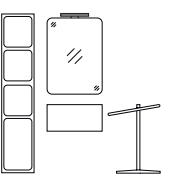
## Meubles bas Unterschränke

					
LAVATOI	UNICAMENTE AROCK®	ALCENTIMETRO PROGETTO	Elementi CONTENTORI	Elementi COMPLEMENTARI	RICAMBI
552	34	98	180	226	592

### H 76

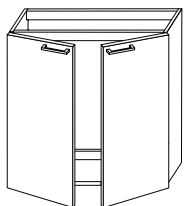

### P 50

Base port lavabo • 2 ante chiusura ammortizzata  
Vanity unit • 2 soft-closing doors  
Meuble sous vasque • 2 portes amorties  
Waschtischunterschrank • 2 Türen

L		F1	F2	F3
70	LAL07024			
90	LAL09024			

### H 76

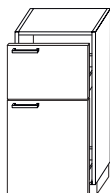

### P 50

Base laterale • 2 cassetti chiusura ammortizzata  
Side unit • 2 soft-closing pull-out  
Meuble bas latéral • 2 tiroirs amortis  
Seitenschrank • 2 Soft-Closing Schubladen

L		F1	F2	F3
35	LAG03522			
45	LAG04522			
50	LAG05022			

### H 76

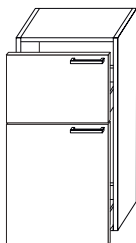

### P 50

Base laterale • 2 cassetti chiusura ammortizzata  
Side unit • 2 soft-closing pull-out  
Meuble bas latéral • 2 tiroirs amortis  
Seitenschrank • 2 Soft-Closing Schubladen

L		F1	F2	F3
35	LAG03523			
45	LAG04523			
50	LAG05023			



Misure in cm  
Measures in cm  
Mesures en cm  
Maße in cm

**F1** Laccato opaco  
Matt lacquered  
Laqué mat  
Matt lackiert

**F2** Laccato lucido  
Glossy lacquered  
Laqué brillant  
Hochglanz lackiert





**F3** Nobilitati  
Veneer wood  
Placage bois  
Beschichtetes Holz

**F4** Arock®  
Arock®  
Arock®

**F5** abitat / vogue  
abitat / vogue  
abitat / vogue  
abitat / vogue

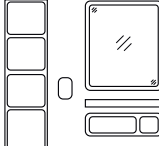
## Basi Units

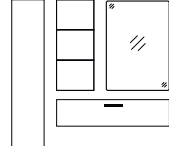
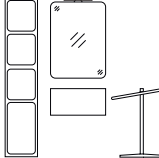
## Meubles bas Unterschränke

					
LAVATOI	UNICAMENTE AROCK®	ALCENTIMETRO PROGETTO	Elementi CONTENITORI	Elementi COMPLEMENTARI	RICAMBI
552	34	98	180	226	592

### H 76

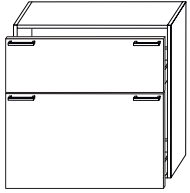

### P 50

Base laterale • 2 cassetti chiusura ammortizzata  
Side unit • 2 soft-closing pull-out  
Meuble bas latéral • 2 tiroirs amortis  
Seitenschrank • 2 Soft-Closing Schubladen

L		F1	F2	F3
70	LAG07022			
90	LAG09022			

### H 76

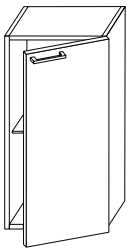

### P 50

Base laterale dx • 1 anta chiusura ammortizzata + 1 ripiano  
Side unit • 1 soft-closing door + 1 shelf  
Meuble bas latéral • 1 porte amortie + 1 étagère  
Seitenschrank • 1 Tür + 1 Regal

L		F1	F2	F3
35	LAB03520			
45	LAB04520			
50	LAB05020			

### H 76

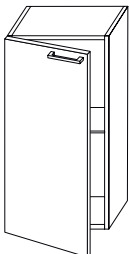

### P 50

Base laterale sx • 1 anta chiusura ammortizzata + 1 ripiano  
Side unit • 1 soft-closing door + 1 shelf  
Meuble bas latéral • 1 porte amortie + 1 étagère  
Seitenschrank • 1 Tür + 1 Regal

L		F1	F2	F3
35	LAB03521			
45	LAB04521			
50	LAB05021			

 Misure in cm  
Measures in cm  
Mesures en cm  
Maße in cm

**F1** Laccato opaco  
Matt lacquered  
Laqué mat  
Matt lackiert

**F2** Laccato lucido  
Glossy lacquered  
Laqué brillant  
Hochglanz lackiert

**F3** Nobilitati  
Veneer wood  
Placage bois  
Beschichtetes Holz

**F4** Arock®  
Arock®  
Arock®  
Arock®

**F5** abitat / vogue  
abitat / vogue  
abitat / vogue  
abitat / vogue

## Basi Units

## Meubles bas Unterschränke

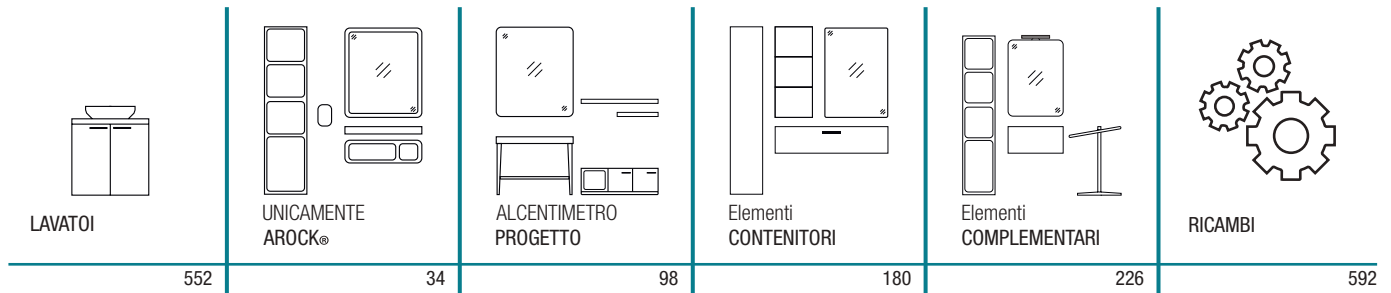

### H 76

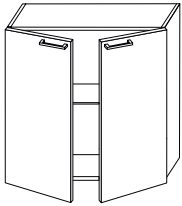

### P 50

Base laterale • 2 ante chiusura ammortizzata + 1 ripiano  
Side unit • 2 soft-closing doors + 1 shelf  
Meuble bas latéral • 2 portes amorties + 1 étagère  
Seitenschrank • 2 Türen + 1 Regal

L	F1	F2	F3
70	LAB07024		
90	LAB09024		

### H 88

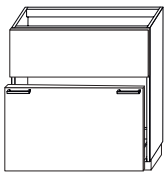

### P 50

Base portalavabo • 1 cassetto chiusura ammortizzata + 1 frontale fisso • zoccolo H 12 incl.  
Vanity unit • 1 soft-closing pull-out • toe-kick H 12 incl.  
Meuble sous vasque • 1 tiroir amorti • socle H 12 incl.  
Waschtischunterschrank • 1 Soft-Closing Schublade • Sockel H 12 inkl.

L	F1	F2	F3
70	LAL07012		
90	LAL09012		

### P 65

L	F1	F2	F3
70	LAL07042		
90	LAL09042		

### H 88

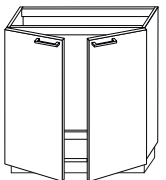

### P 50

Base portalavabo • 2 ante chiusura ammortizzata • zoccolo H 12 incl.  
Vanity unit • 2 soft-closing doors • toe-kick H 12 incl.  
Meuble sous vasque • 2 portes amorties • socle H 12 incl.  
Waschtischunterschrank • 2 Türen • Sockel H 12 inkl.

L	F1	F2	F3
70	LAL07014		
90	LAL09014		

### P 65

L	F1	F2	F3
70	LAL07044		
90	LAL09044		



Misure in cm  
Measures in cm  
Mesures en cm  
Maße in cm

**F1** Laccato opaco  
Matt lacquered  
Laqué mat  
Matt lackiert

**F2** Laccato lucido  
Glossy lacquered  
Laqué brillant  
Hochglanz lackiert



**F3** Nobilitati  
Veneer wood  
Placage bois  
Beschichtetes Holz

**F4** Arock®  
Arock®  
Arock®  
Arock®

**F5** abitat / vogue  
abitat / vogue  
abitat / vogue  
abitat / vogue

## Basi Units

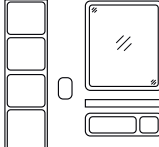
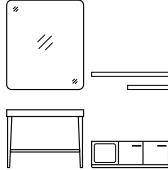
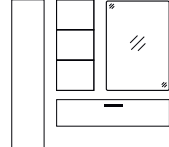
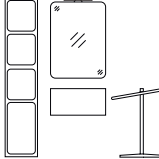
## Meubles bas Unterschränke

					
LAVATOI	UNICAMENTE AROCK®	ALCENTIMETRO PROGETTO	Elementi CONTENITORI	Elementi COMPLEMENTARI	RICAMBI
552	34	98	180	226	592

### H 88

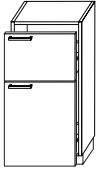

### P 50

Base laterale • 2 cassetti chiusura ammortizzata • zoccolo H 12 incl.  
Side unit • 2 soft-closing pull-out • toe-kick H 12 incl.  
Meuble bas latéral • 2 tiroirs amortis • socle H 12 incl.  
Seitenschrank • 2 Soft-Closing Schubladen • Sockel H 12 inkl.

L		F1	F2	F3
35	LAG03512			
45	LAG04512			
50	LAG05012			

### P 65

L		F1	F2	F3
35	LAG03542			
45	LAG04542			
50	LAG05042			

### H 88

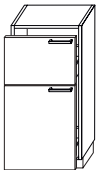

### P 50

Base laterale • 2 cassetti chiusura ammortizzata • zoccolo H 12 incl.  
Side unit • 2 soft-closing pull-out • toe-kick H 12 incl.  
Meuble bas latéral • 2 tiroirs amortis • socle H 12 incl.  
Seitenschrank • 2 Soft-Closing Schubladen • Sockel H 12 inkl.

L		F1	F2	F3
35	LAG03513			
45	LAG04513			
50	LAG05013			

### P 65

L		F1	F2	F3
35	LAG03543			
45	LAG04543			
50	LAG05043			

### H 88

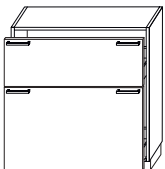

### P 50

Base laterale • 2 cassetti chiusura ammortizzata • zoccolo H 12 incl.  
Side unit • 2 soft-closing pull-out • toe-kick H 12 incl.  
Meuble bas latéral • 2 tiroirs amortis • socle H 12 incl.  
Seitenschrank • 2 Soft-Closing Schubladen • Sockel H 12 inkl.

L		F1	F2	F3
70	LAG07012			
90	LAG09012			

### P 65

L		F1	F2	F3
70	LAG07042			
90	LAG09042			

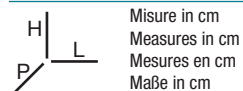

Misure in cm  
Measures in cm  
Mesures en cm  
Maße in cm

**F1** Laccato opaco  
Matt lacquered  
Laqué mat  
Matt lackiert

**F2** Laccato lucido  
Glossy lacquered  
Laqué brillant  
Hochglanz lackiert

**F3** Nobilitati  
Veneer wood  
Placage bois  
Beschichtetes Holz

**F4** Arock®  
Arock®  
Arock®  
Arock®

**F5** abitat / vogue  
abitat / vogue  
abitat / vogue  
abitat / vogue

## Basi Units

## Meubles bas Unterschränke

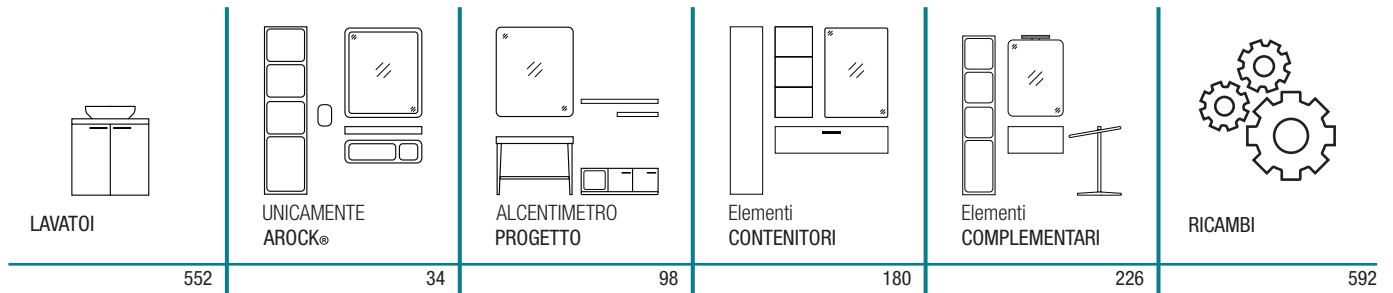

### H 88

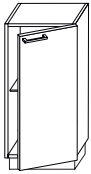

### P 50

Base laterale dx • 1 anta chiusura ammortizzata + 1 ripiano • zoccolo H 12 incl.  
Side unit • 1 soft-closing door + 1 shelf • toe-kick H 12 incl.  
Meuble bas latéral • 1 porte amortie + 1 étagère • socle H 12 incl.  
Seitenschrank • 1 Tür + 1 Regal • Sockel H 12 inkl.

L		F1	F2	F3
35	LAB03510			
45	LAB04510			
50	LAB05010			

### P 65

L		F1	F2	F3
35	LAB03540			
45	LAB04540			
50	LAB05040			

### H 88

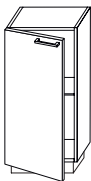

### P 50

Base laterale sx • 1 anta chiusura ammortizzata + 1 ripiano • zoccolo H 12 incl.  
Side unit • 1 soft-closing door + 1 shelf • toe-kick H 12 incl.  
Meuble bas latéral • 1 porte amortie + 1 étagère • socle H 12 incl.  
Seitenschrank • 1 Tür + 1 Regal • Sockel H 12 inkl.

L		F1	F2	F3
35	LAB03511			
45	LAB04511			
50	LAB05011			

### P 65

L		F1	F2	F3
35	LAB03541			
45	LAB04541			
50	LAB05041			

### H 88

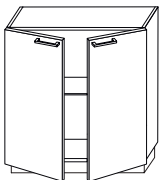

### P 50

Base laterale • 2 ante chiusura ammortizzata + 1 ripiano • zoccolo H 12 incl.  
Side unit • 2 soft-closing doors + 1 shelf • toe-kick H 12 incl.  
Meuble bas latéral • 2 portes amorties + 1 étagère • socle H 12 incl.  
Seitenschrank • 2 Türen + 1 Regal • Sockel H 12 inkl.

L		F1	F2	F3
70	LAB07014			
90	LAB09014			

### P 65

L		F1	F2	F3
70	LAB07044			
90	LAB09044			



Misure in cm  
Measures in cm  
Mesures en cm  
Maße in cm

**F1** Laccato opaco  
Matt lacquered  
Laqué mat  
Matt lackiert

**F2** Laccato lucido  
Glossy lacquered  
Laqué brillant  
Hochglanz lackiert

**F3** Nobilitati  
Veneer wood  
Placage bois  
Beschichtetes Holz





**F4** Arock®  
Arock®  
Arock®  
Arock®

**F5** abitat / vogue  
abitat / vogue  
abitat / vogue  
abitat / vogue

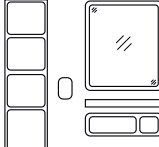

## Basi Units

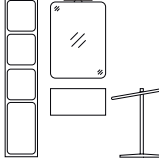
## Meubles bas Unterschränke

					
LAVATOI	UNICAMENTE AROCK®	ALCENTIMETRO PROGETTO	Elementi CONTENITORI	Elementi COMPLEMENTARI	RICAMBI
552	34	98	180	226	592

### H 88

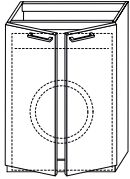

### P 50

Base laterale portalavatrice • 2 ante chiusura ammortizzata • zoccolo H 12 incl.  
Washer unit • 2 soft-closing doors • toe-kick H 12 incl.  
Meuble bas latéral pour laveuse • 2 portes amorties • socle H 12 incl.  
Seitenschrank für Waschmaschine • 2 Türen • Sockel H 12 inkl.

L  
70 LAW07002

F1

F2

F3

### P 65

L  
70 LAW07004

F1

F2

F3

### H 88

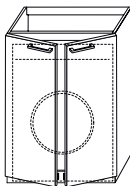

Base laterale per asciugatrice • 2 ante chiusura ammortizzata • zoccolo H 12 incl.  
Dryer unit • 2 soft-closing doors • toe-kick H 12 incl.  
Meuble bas latéral pour sècheuse • 2 portes amorties • socle H 12 incl.  
Seitenschrank für Trockner • 2 Türen • Sockel H 12 inkl.

### P 65

L  
70 LAW07006

F1

F2

F3

H  
L  
P

Misure in cm  
Measures in cm  
Mesures en cm  
Maße in cm

**F1** Laccato opaco  
Matt lacquered  
Laqué mat  
Matt lackiert

**F2** Laccato lucido  
Glossy lacquered  
Laqué brillant  
Hochglanz lackiert

**F3** Nobilitati  
Veneer wood  
Placage bois  
Beschichtetes Holz

**F4** Arock®  
Arock®  
Arock®  
Arock®

**F5** abitat / vogue  
abitat / vogue  
abitat / vogue  
abitat / vogue

# Colonne attrezzate Laundry tall cabinets

# Armoires hautes sur pieds Hochschränke-stehend

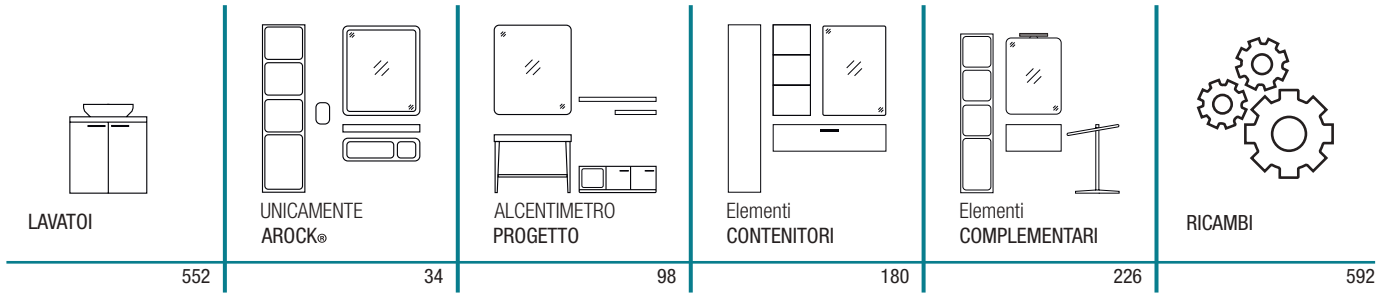

## H 200

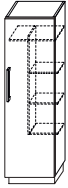

## P 50

Colonna dx per ripostiglio • 1 anta chiusura ammortizzata • zoccolo H 12 incl.  
Storage tall cabinet • 1 soft-closing door • toe-kick H 12 incl.  
Armoire haute de rangement • 1 porte amortie • socle H 12 incl.  
Hochschrank-stehend • 1 Tür • Sockel H 12 inkl.

L	F1	F2	F3
45 LAC04558			

## P 65

L	F1	F2	F3
45 LAC04560			

## H 200

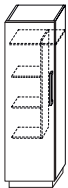

## P 50

Colonna sx per ripostiglio • 1 anta chiusura ammortizzata • zoccolo H 12 incl.  
Storage tall cabinet • 1 soft-closing door • toe-kick H 12 incl.  
Armoire haute de rangement • 1 porte amortie • socle H 12 incl.  
Hochschrank-stehend • 1 Tür • Sockel H 12 inkl.

L	F1	F2	F3
45 LAC04559	670	720	480

## P 65

L	F1	F2	F3
45 LAC04561	775	835	540

## H 200

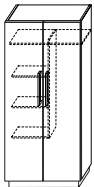

## P 50

Colonna per ripostiglio • 2 ante chiusura ammortizzata • zoccolo H 12 incl.  
Storage tall cabinet • 2 soft-closing doors • toe-kick H 12 incl.  
Armoire haute de rangement • 2 portes amorties • socle H 12 incl.  
Hochschrank-stehend • 2 Türen • Sockel H 12 inkl.

L	F1	F2	F3
70 LAC07062			

## P 65

L	F1	F2	F3
70 LAC07063			



Misure in cm  
Measures in cm  
Mesures en cm  
Maße in cm

**F1** Laccato opaco  
Matt lacquered  
Laqué mat  
Matt lackiert

**F2** Laccato lucido  
Glossy lacquered  
Laqué brillant  
Hochglanz lackiert

**F3** Nobilitati  
Veneer wood  
Placage bois  
Beschichtetes Holz

**F4** Arock®  
Arock®  
Arock®

**F5** abitat / vogue  
abitat / vogue  
abitat / vogue  
abitat / vogue

## Colonne attrezzate Laundry tall cabinets

## Armoires hautes sur pieds Hochschranke-stehend

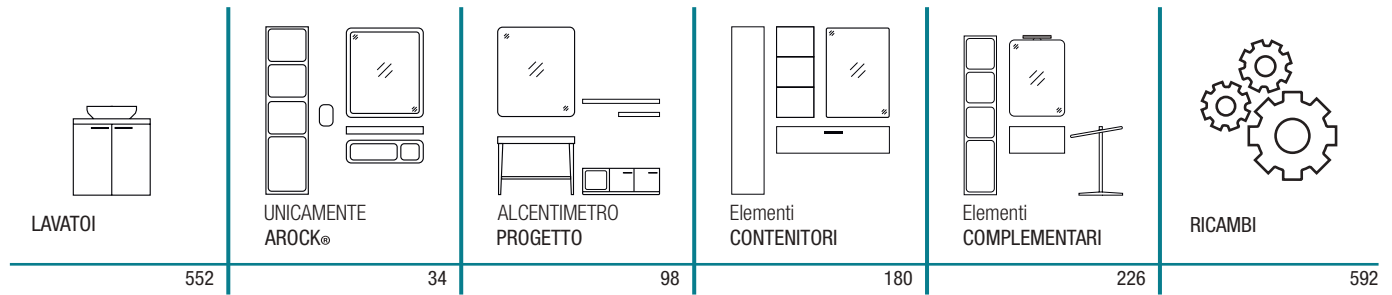

### H 200

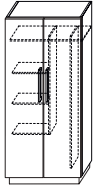

### P 50

Colonna per ripostiglio • 2 ante chiusura ammortizzata + divisorio interno • zoccolo H 12 incl.  
Storage tall cabinet • 2 soft-closing doors + internal partition • toe-kick H 12 incl.  
Armoire haute de rangement • 2 portes amorties + diviseur interne • socle H 12 incl.  
Hochschrank-stehend • 2 Türen + interner Teiler • Sockel H 12 inkl.

L	F1	F2	F3
70 LAC07064			

### P 65

L	F1	F2	F3
70 LAC07065			

### H 200

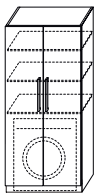

Colonna per lavatrice • 2 ante chiusura ammortizzata • zoccolo H 12 incl.  
Washer tall cabinet • 2 soft-closing doors • toe-kick H 12 incl.  
Armoire haute pour laveuse • 2 portes amorties • socle H 12 incl.  
Hochschrank-stehend für Waschmaschine • 2 Türen • Sockel H 12 inkl.

### P 65

L	F1	F2	F3
70 LAW07008			

### H 200

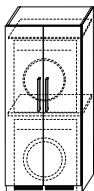

Colonna per lavatrice + asciugatrice • 2 ante chiusura ammortizzata • zoccolo H 12 incl.  
Washer + dryer tall cabinet • 2 soft-closing doors • toe-kick H 12 incl.  
Armoire haute pour laveuse + sècheuse • 2 portes amorties • socle H 12 incl.  
Hochschrank-stehend für Waschmaschine + Trockner • 2 Türen • Sockel H 12 inkl.

### P 65

L	F1	F2	F3
70 LAW07009			

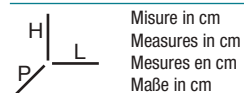

Misure in cm  
Measures in cm  
Mesures en cm  
Maße in cm

**F1** Laccato opaco  
Matt lacquered  
Laqué mat  
Matt lackiert

**F2** Laccato lucido  
Glossy lacquered  
Laqué brillant  
Hochglanz lackiert

**F3** Nobilitati  
Veneer wood  
Placage bois  
Beschichtetes Holz

**F4** Arock®  
Arock®  
Arock®  
Arock®

**F5** abitat / vogue  
abibat / vogue  
abibat / vogue  
abibat / vogue

## Colonne attrezzate Laundry tall cabinets

## Armoires hautes sur pieds Hochschränke-stehend

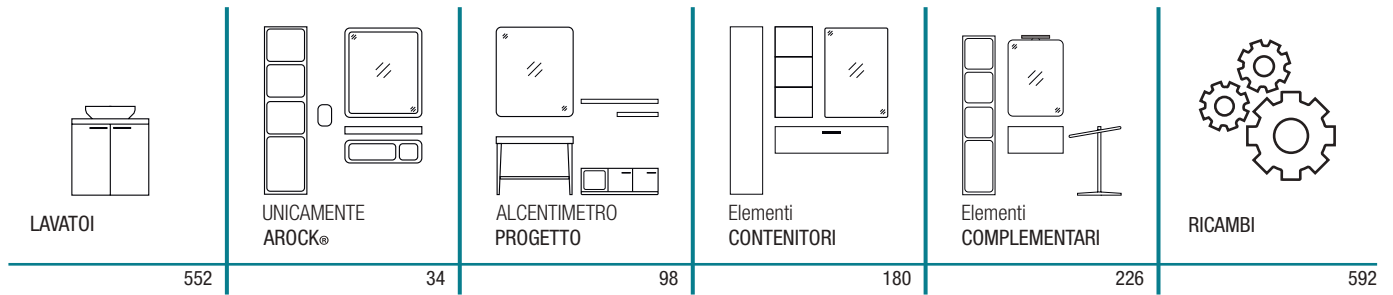

### H 200

### P 34

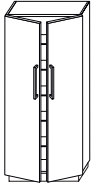

Colonna per scarpiera • 2 ante chiusura ammortizzata • zoccolo H 12 incl.  
Shoe tall cabinet • 2 soft-closing doors • toe-kick H 12 incl.  
Armoire haute à chaussures • 2 portes amorties • socle H 12 incl.  
Hochschrank-stehend für Schuhe • 2 Türen • Sockel H 12 inkl.

L **F1** **F2** **F3**  
70 LAC07054

### H 200

### P 50

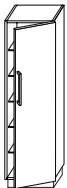

Colonna dx • 1 anta chiusura ammortizzata • zoccolo H 12 incl.  
Tall cabinet • 1 soft-closing door • toe-kick H 12 incl.  
Armoire haute • 1 porte amortie • socle H 12 incl.  
Hochschrank-stehend • 1 Tür • Sockel H 12 inkl.

L **F1** **F2** **F3**  
45 LAC04570

### P 65

L **F1** **F2** **F3**  
45 LAC04572

### H 200

### P 50



Colonna sx • 1 anta chiusura ammortizzata • zoccolo H 12 incl.  
Tall cabinet • 1 soft-closing door • toe-kick H 12 incl.  
Armoire haute • 1 porte amortie • socle H 12 incl.  
Hochschrank-stehend • 1 Tür • Sockel H 12 inkl.

L **F1** **F2** **F3**  
45 LAC04571

### P 65

L **F1** **F2** **F3**  
45 LAC04573



Misure in cm  
Measures in cm  
Mesures en cm  
Maße in cm

**F1** Laccato opaco  
Matt lacquered  
Laqué mat  
Matt lackiert

**F2** Laccato lucido  
Glossy lacquered  
Laqué brillant  
Hochglanz lackiert



**F3** Nobilitati  
Veneer wood  
Placage bois  
Beschichtetes Holz

**F4** Arock®  
Arock®  
Arock®

**F5** abitat / vogue  
abitat / vogue  
abitat / vogue  
abitat / vogue

## Colonne attrezzate Laundry tall cabinets

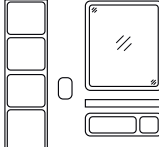
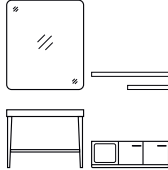
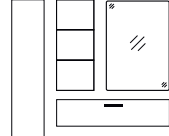
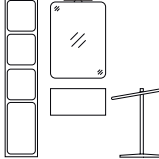
## Armoires hautes sur pieds Hochschränke-stehend

					
LAVATOI	UNICAMENTE AROCK®	ALCENTIMETRO PROGETTO	Elementi CONTENITORI	Elementi COMPLEMENTARI	RICAMBI
552	34	98	180	226	592

### H 200

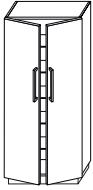

### P 50

Colonna • 2 ante chiusura ammortizzata • zoccolo H 12 incl.  
Tall cabinet • 2 soft-closing doors • toe-kick H 12 incl.  
Armoire haute • 2 portes amorties • socle H 12 incl.  
Hochschrank-stehend • 2 Türen • Sockel H 12 inkl.

**L**

70 LAC07075

**F1**
**F2**
**F3**

### P 65

**L**

70 LAC07076

**F1**
**F2**
**F3**

 Misure in cm  
Measures in cm  
Mesures en cm  
Maße in cm

**F1** Laccato opaco  
Matt lacquered  
Laqué mat  
Matt lackiert

**F2** Laccato lucido  
Glossy lacquered  
Laqué brillant  
Hochglanz lackiert

**F3** Nobilitati  
Veneer wood  
Placage bois  
Beschichtetes Holz

**F4** Arock®  
Arock®  
Arock®  
Arock®

**F5** abitat / vogue  
abitat / vogue  
abitat / vogue  
abitat / vogue











## Ricambi Spare parts

## Pièces détachées Ersatzteile



### SIFONE SALVASPAZIO SPACE-SAVING SIPHON

### SIPHON GAIN DE PLACE PLATZSPARENDER SIPHON

**cod.**

**OMASIF05**

Sifone in ABS bianco - sagomato e snodabile adatto agli spazi ridotti  
White ABS Syphon - shaped and articulated for reduced spaces  
Syphon en ABS blanc - courbé et demontable pour s'adapter aux espaces réduits

Weißes Gelenksiphon aus ABS - geformt für kleine Räume



### PILETTA CLICK-CLACK WASTE KIT CLICK-CLACK

### BONDE D'EVACUATION CLICK-CLACK CLICK-CLACK ABLAUF KIT

**cod.**

**OMASIF06**

Piletta cromata con apertura click-clack completa di scarico per fissaggio al sifone

Click-Clack chrome drain complete with waste for attachment to the syphon

Bonde chromée avec système click-clack complète pour fixation au siphon  
Verchromtes click-clack Ablaufsystem mit click-clack Öffnung inkl. Abfluss für Befestigung am Siphon



### DISTANZIALE CLICK-CLACK DRAIN SPACER CLICK-CLACK

### REHAUSSE CLICK-CLACK ABASTANDHALTER

**cod.**

**OMASIF07**

Distanziale per piletta H 2 cm in alluminio - cromato

ABS Drain spacer H 2 cm - chrome

Rehausse de bonde en ABS H 2 cm - chromée

Abstandhalter für Ablaufsystem aus ABS H 2 cm - verchromt



### DISTANZIALE PILETTA DRAIN SPACER

### REHAUSSE DE BONDE ABASTANDHALTER

**cod.**

**OMASIF03**

Distanziale per piletta H 3,5 cm in alluminio - cromato

ABS Drain spacer H 3,5 cm - chrome

Rehausse de bonde en ABS H 3,5 cm - chromée

Abstandhalter für Ablaufsystem aus ABS H 3,5 cm - verchromt

## Ricambi Spare parts

## Pièces détachées Ersatzteile



### FASCIA MANIGLIA GIUSTO HANDLE PROFILE

### PROFIL POIGNÉE GRIFFLEISTE

#### cod.

<b>OMAGOL02</b>	superiore / upper / supérieure / obere
<b>OMAGOL04</b>	centrale / central / centrale / zentrale

Profilo gola in alluminio estruso  
Aluminium handle profile  
Profil poignée en aluminium extrudé  
Die Griffleiste aus extrudiertem Aluminium



### MANIGLIA PONTE PONTE HANDLE

### POIGNÉE PONTE PONTE GRIFF

#### cod.

<b>OMAMAN01</b>	CROMO OPACO	2 pz.
<b>OMAMAN02</b>	TITANIO	2 pz.
<b>OMAMAN03</b>	ORO OPACO SATINATO	2 pz.
<b>OMAMAN04</b>	NERO OPACO	2 pz.
<b>OMAMAN05</b>	COLORE LACCATO OPACO	2 pz.

Coppia di maniglie in alluminio L 33 cm / interasse 32 cm  
Pair of aluminum handles L 33 cm / center distance 32 cm  
Paire de poignées en aluminium L 33 cm / entraxe 32 cm  
Paar Aluminiumgriffe L 33 cm / Achsabstand 32 cm



### MANIGLIA TALETE TALETE HANDLE

### POIGNÉE TALETE TALETE GRIFF

<b>OMAMAN06</b>	COLORE LACCATO OPACO	2 pz.
-----------------	----------------------	-------

## Ricambi Spare parts

## Pièces détachées Ersatzteile



Ripiani in vetro H 0,6 cm  
Glass shelves H 0,6 cm  
Étagère en verre H 0,6 cm  
Glasregale H 0,6 cm

- per basi portalavabo  
for vanity unit  
pour meuble sous-vasque  
für Waschtischunterschrank



Ripiano in vetro H 0,6 cm  
Glass shelf H 0,6 cm  
Étagère en verre H 0,6 cm  
Glasregal H 0,6 cm

- per basi portalavabo  
for vanity unit  
pour meuble sous-vasque  
für Waschtischunterschrank

### RIPIANO IN VETRO - LEALE GLASS SHELF

### ÉTAGÈRE EN VITRAGE GLASREGAL

cod.	P	L
OMARIP60	18	30
OMARIP61	18	35
OMARIP62	18	45
OMARIP63	18	60
OMARIP64	18	70
OMARIP65	18	90

OMARIP66	34	30
OMARIP67	34	35
OMARIP68	34	45
OMARIP69	34	60
OMARIP70	34	70

OMARIP71	45	30
OMARIP72	45	35
OMARIP73	45	45
OMARIP74	45	60
OMARIP75	45	70
OMARIP76	45	90
OMARIP77	45	105

● OMARIP78	45	60
● OMARIP79	45	70
● OMARIP80	45	90

OMARIP81	51,5	30
OMARIP82	51,5	35
OMARIP83	51,5	45
OMARIP84	51,5	60
OMARIP85	51,5	70
OMARIP86	51,5	90
OMARIP87	51,5	105

● OMARIP88	51,5	60
● OMARIP89	51,5	70
● OMARIP90	51,5	105

OMARIP91	45 / 51,5	120
----------	-----------	-----

### RIPIANO IN VETRO - LIBERO GLASS SHELF

### ÉTAGÈRE EN VITRAGE GLASREGAL

cod.	P	L
● OMARIQ01	46	60
● OMARIQ02	46	70
● OMARIQ03	46	80
● OMARIQ04	46	90
● OMARIQ05	46	105
● OMARIQ06	46	120

● OMARIQ08	51,5	60
● OMARIQ09	51,5	70
● OMARIQ10	51,5	80
● OMARIQ11	51,5	90
● OMARIQ12	51,5	105
● OMARIQ13	51,5	120

## Ricambi Spare parts

## Pièces détachées Ersatzteile



Ripiani in vetro H 0,6 cm  
Glass shelves H 0,6 cm  
Étagère en verre H 0,6 cm  
Glasregale H 0,6 cm

- per basi portalavabo  
for vanity unit  
pour meuble sous-vasque  
für Waschtischunterschrank

### RIPIANO IN VETRO - GIUSTO GLASS SHELF

### ÉTAGÈRE EN VITRAGE GLASREGAL

cod.	P	L
OMARIP30	18	27
OMARIP31	18	36
OMARIP32	18	54
OMARIP33	18	72

● OMARIP34	45	54
● OMARIP35	45	63
● OMARIP36	45	72
● OMARIP37	45	81
● OMARIP38	45	90
● OMARIP39	45	108

OMARIP40	45	27
OMARIP41	45	36

OMARIP42	45	54
OMARIP43	45	63
OMARIP44	45	72
OMARIP45	45	81
OMARIP46	45	90
OMARIP47	45	108

● OMARIP42	51,5	54
● OMARIP43	51,5	63
● OMARIP44	51,5	72
● OMARIP45	51,5	81
● OMARIP46	51,5	90
● OMARIP47	51,5	108

OMARIP50	51,5	27
OMARIP51	51,5	36
OMARIP52	51,5	54
OMARIP53	51,5	63
OMARIP54	51,5	72
OMARIP55	51,5	81
OMARIP56	51,5	90
OMARIP57	51,5	108

## SPARTAN®

cod.

OMAKIT05

Sigillante cristallino neutro. Trasparente dopo l'asciugatura. Senza solventi, senza odore. Non ritira durante l'asciugatura

Neutral crystalline sealant, transparent after drying. Without solvent.

Odourless, does not shrink in drying

Silicone transparent. Sans solvant, sans odeur et sans retrait

Kristallklarer geruchloser Dichtstoff, bleibt nach der kompletten Trocknung völlig transparent. Ohne Lösemittel, sieht keine mechanische Einschränkung nach der Trocknung vor



## Parte tecnica generale Technical section

## Section technique Technischen Teil

### MANUTENZIONE / USO MAINTENANCE / USE

### MAINTENANCE / USAGE UNTERHALTUNG / NUTZUNG

	DA UTILIZZARE	DA EVITARE
<b>Superfici Laccate</b>	panni morbidi in cotone o microfibra inumiditi con acqua o con prodotti naturali tipo quelli per la pulizia del vetro che non contengono solventi. Asciugare sempre con un panno morbido. Per macchie insistenti usare detergenti neutri diluiti con acqua	spugne ruvide e abrasive, pagliette metalliche; prodotti abrasivi o prodotti contenenti solventi, cloro o acidi, prodotti anticalcare e acetoni
<b>Superfici in Nobilitato</b>	panni morbidi in cotone o microfibra inumiditi con acqua o con prodotti naturali tipo quelli per la pulizia del vetro che non contengono solventi. Asciugare sempre con un panno morbido. Per macchie insistenti usare detergenti neutri diluiti con acqua	spugne ruvide e abrasive, pagliette metalliche; prodotti abrasivi o prodotti contenenti solventi, cloro o acidi, prodotti anticalcare e acetoni; prodotti contenenti diluenti sui bordi possono provocare rammollimenti e deformazioni
<b>Superfici in HPL</b>	panni morbidi in cotone o microfibra inumiditi con acqua o con prodotti naturali tipo quelli per la pulizia del vetro che non contengono solventi. Asciugare sempre con un panno morbido. Per macchie insistenti usare detergenti neutri diluiti con acqua	spugne ruvide e abrasive, pagliette metalliche; prodotti abrasivi o prodotti contenenti solventi, cloro o acidi, prodotti anticalcare e acetoni
<b>Superfici Arock®</b>	panni morbidi in cotone o microfibra inumiditi con acqua o con prodotti naturali tipo quelli per la pulizia del vetro che non contengono solventi. Asciugare sempre con un panno morbido. Per macchie insistenti usare detergenti neutri diluiti con acqua	spugne ruvide e abrasive, pagliette metalliche; prodotti abrasivi o prodotti contenenti solventi, cloro o acidi, prodotti anticalcare e acetoni
<b>Superfici in cristallo extrachiaro</b>	panni morbidi in cotone o microfibra inumiditi con detergenti specifici per la pulizia del vetro. Asciugare sempre con un panno morbido	spugne ruvide e abrasive, pagliette metalliche; prodotti abrasivi o prodotti contenenti solventi, cloro o acidi, prodotti anticalcare e acetoni. Evitare la caduta di oggetti pesanti e l'appoggio di oggetti roventi
<b>Superfici in Silestone</b>	panni morbidi in cotone o microfibra inumiditi con acqua. Asciugare sempre con un panno morbido. Per macchie insistenti usare detergenti neutri diluiti con acqua	spugne ruvide e abrasive, pagliette metalliche; prodotti abrasivi o prodotti contenenti solventi, cloro o acidi, prodotti anticalcare e acetoni. Evitare la caduta di oggetti pesanti e l'appoggio di oggetti roventi
<b>Superfici in Pietra naturale</b>	panni morbidi in cotone o microfibra inumiditi con acqua o con prodotti naturali. Asciugare sempre con un panno morbido. Per macchie insistenti usare detergenti neutri diluiti con acqua.	spugne ruvide e abrasive, pagliette metalliche; prodotti abrasivi o prodotti contenenti solventi, cloro o acidi, prodotti anticalcare e acetoni. Evitare la caduta di oggetti pesanti e l'appoggio di oggetti roventi
<b>Superfici in Gres</b>	utilizzare spugne o panni morbidi, in cotone o microfibra, inumiditi con acqua e/o con detergenti neutri. Risciacquare sempre per bene con acqua e asciugare sempre con un panno morbido	spugne ruvide e abrasive, pagliette metalliche; prodotti abrasivi o prodotti contenenti solventi, cloro o acidi, prodotti anticalcare e acetoni
<b>Superfici in Castmarble</b>	utilizzare panni morbidi in cotone o microfibra inumiditi con acqua o con prodotti specifici. Asciugare sempre con un panno morbido	spugne ruvide e abrasive, pagliette metalliche; prodotti abrasivi o prodotti contenenti solventi, cloro o acidi, prodotti anticalcare e acetoni
<b>Superfici in Tecnoril</b>	utilizzare panni morbidi in cotone o microfibra inumiditi con acqua o con prodotti specifici. Asciugare sempre con un panno morbido	spugne ruvide e abrasive, pagliette metalliche; prodotti abrasivi o prodotti contenenti solventi, cloro o acidi, prodotti anticalcare e acetoni.
<b>Superfici specchio</b>	utilizzare panni morbidi in cotone o microfibra inumiditi con detergenti specifici per vetro/specchio. Asciugare sempre con un panno morbido	spugne ruvide e abrasive, pagliette metalliche; prodotti abrasivi o prodotti contenenti solventi, cloro o acidi, prodotti anticalcare e acetoni
<b>Parti in metallo</b>	utilizzare panni morbidi in cotone o microfibra inumiditi con acqua o con prodotti specifici. Asciugare sempre con un panno morbido	spugne ruvide e abrasive, pagliette metalliche; prodotti abrasivi o prodotti contenenti solventi, cloro o acidi, prodotti anticalcare e acetoni.

## Parte tecnica generale Technical section

## Section technique Technischen Teil

### MAINTENANCE / USE

	TO BE USED	TO AVOID
<b>Lacquered surfaces</b>	soft cotton or microfibre cloths damp with water or natural products without solvents. Dry with a soft cloth. For persistent stains use neutral detergents diluted with water	rough and abrasive sponges, metal wool; abrasive products or with chlorine or greedy solvents, anti-limescale products and acetone
<b>Nobilitato surfaces</b>	soft cotton or microfibre cloths damp with water or natural products without solvents. Dry with a soft cloth. For persistent stains use neutral detergents diluted with water	rough and abrasive sponges, metal wool; abrasive products or with chlorine or greedy solvents, anti-limescale products and acetone; products with thinners can deform the edges
<b>HPL surfaces</b>	soft cotton or microfibre cloths damp with water or natural products without solvents. Dry with a soft cloth. For persistent stains use neutral detergents diluted with water	rough and abrasive sponges, metal wool; abrasive products or with chlorine or greedy solvents, anti-limescale products and acetone
<b>AROCK® surfaces</b>	soft cotton or microfibre cloths damp with water or natural products without solvents. Dry with a soft cloth. For persistent stains use neutral detergents diluted with water	rough and abrasive sponges, metal wool; abrasive products or with chlorine or greedy solvents, anti-limescale products and acetone
<b>EXTRA-CLEAR GLASS surfaces</b>	soft cotton or microfibre cloths damp with water or natural products without solvents. Dry with a soft cloth	rough and abrasive sponges, metal wool; abrasive products or with chlorine or greedy solvents, anti-limescale products and acetone; Avoid falling heavy objects and do not place hot objects on it
<b>SILESTONE surfaces</b>	soft cotton or microfibre cloths damp with water or natural products without solvents. Dry with a soft cloth. For persistent stains use neutral detergents diluted with water	rough and abrasive sponges, metal wool; abrasive products or with chlorine or greedy solvents, anti-limescale products and acetone; Avoid falling heavy objects and do not place hot objects on it
<b>NATURAL STONE surfaces</b>	soft cotton or microfibre cloths damp with water or natural products without solvents. Dry with a soft cloth. For persistent stains use neutral detergents diluted with water	rough and abrasive sponges, metal wool; abrasive products or with chlorine or greedy solvents, anti-limescale products and acetone; Avoid falling heavy objects and do not place hot objects on it
<b>GRES surfaces</b>	soft cotton or microfibre cloths damp with water or natural products without solvents. Dry with a soft cloth	rough and abrasive sponges, metal wool; abrasive products or with chlorine or greedy solvents, anti-limescale products and acetone
<b>CASTMARBLE surfaces</b>	soft cotton or microfibre cloths damp with water or natural products without solvents. Dry with a soft cloth	rough and abrasive sponges, metal wool; abrasive products or with chlorine or greedy solvents, anti-limescale products and acetone
<b>TECNORIL surfaces</b>	soft cotton or microfibre cloths damp with water or specific products without solvents. Dry with a soft cloth	rough and abrasive sponges, metal wool; abrasive products or with chlorine or greedy solvents, anti-limescale products and acetone
<b>Mirror surfaces</b>	soft cotton or microfibre cloths damp with water or specific products without solvents. Dry with a soft cloth	rough and abrasive sponges, metal wool; abrasive products or with chlorine or greedy solvents, anti-limescale products and acetone
<b>Metal parts</b>	soft cotton or microfibre cloths damp with water or specific products without solvents. Dry with a soft cloth	rough and abrasive sponges, metal wool; abrasive products or with chlorine or greedy solvents, anti-limescale products and acetone

**MAINTENANCE / USAGE**

	<b>UTILISER</b>	<b>ÉVITER</b>
<b>Surfaces lacquées</b>	chiffons doux en coton ou microfibras humides avec de l'eau ou des produits naturels sans solvants. Sécher avec un chiffon doux. Pour les taches persistantes utilisez des détergents neutres dilués avec de l'eau	éponges rugueuses et abrasives, laine de métal; produits abrasifs ou avec du chlore ou des solvants gourmands, des produits anticalcaire et de l'acétone
<b>Surfaces en Nobilitato</b>	chiffons doux en coton ou microfibras humides avec de l'eau ou des produits naturels sans solvants. Sécher avec un chiffon doux. Pour les taches persistantes utilisez des détergents neutres dilués avec de l'eau	éponges rugueuses et abrasives, laine de métal; produits abrasifs ou avec du chlore ou des solvants gourmands, des produits anticalcaire et de l'acétone. Les produits avec des diluants peuvent déformer les bords
<b>Surfaces en HPL</b>	chiffons doux en coton ou microfibras humides avec de l'eau ou des produits naturels sans solvants. Sécher avec un chiffon doux. Pour les taches persistantes utilisez des détergents neutres dilués avec de l'eau	éponges rugueuses et abrasives, laine de métal; produits abrasifs ou avec du chlore ou des solvants gourmands, des produits anticalcaire et de l'acétone
<b>Surfaces en AROCK®</b>	chiffons doux en coton ou microfibras humides avec de l'eau ou des produits naturels sans solvants. Sécher avec un chiffon doux. Pour les taches persistantes utilisez des détergents neutres dilués avec de l'eau	éponges rugueuses et abrasives, laine de métal; produits abrasifs ou avec du chlore ou des solvants gourmands, des produits anticalcaire et de l'acétone
<b>Surfaces en VERRE EXTRACLAIR</b>	chiffons doux en coton ou microfibras humides avec de l'eau ou des produits naturels sans solvants. Sécher avec un chiffon doux	éponges rugueuses et abrasives, laine de métal; produits abrasifs ou avec du chlore ou des solvants gourmands, des produits anticalcaire et de l'acétone. Évitez de faire tomber des objets lourds et ne placez pas d'objets chauds dessus
<b>Surfaces en SILESTONE</b>	chiffons doux en coton ou microfibras humides avec de l'eau ou des produits naturels. Sécher avec un chiffon doux. Pour les taches persistantes utilisez des détergents neutres dilués avec de l'eau	éponges rugueuses et abrasives, laine de métal; produits abrasifs ou avec du chlore ou des solvants gourmands, des produits anticalcaire et de l'acétone. Évitez de faire tomber des objets lourds et ne placez pas d'objets chauds dessus
<b>Surfaces en PIERRE NATURELLE</b>	chiffons doux en coton ou microfibras humides avec de l'eau ou des produits naturels. Sécher avec un chiffon doux. Pour les taches persistantes utilisez des détergents neutres dilués avec de l'eau	éponges rugueuses et abrasives, laine de métal; produits abrasifs ou avec du chlore ou des solvants gourmands, des produits anticalcaire et de l'acétone. Évitez de faire tomber des objets lourds et ne placez pas d'objets chauds dessus
<b>Surfaces en GRES</b>	chiffons doux en coton ou microfibras humides avec de l'eau ou des produits naturels. Sécher avec un chiffon doux	éponges rugueuses et abrasives, laine de métal; produits abrasifs ou avec du chlore ou des solvants gourmands, des produits anticalcaire et de l'acétone
<b>Surfaces en CASTAMARBLE</b>	chiffons doux en coton ou microfibras humides avec de l'eau ou des produits spéciaux. Sécher avec un chiffon doux	éponges rugueuses et abrasives, laine de métal; produits abrasifs ou avec du chlore ou des solvants gourmands, des produits anticalcaire et de l'acétone
<b>Surfaces en TECNORIL</b>	chiffons doux en coton ou microfibras humides avec de l'eau ou des produits spéciaux. Sécher avec un chiffon doux	éponges rugueuses et abrasives, laine de métal; produits abrasifs ou avec du chlore ou des solvants gourmands, des produits anticalcaire et de l'acétone
<b>Surfaces en miroir</b>	chiffons doux en coton ou microfibras humides avec de l'eau ou des produits spéciaux. Sécher avec un chiffon doux	éponges rugueuses et abrasives, laine de métal; produits abrasifs ou avec du chlore ou des solvants gourmands, des produits anticalcaire et de l'acétone
<b>Parties en métal</b>	chiffons doux en coton ou microfibras humides avec de l'eau ou des produits spéciaux. Sécher avec un chiffon doux	éponges rugueuses et abrasives, laine de métal; produits abrasifs ou avec du chlore ou des solvants gourmands, des produits anticalcaire et de l'acétone



## Parte tecnica generale Technical section

## Section technique Technischen Teil

### UNTERHALTUNG / NUTZUNG

	ZU BENUTZEN	ZU VERMEIDEN
<b>Lackierte Oberflächen</b>	weiche Baumwoll- oder Mikrofasertücher, die mit Wasser oder Naturprodukten ohne Lösungsmittel angefeuchtet sind. Mit einem weichen Tuch trocknen. Verwenden Sie bei hartnächigen Flecken neutrale Reinigungsmittel, die mit Wasser verdünnt sind	raue und abrasive Schwämme, Metallwolle; Schleifmittel oder mit Chlor oder gierigen Lösungsmitteln, Kalkschutzmitteln und Aceton
<b>Oberflächen aus Nobilitato</b>	weiche Baumwoll- oder Mikrofasertücher, die mit Wasser oder Naturprodukten ohne Lösungsmittel angefeuchtet sind. Mit einem weichen Tuch trocknen. Verwenden Sie bei hartnächigen Flecken neutrale Reinigungsmittel, die mit Wasser verdünnt sind	raue und abrasive Schwämme, Metallwolle; Schleifmittel oder mit Chlor oder gierigen Lösungsmitteln, Kalkschutzmitteln und Aceton. Produkte mit Verdünnern können die Kanten verformen
<b>Oberflächen aus HPL</b>	weiche Baumwoll- oder Mikrofasertücher, die mit Wasser oder Naturprodukten ohne Lösungsmittel angefeuchtet sind. Mit einem weichen Tuch trocknen. Verwenden Sie bei hartnächigen Flecken neutrale Reinigungsmittel, die mit Wasser verdünnt sind	raue und abrasive Schwämme, Metallwolle; Schleifmittel oder mit Chlor oder gierigen Lösungsmitteln, Kalkschutzmitteln und Aceton
<b>Oberflächen aus AROCK®</b>	weiche Baumwoll- oder Mikrofasertücher, die mit Wasser oder Naturprodukten ohne Lösungsmittel angefeuchtet sind. Mit einem weichen Tuch trocknen. Verwenden Sie bei hartnächigen Flecken neutrale Reinigungsmittel, die mit Wasser verdünnt sind	raue und abrasive Schwämme, Metallwolle; Schleifmittel oder mit Chlor oder gierigen Lösungsmitteln, Kalkschutzmitteln und Aceton
<b>Oberflächen aus LACKIERTE GLAS</b>	weiche Baumwoll- oder Mikrofasertücher, die mit Wasser oder Naturprodukten ohne Lösungsmittel angefeuchtet sind. Mit einem weichen Tuch trocknen	raue und abrasive Schwämme, Metallwolle; Schleifmittel oder mit Chlor oder gierigen Lösungsmitteln, Kalkschutzmitteln und Aceton. Vermeiden Sie das Herunterfallen Schwerer Gegenstände und stellen Sie keine heißen Gegenstände darauf
<b>Oberflächen aus SILESTONE</b>	weiche Baumwoll- oder Mikrofasertücher, die mit Wasser oder Naturprodukten. Mit einem weichen Tuch trocknen. Verwenden Sie bei hartnächigen Flecken neutrale Reinigungsmittel, die mit Wasser verdünnt sind	raue und abrasive Schwämme, Metallwolle; Schleifmittel oder mit Chlor oder gierigen Lösungsmitteln, Kalkschutzmitteln und Aceton. Vermeiden Sie das Herunterfallen Schwerer Gegenstände und stellen Sie keine heißen Gegenstände darauf
<b>Oberflächen aus NATURSTEIN</b>	weiche Baumwoll- oder Mikrofasertücher, die mit Wasser oder Naturprodukten. Mit einem weichen Tuch trocknen. Verwenden Sie bei hartnächigen Flecken neutrale Reinigungsmittel, die mit Wasser verdünnt sind	raue und abrasive Schwämme, Metallwolle; Schleifmittel oder mit Chlor oder gierigen Lösungsmitteln, Kalkschutzmitteln und Aceton. Vermeiden Sie das Herunterfallen Schwerer Gegenstände und stellen Sie keine heißen Gegenstände darauf
<b>Oberflächen aus GRES</b>	weiche Baumwoll- oder Mikrofasertücher, die mit Wasser oder Spezifischprodukten. Mit einem weichen Tuch trocknen	raue und abrasive Schwämme, Metallwolle; Schleifmittel oder mit Chlor oder gierigen Lösungsmitteln, Kalkschutzmitteln und Aceton
<b>Oberflächen aus CASTMARBLE</b>	weiche Baumwoll- oder Mikrofasertücher, die mit Wasser oder Spezifischprodukten. Mit einem weichen Tuch trocknen	raue und abrasive Schwämme, Metallwolle; Schleifmittel oder mit Chlor oder gierigen Lösungsmitteln, Kalkschutzmitteln und Aceton
<b>Oberflächen aus TECNORIL</b>	weiche Baumwoll- oder Mikrofasertücher, die mit Wasser oder Spezifischprodukten. Mit einem weichen Tuch trocknen	raue und abrasive Schwämme, Metallwolle; Schleifmittel oder mit Chlor oder gierigen Lösungsmitteln, Kalkschutzmitteln und Aceton
<b>Spiegeloberflächen</b>	weiche Baumwoll- oder Mikrofasertücher, die mit Wasser oder Spezifischprodukten. Mit einem weichen Tuch trocknen	raue und abrasive Schwämme, Metallwolle; Schleifmittel oder mit Chlor oder gierigen Lösungsmitteln, Kalkschutzmitteln und Aceton
<b>MetallOberflächen</b>	weiche Baumwoll- oder Mikrofasertücher, die mit Wasser oder Spezifischprodukten. Mit einem weichen Tuch trocknen	raue und abrasive Schwämme, Metallwolle; Schleifmittel oder mit Chlor oder gierigen Lösungsmitteln, Kalkschutzmitteln und Aceton

## Parte tecnica generale Technical section

## Section technique Technischen Teil

### MANUTENZIONE / USO MAINTENANCE / USE

### MAINTENANCE / USAGE UNTERHALTUNG / NUTZUNG

	DA UTILIZZARE	DA EVITARE
<b>Superfici Laccate</b>	panni morbidi in cotone o microfibra inumiditi con acqua o con prodotti naturali tipo quelli per la pulizia del vetro che non contengono solventi. Asciugare sempre con un panno morbido. Per macchie insistenti usare detergenti neutri diluiti con acqua	spugne ruvide e abrasive, pagliette metalliche; prodotti abrasivi o prodotti contenenti solventi, cloro o acidi, prodotti anticalcare e acetoni
<b>Superfici in Nobilitato</b>	panni morbidi in cotone o microfibra inumiditi con acqua o con prodotti naturali tipo quelli per la pulizia del vetro che non contengono solventi. Asciugare sempre con un panno morbido. Per macchie insistenti usare detergenti neutri diluiti con acqua	spugne ruvide e abrasive, pagliette metalliche; prodotti abrasivi o prodotti contenenti solventi, cloro o acidi, prodotti anticalcare e acetoni; prodotti contenenti diluenti sui bordi possono provocare rammollimenti e deformazioni
<b>Superfici AROCK®</b>	panni morbidi in cotone o microfibra inumiditi con acqua o con prodotti naturali tipo quelli per la pulizia del vetro che non contengono solventi. Asciugare sempre con un panno morbido. Per macchie insistenti usare detergenti neutri diluiti con acqua	spugne ruvide e abrasive, pagliette metalliche; prodotti abrasivi o prodotti contenenti solventi, cloro o acidi, prodotti anticalcare e acetoni
<b>Superfici in ceramica</b>	panni morbidi in cotone o microfibra inumiditi con acqua o con prodotti naturali tipo quelli per la pulizia del vetro che non contengono solventi. Asciugare sempre con un panno morbido. Per macchie insistenti usare detergenti neutri diluiti con acqua	spugne ruvide e abrasive, pagliette metalliche; prodotti abrasivi o prodotti contenenti solventi, cloro o acidi, prodotti anticalcare e acetoni. Evitare la caduta di oggetti pesanti e l'appoggio di oggetti roventi
<b>Superfici in Castmarble</b>	utilizzare panni morbidi in cotone o microfibra inumiditi con acqua o con prodotti specifici. Asciugare sempre con un panno morbido	spugne ruvide e abrasive, pagliette metalliche; prodotti abrasivi o prodotti contenenti solventi, cloro o acidi, prodotti anticalcare e acetoni
<b>Superfici specchio</b>	utilizzare panni morbidi in cotone o microfibra inumiditi con detergenti specifici per vetro/specchio. Asciugare sempre con un panno morbido	spugne ruvide e abrasive, pagliette metalliche; prodotti abrasivi o prodotti contenenti solventi, cloro o acidi, prodotti anticalcare e acetoni
<b>Parti in metallo</b>	utilizzare panni morbidi in cotone o microfibra inumiditi con acqua o con prodotti specifici. Asciugare sempre con un panno morbido	spugne ruvide e abrasive, pagliette metalliche; prodotti abrasivi o prodotti contenenti solventi, cloro o acidi, prodotti anticalcare e acetoni.

**Parte tecnica generale**  
**Technical section**

**Section technique**  
**Technischen Teil**

**MAINTENANCE / USE**

	<b>TO BE USED</b>	<b>TO AVOID</b>
<b>Lacquered surfaces</b>	soft cotton or microfibre cloths damp with water or natural products without solvents. Dry with a soft cloth. For persistent stains use neutral detergents diluted with water	rough and abrasive sponges, metal wool; abrasive products or with chlorine or greedy solvents, anti-limescale products and acetone
<b>Nobilitato surfaces</b>	soft cotton or microfibre cloths damp with water or natural products without solvents. Dry with a soft cloth. For persistent stains use neutral detergents diluted with water	rough and abrasive sponges, metal wool; abrasive products or with chlorine or greedy solvents, anti-limescale products and acetone; products with thinners can deform the edges
<b>AROCK® surfaces</b>	soft cotton or microfibre cloths damp with water or natural products without solvents. Dry with a soft cloth. For persistent stains use neutral detergents diluted with water	rough and abrasive sponges, metal wool; abrasive products or with chlorine or greedy solvents, anti-limescale products and acetone
<b>CERAMIC surfaces</b>	soft cotton or microfibre cloths damp with water or natural products without solvents. Dry with a soft cloth. For persistent stains use neutral detergents diluted with water	rough and abrasive sponges, metal wool; abrasive products or with chlorine or greedy solvents, anti-limescale products and acetone; Avoid falling heavy objects and do not place hot objects on it
<b>CASTMARBLE surfaces</b>	soft cotton or microfibre cloths damp with water or natural products without solvents. Dry with a soft cloth	rough and abrasive sponges, metal wool; abrasive products or with chlorine or greedy solvents, anti-limescale products and acetone
<b>Mirror surfaces</b>	soft cotton or microfibre cloths damp with water or specific products without solvents. Dry with a soft cloth	rough and abrasive sponges, metal wool; abrasive products or with chlorine or greedy solvents, anti-limescale products and acetone
<b>Metal parts</b>	soft cotton or microfibre cloths damp with water or specific products without solvents. Dry with a soft cloth	rough and abrasive sponges, metal wool; abrasive products or with chlorine or greedy solvents, anti-limescale products and acetone

**MAINTENANCE / USAGE**

	<b>UTILISER</b>	<b>ÉVITER</b>
<b>Surfaces lacquées</b>	chiffons doux en coton ou microfibras humides avec de l'eau ou des produits naturels sans solvants. Sécher avec un chiffon doux. Pour les taches persistantes utilisez des détergents neutres dilués avec de l'eau	éponges rugueuses et abrasives, laine de métal; produits abrasifs ou avec du chlore ou des solvants gourmands, des produits anticalcaire et de l'acétone
<b>Surfaces en Nobilitato</b>	chiffons doux en coton ou microfibras humides avec de l'eau ou des produits naturels sans solvants. Sécher avec un chiffon doux. Pour les taches persistantes utilisez des détergents neutres dilués avec de l'eau	éponges rugueuses et abrasives, laine de métal; produits abrasifs ou avec du chlore ou des solvants gourmands, des produits anticalcaire et de l'acétone. Les produits avec des diluants peuvent déformer les bords
<b>Surfaces en AROCK®</b>	chiffons doux en coton ou microfibras humides avec de l'eau ou des produits naturels sans solvants. Sécher avec un chiffon doux. Pour les taches persistantes utilisez des détergents neutres dilués avec de l'eau	éponges rugueuses et abrasives, laine de métal; produits abrasifs ou avec du chlore ou des solvants gourmands, des produits anticalcaire et de l'acétone
<b>Surfaces en CÉRAMIQUE</b>	chiffons doux en coton ou microfibras humides avec de l'eau ou des produits naturels sans solvants. Sécher avec un chiffon doux. Pour les taches persistantes utilisez des détergents neutres dilués avec de l'eau	éponges rugueuses et abrasives, laine de métal; produits abrasifs ou avec du chlore ou des solvants gourmands, des produits anticalcaire et de l'acétone. Évitez de faire tomber des objets lourds et ne placez pas d'objets chauds dessus
<b>Surfaces en CASTAMARBLE</b>	chiffons doux en coton ou microfibras humides avec de l'eau ou des produits spéciaux. Sécher avec un chiffon doux	éponges rugueuses et abrasives, laine de métal; produits abrasifs ou avec du chlore ou des solvants gourmands, des produits anticalcaire et de l'acétone
<b>Surfaces en miroir</b>	chiffons doux en coton ou microfibras humides avec de l'eau ou des produits spéciaux. Sécher avec un chiffon doux	éponges rugueuses et abrasives, laine de métal; produits abrasifs ou avec du chlore ou des solvants gourmands, des produits anticalcaire et de l'acétone
<b>Parties en métal</b>	chiffons doux en coton ou microfibras humides avec de l'eau ou des produits spéciaux. Sécher avec un chiffon doux	éponges rugueuses et abrasives, laine de métal; produits abrasifs ou avec du chlore ou des solvants gourmands, des produits anticalcaire et de l'acétone

## Parte tecnica generale Technical section

## Section technique Technischen Teil

### UNTERHALTUNG / NUTZUNG

	ZU BENUTZEN	ZU VERMEIDEN
<b>Lackierte Oberflächen</b>	weiche Baumwoll- oder Mikrofasertücher, die mit Wasser oder Naturprodukten ohne Lösungsmittel angefeuchtet sind. Mit einem weichen Tuch trocknen. Verwenden Sie bei hartnäckigen Flecken neutrale Reinigungsmittel, die mit Wasser verdünnt sind	raue und abrasive Schwämme, Metallwolle; Schleifmittel oder mit Chlor oder gierigen Lösungsmitteln, Kalkschutzmitteln und Aceton
<b>Oberflächen aus Nobilitato</b>	weiche Baumwoll- oder Mikrofasertücher, die mit Wasser oder Naturprodukten ohne Lösungsmittel angefeuchtet sind. Mit einem weichen Tuch trocknen. Verwenden Sie bei hartnäckigen Flecken neutrale Reinigungsmittel, die mit Wasser verdünnt sind	raue und abrasive Schwämme, Metallwolle; Schleifmittel oder mit Chlor oder gierigen Lösungsmitteln, Kalkschutzmitteln und Aceton. Produkte mit Verdünnern können die Kanten verformen
<b>Oberflächen aus AROCK®</b>	weiche Baumwoll- oder Mikrofasertücher, die mit Wasser oder Naturprodukten ohne Lösungsmittel angefeuchtet sind. Mit einem weichen Tuch trocknen. Verwenden Sie bei hartnäckigen Flecken neutrale Reinigungsmittel, die mit Wasser verdünnt sind	raue und abrasive Schwämme, Metallwolle; Schleifmittel oder mit Chlor oder gierigen Lösungsmitteln, Kalkschutzmitteln und Aceton
<b>Oberflächen aus KERAMIK</b>	weiche Baumwoll- oder Mikrofasertücher, die mit Wasser oder Naturprodukten ohne Lösungsmittel angefeuchtet sind. Mit einem weichen Tuch trocknen. Verwenden Sie bei hartnäckigen Flecken neutrale Reinigungsmittel, die mit Wasser verdünnt sind	raue und abrasive Schwämme, Metallwolle; Schleifmittel oder mit Chlor oder gierigen Lösungsmitteln, Kalkschutzmitteln und Aceton. Vermeiden Sie das Herunterfallen Schwerer Gegenstände und stellen Sie keine heißen Gegenstände darauf
<b>Oberflächen aus CASTMARBLE</b>	weiche Baumwoll- oder Mikrofasertücher, die mit Wasser oder Spezifischprodukten. Mit einem weichen Tuch trocknen	raue und abrasive Schwämme, Metallwolle; Schleifmittel oder mit Chlor oder gierigen Lösungsmitteln, Kalkschutzmitteln und Aceton
<b>SpiegelOberflächen</b>	weiche Baumwoll- oder Mikrofasertücher, die mit Wasser oder Spezifischprodukten. Mit einem weichen Tuch trocknen	raue und abrasive Schwämme, Metallwolle; Schleifmittel oder mit Chlor oder gierigen Lösungsmitteln, Kalkschutzmitteln und Aceton
<b>MetallOberflächen</b>	weiche Baumwoll- oder Mikrofasertücher, die mit Wasser oder Spezifischprodukten. Mit einem weichen Tuch trocknen	raue und abrasive Schwämme, Metallwolle; Schleifmittel oder mit Chlor oder gierigen Lösungsmitteln, Kalkschutzmitteln und Aceton

## IT Assistenza e garanzia

---

TDA Srl garantisce i propri prodotti per 24 mesi a partire dalla data di acquisto secondo le normative Europee vigenti in materia. La garanzia TDA copre esclusivamente i difetti di fabbricazione o di assemblaggio. Eventuali difetti estetici o strutturali dei prodotti vanno segnalati per iscritto, a mezzo email o fax, corredati dal documento d'acquisto e da immagini fotografiche che attestino chiaramente il difetto, prima di procedere con il montaggio dei prodotti, al proprio rivenditore o al servizio post-vendita di TDA. Qualsiasi difetto segnalato ad avvenuto montaggio non potrà essere in alcun modo risarcito.

TDA si impegna ad intervenire tempestivamente nel garantire la riparazione o sostituzione degli elementi riconosciuti difettosi. Non sono assolutamente contemplate eventuali richieste di indennizzo da parte dell'acquirente derivate da disagi, costi aggiuntivi, ecc.

Il personale tecnico di TDA interverrà per riscontrare e riconoscere l'eventuale difetto per poi procedere alla sua risoluzione.

Sono esclusi dal servizio di garanzia TDA:

- danni arrecati ed imputabili al trasporto non comunicati al trasportatore
- rotture dei vetri causate dalla movimentazione manuale o da impatti accidentali durante l'utilizzo
- danni arrecati da installazioni non effettuate "a regola d'arte" secondo le istruzioni di montaggio di TDA
- danni arrecati da interventi sui prodotti effettuati da personale non competente e non autorizzato
- difetti dovuti alla normale usura del prodotto o all'incurezza da parte del fruitore
- difetti o malfunzionamenti riconducibili all'uso di prodotti per la pulizia non idonei da parte del fruitore
- malfunzionamenti riconducibili a cause di forza maggiore
- manomissioni da parte dell'acquirente riscontrate del servizio tecnico

TDA Srl declina ogni responsabilità per danni a persone, animali e/o cose causati da scorrette installazioni o regolazioni, dallo scorretto utilizzo o da mancate manutenzioni periodiche e dalla mancata scrupolosa osservanza di tutta la documentazione allegata al prodotto.

Qualora vengano richiesti interventi di manutenzione, di qualsiasi tipologia essi siano, oltre i tempi coperti da garanzia o che non rispettino i punti sopra elencati, verranno applicate le tariffe da listino convenzionale.

TDA Srl garantisce la disponibilità dei pezzi di ricambio di un prodotto fino a 2 anni dall'uscita di produzione e successivamente fino ad esaurimento delle scorte.

## Servizi pre e post vendita Italia

---

TDA Srl dispone di una rete di CAT (Centri Assistenza Tecnica) affiliati in tutta Italia. I servizi erogati di installazione, assistenza tecnica e manutenzione sono a pagamento secondo il tariffario del CAT affiliato. Il personale impiegato dai CAT è specializzato e costantemente formato per garantire piena soddisfazione sia per l'assistenza che per l'installazione dei prodotti TDA; per conoscere il CAT più vicino consultare il sito **www.tda.it** nell'apposita sezione.

Per richiedere l'intervento dell'assistenza tecnica direttamente a TDA, inviare una email ad **css@tda.it** indicando le generalità dell'installatore, quelle dell'utente ed eventuali fotografie.

## **EN** Warranty and technical support

---

Warranty is valid 24 months after purchase according to the European regulations.

TDA warranty includes manufacturing and assembling faults ONLY.

Aesthetic or functional faults have to be reported in writing, together with the invoice and pictures BEFORE installation.

Any claim after installation will not be considered.

TDA will take prompt actions to check the damage and solve the problem.

TDA technical team will check and confirm (or not) the above fault and will take actions accordingly.

The warranty does not include:

damages occurred during transport which have not been reported to the carrier

glass crash due to lack of attention in handling or during installation

wrong installation in spite of written instructions

wrong actions made by unqualified people

wrong actions taken by consumers and detected and confirmed by TDA technical service

normal wear and tear

TDA is not responsible for damages occurred to people, animals and/or things which are caused by faulty installation or wrong maintenance.

Should technical assistance be needed after warranty expires, the costs (price list) will be charged to consumer.

Spare parts are available also in case a product is dismissed, up to 2 years after discontinuance.

## FR Assistance et garantie

---

TDA Srl garantit ses produits pendant 24 mois à compter de la date d'achat conformément à la réglementation européenne en vigueur. La garantie TDA couvre les défauts de fabrication ou d'assemblage. Les défauts esthétiques ou structurels des meubles doivent être signalés à votre revendeur par écrit, par email ou par télécopieur, accompagnés du document d'achat et de photos attestant clairement le défaut, avant de procéder à l'installation des meubles. Tout défaut signalé après installation, ne peut pas être accepté.

TDA se charge d'intervenir dans les meilleurs délais pour assurer la réparation ou le remplacement des pièces reconnues défectueuses. La garantie ne couvre pas toute réclamation par l'acheteur dérivé de la gêne occasionnée, des coûts supplémentaires, etc. TDA se réserve d'intervenir pour détecter et reconnaître le défaut déclaré et en suite procéder pour la résolution du problème.

la garantie TDA ne couvre pas:

- Les dommages causés par le transport et non communiqués au transporteur à réception
- La casse du verre causée par une manipulation manuelle ou par des chocs accidentels pendant l'utilisation
- Les dommages causés par des installations non effectuées " dans les règles de l'art", selon les instructions d'installation de TDA.
- Les dommages dus aux interventions sur les meubles effectuées par du personnel non qualifié et non autorisé
- Les défauts dus à l'usure normale du produit ou manque d'entretien préconisé
- Les défauts liés à l'utilisation de produits de nettoyage agressifs et non adaptés
- Anomalies dues à la force majeure
- modification du produit

TDA Srl décline toute responsabilité pour les dommages aux personnes, aux animaux et / ou des biens causés par une installation ou un réglage incorrect, une utilisation incorrecte ou du manque d'entretien périodique et le non-respect de toute la documentation jointe au produit.

Toute intervention en SAV, au delà de la période de garantie ou pour les dysfonctionnements non couverts par la garantie, sera facturée selon tarif en vigueur.

TDA Srl garantit la disponibilité des pièces de rechange d'un produit jusqu'à 2 ans à partir de l'arrêt de production et au-delà, jusqu'à épuisement des stocks.



## DE Service und Garantiebedingungen

---

TDA Srl gewährleistet alle Produkte für 24 Monate ab Rechnungsdatum gemäß den geltenden europäischen Rechtsvorschriften. Die Garantie erstreckt sich ausschließlich auf Produktionsfehler und Montagemängel. Alle ästhetische Mängel, sowie Strukturdefekten müssen vor dem Einbau fotografisch dokumentiert werden und schriftlich durch geeignete Nachweise per Fax oder E-mail dem entsprechenden Verteiler oder dem zuständigen TDA Kundendienst übermittelt werden. Alle Mängel, die nach dem Einbau mitgeteilt werden, dürfen nicht Gegenstand einer Entschädigung sein.

TDA verpflichtet sich unverzüglich Maßnahmen zu ergreifen, damit die defekte Bestandteile repariert oder ersetzt gemäß der Garantiebedingungen werden. Keine Entschädigung für zusätzlichen Nebenkosten ist definitiv vorgesehen. Der TDA Kundendienst wird darauf eingreifen und wird alle notwendige Maßnahmen treffen um die Mängel zu prüfen und beheben.

Die folgenden Situationen sind nicht durch die TDA Dienstleistung gedeckt:

- Transportbeschädigungen, wenn ohne ausreichende Belege des Spediteurs mitgeteilt.
- Bruch der Glasscheiben aufgrund der manuellen Handhabung der Verpackungen.
- Schäden, die durch Installationsfehler oder durch die Nichteinhaltung der TDA Montageanleitung verursacht werden.
- Schäden, die durch Eingriffe von unbefügtem Personal verursacht werden.
- Mängel, die auf den normalen Verschleiß des Produkts oder auf Wartungsmangel zurückzuführen sind.
- Schäden oder Funktionsstörungen, die auf die Verwendung von nicht geeigneten Reinigungsmitteln zurückzuführen sind.
- Funktionsfehler die aus Gründen höherer Gewalt zurückzuführen sind.
- Mißbräuchliche Eingriffe des Endverbrauchers, die von dem TDA Kundendienst festgestellt werden.

TDA Srl übernimmt keine Verantwortung oder Haftung für Personen, Tiere- und Sachschäden, die auf Installationsfehler, falsche Einstellungen, fehlerhafte Verwendung, mangelhafte Pflege, sowie auf die Nichteinhaltung der Vorschriften laut der Produktdokumentation zurückzuführen sind.

Werden über die Garantiezeit Instandhaltungen jeder Art beantragt, wird TDA Srl die entsprechenden Kosten laut der gültigen Preisliste berechnen.

Für alle Auslaufprodukte gewährleistet TDA Srl die Verfügbarkeit auf Lager der Ersatzteile über einen Zeitraum von 2 Jahren. Die entsprechenden Ersatzteile bleiben auf Lager bis zur Erschöpfung der Bestände.

## IT Condizioni generali di vendita e trasporto

### Listino Prezzi 20 / €

#### PREZZI IVA ESCLUSA

Le misure sono in cm

	4.3	Ordine e/o modifiche di ordini dovranno essere comunicati/confermati per iscritto dall'Acquirente tramite telefax o e-mail.
	4.4	Ordini di importo netto inferiore ad Euro 250,00 (IVA esclusa) saranno gravati di un addebito di Euro 10,00 netti per spese forfetarie di gestione ordine.
	4.5	TDA Srl si riserva il diritto di valutare la fattibilità di Prodotti su specifica richiesta dell'Acquirente, di stabilirne i prezzi, le modalità e i termini di consegna.
	4.6	Non si accettano annullamenti d'ordine per Prodotti dedicati o realizzati su specifica richiesta dell'Acquirente.
	5.1	<b>5. GARANZIA DI CONFORMITA' PRODOTTI</b> TDA Srl garantisce i propri prodotti per 24 mesi a decorrere dalla data d'acquisto e comunque entro il limiti ed ai sensi del decreto legislativo n.206 del 06.09.2005 (Codice del Consumo) La garanzia copre esclusivamente vizi e difetti di fabbricazione o assemblaggio. Difetti estetici o strutturali devono essere comunicati per iscritto a TDA Srl solo ed esclusivamente prima dell'installazione, allegando i documenti di acquisto e di prodotto.
1.1		<b>1. VALIDITA' E DIRITTO DI MODIFICA</b> Qualsiasi contratto sottoscritto da TDA Srl per la vendita dei propri prodotti indicati nel listino prezzi (di seguito i "Prodotti" e ciascuno di essi il "Prodotto") a qualunque cliente (di seguito l'"Acquirente") sarà soggetto alle presenti condizioni generali di vendita. In caso di discordanza tra quanto previsto dalle presenti condizioni generali di vendita e quanto pattuito in specifici accordi tra TDA Srl e l'Acquirente, prevarrà quanto previsto in detti specifici accordi.
1.2		TDA Srl si riserva il diritto di modificare e/o variare le presenti condizioni generali di vendita nonché il listino prezzi.
2.1		<b>2. CARATTERISTICHE DEI PRODOTTI</b> Nei singoli contratti di vendita stipulati da Tda Srl, le eventuali informazioni riguardanti i Prodotti ed il loro uso sono vincolanti per le parti, salvo che le parti non abbiano previsto diversamente nel singolo contratto di vendita.
2.2		Eventuali informazioni o dati sulle caratteristiche e/o specifiche tecniche dei Prodotti contenute nel listino prezzi sono indicative e non vincolanti. I Prodotti vengono realizzati con diversi materiali: TDA Srl si riserva il diritto di apportare ai Prodotti le modifiche che, senza alterarne le caratteristiche essenziali e di imballo, dovessero risultare necessarie.
3.1		<b>3. PREZZO E TERMINI DI PAGAMENTO</b> Ove non vi sia stato uno specifico accordo tra TDA Srl e l'Acquirente in merito al prezzo dei Prodotti, si applicherà per ciascun Prodotto il relativo prezzo di listino in vigore al momento della conclusione del contratto. I prezzi per la vendita dei Prodotti indicati nel listino prezzi si intendono franco Magazzino Centrale o franco fabbrica, IVA e ogni altra tassa o imposta esclusa.
3.2		Qualora l'Acquirente non effettui il pagamento di quanto dovuto entro il termine pattuito, TDA Srl potrà, a propria discrezione e senza alcun preavviso, sospendere le consegne in corso relativamente ai Prodotti non ancora consegnati e/o annullare le ulteriori consegne. A pagamento avvenuto, i tempi di spedizione degli ordini rimasti in sospeso saranno ricalcolati, a far data dal pagamento stesso, in base ai termini di produzione indicati nel listino prezzi. I pagamenti dei Prodotti già consegnati non saranno subordinati al completamento dell'ordine.
3.3		Senza alcun pregiudizio per gli ulteriori rimedi consentiti dalla legge e dalle presenti condizioni generali di vendita, fatto salvo il diritto al risarcimento dei danni, TDA Srl si riserva il diritto di applicare tassi di mora su pagamenti ritardati a decorrere dalla data in cui sia maturato il diritto di pagamento, in attuazione dal Decreto Legislativo n°231/2002 e secondo gli aggiornamenti comunicati periodicamente dal Ministero dell'Economia e delle Finanze, senza necessità di formale costituzione in mora.
3.4		TDA Srl ha diritto al risarcimento dei costi sostenuti per l'eventuale recupero delle somme non tempestivamente corrispostegli, come previsto dal Decreto Legislativo n°231 del 2002.
3.5		Il prezzo pattuito, salvo ove diversamente indicato, rimane invariato fino alla data di spedizione indicata nella conferma d'ordine. Se, per richiesta dell'Acquirente o per motivi non imputabili a TDA Srl, la data di spedizione viene posticipata, TDA Srl si riserva di rivedere il prezzo applicando all'Acquirente eventuali aumenti e/o spese di sosta e magazzinaggio nel frattempo intervenuti.
3.6		I pagamenti devono essere effettuati esclusivamente a favore di TDA Srl Via Circonvallazione, 1 San Gervasio B.no. Qualora l'Acquirente utilizzi per le rimesse di denaro: assegni, cambiali, ricevute od altri strumenti bancari, tali pagamenti, ovunque fatti, si intendono effettuati presso la Venditrice e saranno imputati secondo le regole dell'art.1194 del Codice Civile. Ogni altro pagamento dovrà essere fatto esclusivamente ad incaricati della Venditrice muniti di mandato ad incassare e rilasciare quietanza.
4.1		<b>4. ACCETTAZIONE DEGLI ORDINI</b> Gli ordini verranno considerati validi solo se effettuati per iscritto e ricevuti da TDA Srl, via telefax o via e-mail, agli indirizzi dalla stessa comunicati.
4.2		Nessun contratto sarà concluso tra TDA Srl e l'Acquirente fino a che non vi sia stata accettazione scritta dell'ordine dell'Acquirente da parte di TDA Srl, tramite conferma d'ordine giunta a conoscenza dell'Acquirente.
	5.2	La garanzia impegna TDA Srl solo alla riparazione e/o alla sostituzione degli elementi difettosi: sono pertanto escluse ulteriori pretese da parte dell'Acquirente, ed esclude qualsiasi indennizzo derivato dal disagio, od onere o costo relativo accessorio. La non conformità dovrà essere riconosciuta solo da parte di personale autorizzato da TDA Srl
	5.3	Sono comunque esclusi dalla garanzia i seguenti casi: - Se il difetto è riconducibile al trasporto. - Rotture di tutte le parti in vetro temperato, in particolare causate da impatto, urti durante il trasporto, movimentazione manuale degli elementi in fase di installazione e impatti accidentali durante l'utilizzo. - Se l'installazione non è stata eseguita dettagliatamente secondo istruzioni TDA Srl - Se il vizio di funzionamento è conseguente ad un intervento sul prodotto non autorizzato. - Se il funzionamento difettoso è conseguente alla normale usura del prodotto, alla negligenza o incuranza da parte dell'Acquirente nel rispetto delle indicazioni allegate al prodotto. - Se il difetto è riconducibile all'utilizzo di detergenti abrasivi, a base acida, o prodotti non adatti alla pulizia di superfici laccate, verniciate, anodizzate e vetrose. Si consiglia l'utilizzo di articoli per la cura del Prodotto a marchio TDA Srl - Se il funzionamento difettoso è conseguente a forze maggiori. - Manomissione del prodotto da parte dell'Acquirente.
	5.4	TDA Srl declina qualsiasi responsabilità per eventuali danni e persone, animali o cose causati da errori di installazione, di regolazione, imperfetto utilizzo o la mancata osservanza di tutte le prescrizioni indicate nella documentazione allegata al prodotto.
	5.5	TDA Srl si riserva il diritto di apportare modifiche tecniche ed estetiche ai propri prodotti in qualsiasi momento senza preavviso, ivi comprese modifiche a volume e peso.
	6.1	<b>6. RESA E SPEDIZIONE PRODOTTI</b> Il destinatario è obbligato a controllare la merce in arrivo e a contestare subito gli eventuali danni direttamente al trasportatore che ne è responsabile. E' diritto del destinatario e dovere del trasportatore controllare la spedizione (senza aprire l'imballo) e apporre le eventuali riserve specifiche sul DDT dal trasportatore e quello TDA Srl. La sola dicitura generica: "RISERVA DI CONTROLLO" non è valida. Danno occulto: nel caso di colli rovinati, solo esternamente, questi possono essere ritirati indicando sui DDT (documento di trasporto) del trasportatore e di TDA Srl la clausola "RISERVA DI CONTROLLO", specificando la motivazione per cui si è posta la riserva, come previsto dalla normativa vigente in materia di trasporto. Nel caso di rotture accertate, il destinatario deve darne comunicazione scritta a mezzo raccomandata a TDA Srl e per conoscenza al trasportatore spedendola entro e non oltre 8 giorni dal ricevimento merce. Danno accertabile: nel caso di danno evidente ed accertabile anche dal trasportatore, deve essere posta una riserva sul DDT del trasportatore e di TDA Srl indicando chiaramente quantità e codici danneggiati ed il tipo di danno esterno ed interno riscontrato. Copia dei DDT devono essere inviati all'ufficio clienti TDA Srl che successivamente darà le opportune disposizioni per l'eventuale sostituzione e reso del materiale.
	6.2	Da quanto previsto ai paragrafi 6.2 e 6.3. TDA Srl non riconoscerà alcun rimborso per danni o rotture riscontrate.
	6.3	
	6.4	

6.5	Nessun articolo può essere reso senza l'autorizzazione scritta da TDA Srl: i resi autorizzati dovranno pervenire in porto franco al ns. stabilimento utilizzando il trasportatore ed il numero di riferimento comunicati da TDA Srl Il numero di riferimento deve essere riportato sul documento di trasporto. Se nell'accurato controllo TDA Srl si riscontrassero incurie dell'Acquirente, il materiale reso sarà gravato di un importo per la copertura delle spese generali oltre ad eventuali spese di ripristino a nuovo.	11.3	Qualora la sospensione dovuta a forza maggiore duri più di 6 settimane, ciascuna parte avrà il diritto di risolvere il presente contratto, previo un preavviso di 10 giorni, da comunicarsi alla controparte per iscritto.
	7. TERMINI DI SPEDIZIONE DEI PRODOTTI		12. PROPRIETA' INDUSTRIALE E INTELLETTUALE
7.1	La data di spedizione dei Prodotti indicata sul piano di evasione è sempre indicativa e non vincolante, salvo diversamente pattuito per iscritto.	12.1	L'Acquirente riconosce che i documenti, disegni, marchi, nomi, dati ed informazioni, (sia in forma cartacea, sia su supporto elettronico) relativi ai Prodotti sono di esclusiva proprietà di TDA Srl e non possono essere divulgati, alterati, modificati, rimossi o cancellati in qualsiasi modo.
7.2	Qualora TDA Srl preveda di non essere in grado di spedire i Prodotti nella data di spedizione indicata sul piano di evasione, ne darà avviso all'Acquirente indicando, ove possibile, la nuova data di spedizione prevista. Ove il ritardo imputabile a TDA Srl superi le 6 settimane, l'Acquirente potrà risolvere il contratto relativamente ai Prodotti di cui la spedizione è ritardata, con un preavviso di 10 giorni, da comunicarsi per iscritto via telefax a TDA Srl, con esclusione di qualsiasi altro rimedio o danno.	12.2	L'Acquirente si impegna a non riprodurli/divulgarli a terzi ed a limitarne l'uso allo specifico Prodotto acquistato.
7.3	Non si considera imputabile a TDA Srl l'eventuale ritardo dovuto a cause di forza maggiore o caso fortuito, atti, omissioni dell'Acquirente (ad esempio mancata comunicazione di indicazioni necessarie per la fornitura dei Prodotti).	12.3	L'Acquirente ha il limitato diritto di uso dei marchi, nomi o altri segni distintivi così come di ogni altro diritto di privativa industriale o know-how produttivo e commerciale incorporato nei Prodotti e che rimane di proprietà esclusiva di TDA Srl, al solo e limitato fine di utilizzare o di rivendere i Prodotti al pubblico. Ogni diverso utilizzo della proprietà intellettuale di TDA Srl da parte dell'Acquirente, se non espressamente concesso per iscritto da TDA Srl, si intenderà violazione da parte dell'Acquirente dei predetti diritti esclusivi di TDA Srl, anche sotto il profilo della responsabilità contrattuale e, come tale, sarà propriamente perseguito.
7.4	Nel caso in cui, per cause non imputabili a TDA Srl, TDA Srl stessa risultasse temporaneamente o permanentemente impossibilitata ad effettuare la spedizione, TDA Srl ne darà informazione all'Acquirente e sarà sollevata dagli obblighi di spedizione per tutta la durata dell'impedimento e per tutto il tempo in cui si protraggono gli effetti ad esso conseguenti, nonché da ogni obbligo di risarcimento danni per ritardo o inadempimento nei confronti dell'Acquirente.	13.1	13. INFORMATIVA Il Regolamento (UE) 679/2016 stabilisce che il soggetto interessato debba essere preventivamente informato in merito all'utilizzo dei dati che lo riguardano e che il trattamento di dati personali è ammesso solo con il consenso espresso del soggetto interessato, salvo i casi previsti dalla legge.
7.5	In ogni caso, e fatto salvo quanto sopra previsto per il caso di risoluzione del contratto, il risarcimento del danno effettivo subito dall'Acquirente per ritardare spedizioni imputabili a TDA Srl non potrà eccedere un importo massimo corrispondente al 5% del prezzo netto dei Prodotti spediti in ritardo. Sono comunque esclusi da ogni risarcimento i danni indiretti, consequenziali o punitivi.	13.2	Titolare del trattamento. Il Titolare del trattamento dei dati è TDA S.r.l., via Circonvallazione, 1 – 25020, San Gervasio Bresciano (BS) – Italia, Tel. 030 9926311, Fax 030 9926312, Mail info@tda.it
7.6	Il pagamento delle somme sopra indicate esclude qualsiasi ulteriore risarcimento del danno per mancata o ritardata spedizione dei Prodotti	13.3	Finalità del trattamento. I dati personali sono trattati nell'ambito della normale attività dell'azienda TDA S.r.l. per finalità relative a: . Adempimento di obblighi fiscali o contabili . Gestione della clientela (amministrazione della clientela, amministrazione di contratti, ordini e fatture, gestione delle prenotazioni) . Gestione dei fornitori (amministrazione dei fornitori, amministrazione di contratti, ordini, fatture, selezione in rapporto alle necessità dell'impresa) . Preparazione di preventivi, gestione ed esecuzione di contratti
8.1	8. RECLAMI E' inteso che eventuali reclami o contestazioni, riguardanti una parte dei Prodotti consegnati o una singola spedizione di Prodotti, non danno diritto all'Acquirente di sospendere o comunque ritardare i pagamenti dei Prodotti oggetto di contestazione, nè, tanto meno, di altre forniture.	13.4	Destinatari o categorie di destinatari ai quali i dati personali possono essere comunicati. I dati potranno essere trasmessi a società o persone esterne che svolgono attività strettamente connesse e strumentali alla gestione del rapporto commerciale, quali: . istituti di credito e società di transazioni finanziarie . consulenti e liberi professionisti, singoli ed associati
9.1	9. FORO COMPETENTE I contratti tra TDA Srl e l'Acquirente sono retti dalla legge italiana, con espressa esclusione di quanto previsto dalla Convenzione di Vienna del 1980 sulla vendita internazionale di merci.	13.5	Periodo di conservazione. I dati personali saranno conservati per una durata massima di 10 anni dall'ultima fatturazione e/o fino alla conclusione del rapporto contrattuale e oltre solo per l'adempimento di obblighi fiscali e contabili
9.2	Per qualsiasi controversia tra le parti, relativa ai rapporti di compravendita o fornitura, alla loro instaurazione, esecuzione o cessazione, sarà esclusivamente competente il Foro di Milano - Italia.	13.6	Diritti dell'interessato. L'interessato ha diritto di ottenere dal Titolare la conferma che sia o meno in corso un trattamento di dati personali che lo riguardano e in tal caso ha il diritto di: . ottenere l'accesso ai dati personali, chiederne la rettifica, la cancellazione, la limitazione o di opporsi al loro trattamento; . ricevere in un formato strutturato, di uso comune e leggibile da dispositivo automatico i dati personali che lo riguardano e di trasmettere tali dati a un altro Titolare del trattamento (portabilità dei dati); . essere informato dell'esistenza di un processo decisionale automatizzato, compresa la profilazione; . revocare il consenso in qualsiasi momento, senza pregiudicare la liceità del trattamento basato sul consenso prestato prima della revoca; . proporre reclamo all'Autorità di controllo
9.3	Tuttavia, in deroga a quanto sopra stabilito, TDA Srl ha comunque la facoltà di portare la controversia davanti al giudice competente presso la sede dell'Acquirente.		
10.1	10. ECO CONTRIBUTO RAEE I prezzi si intendono comprensivi da eco contributo RAEE.		
11.1	11. FORZA MAGGIORE Ciascuna parte potrà sospendere l'esecuzione dei propri obblighi contrattuali quando tale esecuzione sia resa impossibile o irragionevolmente onerosa da un impedimento imprevedibile indipendente dalla sua volontà, quale ad esempio sciopero, boicottaggio, serrata, incendio, guerra (dichiarata o non) guerra civile, sommosse e rivoluzioni, requisizioni, embargo, interruzioni di energia, ritardi nella consegna di componenti o materia prima.		
11.2	La parte che desidera avvalersi della presente clausola dovrà comunicare immediatamente per iscritto all'altra parte il verificarsi e la cessazione delle circostanze di forza maggiore.		

## EN General sales and transport conditions

### Price List 20 / €

Prices VAT excluded  
Sizes in cm

	<b>1. VALIDITY AND MODIFICATION RIGHT</b>		
1.1	Any agreement subscribed by TDA srl for the sale of the products mentioned on the price list (hereinafter the "Products" and each of them the "Product" ) to any consumer (hereinafter referred to as "Buyer") will be subject to the present general sales conditions.	5.4	- if defect is due to the use of abrasive detergents or cleaning products not suitable for glass, anodized, laquered or varnished surfaces. - if defective functioning is due to "force majeure" reasons - purchaser manumission of the product TDA Srl declines any responsibility for possible damages caused by bad installation or adjustments errors, incorrect use or no observance of all prescriptions indicated in product enclosed documents
1.2	TDA srl can amend the present general sales conditions as well as the price list without notice.	5.5	TDA srl reserves the full right to technically and aesthetically modify the Product at anytime and without previous notice, including changes in volume and weight.
	<b>2. PRODUCTS' FEATURES</b>		
2.1	In each sales agreement between TDA srl and the Buyer, all information concerning the Products shall be binding for both parties, except for specific written amendments.	6.1	<b>6. SHIPMENT AND PRODUCTS RETURN</b> Deliveries must be immediately inspected, in case of wrong items, and/or shortages, and/or any defect, have ot be reported to the forwarder which is the only responsible for it. It is in the right of the receiver and the duty of the forwarder to control the delivery (without opening the package). A formal making specific notification on the delivery notes, the generic written sentence is not sufficient.
2.2	Any technical information concerning the Products are indicative and not binding. The Products are made of different materials: TDA srl can make necessary improvements to the Products, keeping the basic characteristics and packaging unchanged.	6.2	Hidden damage: if on delivery, the goods show obvious packaging defects, they can be withdrawn, but the receiver is obliged to note the defects on the PoD marking them with "subject to inspection" and specifying the reasons, as stated in the current EU regulations. The claim for damages has to be sent to TDA Srl in writing within 7 days from delivery.
	<b>3. PRICE AND PAYMENT TERMS</b>		
3.1	The current pricelist will be applied at the moment of signature of the Sales agreement. Prices are intended to be ex-works.		
3.2	In case of unsolved payment, TDA srl will stop deliveries of outstanding orders. The delivery time of the pending order will be recalculated, starting from the payment date according to standard timings expressed in this document. Payments for Products already delivered will not be subject to completion of the order.	6.3	Verified damage: in case of evident damage verified by the receiver and the forwarder, the damage evidence must be duly marked on PoD, indicating very clearly the quantity and the damaged product codes, checking if the damage is on the internal or external side. A further copy of PoD must be sent to TDA srl customer service that will arrange the possible replacement upon reception of the damaged goods.
3.3	TDA srl has the right to calculate accruals on pending payments according to EU Directives.		
3.4	The agreed price, is valid until the delivery date as per order confirmation. If the delivery date is postponed, upon request of the Buyer or for reasons not depending on TDA srl, TDA srl can charge additional storage costs to the Buyer.	6.4	Unlike what is clearly specified on the paragraphs 6.2 and 6.3, TDA srl will not recognize any refund for the damage or breakage
	<b>4. ORDER ACCEPTANCE</b>	6.5	No item can be returned without TDA Srl written permission. Authorized returns must be sent to our warehouse without charging transport costs, using TDA srl courier indicating the reference number.
4.1	Orders will be considered valid only if made in writing.		
4.2	Any Sales Agreement between TDA srl and the Buyer will be accepted by TDA srl only in writing.		
4.3	Order and/or amendments to orders shall be confirmed by the buyer in writing.	7.1	<b>7. DELIVERY TERMS</b> The delivery date as per order confirmation is not binding unless differently agreed by the Parties in writing.
4.4	For orders value less than € 250,00 net ( VAT excluded) TDA will charge additional € 10,00 (excluding VAT) for transport costs.	7.2	Where TDA srl is not in the condition to ship punctually, TDA Srl shall give notice to the Buyer, adding, if possible the new delivery date. If TDA Srl delay exceeds 6 weeks, the Buyer can terminate the commercial agreement, with 10 days written notice.
4.5	TDA srl will decide upon feasibility of Customized Products and will fix prices and delivery terms.	7.3	Any delay due to "force majeure" or unforeseen events or incorrect delivery information from the Buyer is not considered TDA srl responsibility.
4.6	Cancellation of special products orders will not be accepted.	7.4	In case, for reasons independent from TDA Srl, shipment were not possible, TDA Srl will inform the Buyer and will decline any responsibility for the delay.
	<b>5. PRODUCT COMPLIANCE</b>	7.5	In any case, and except in case of contract termination, the compensation for loss occurred for delays in deliveries due to TDA srl responsibility will not exceed a maximum the amount equal to 5% of the net value of the above order.
5.1	TDA srl warranty is 24 months valid according to the Eu Directives. It covers manufacturing and components faults only. Claims must be forwarded to TDA srl in writing and before installation, adding purchasing documents, pictures etc	7.6	The payment of the above amount will not be followed by any other reimbursement.
5.2	TDA Srl warranty will cover the replacement of faulty elements. TDA srl technical team will check the claimed damage before giving authorization.		
5.3	TDA srl warranty will not cover the following: - if defect has reference to transport - tempered glass parts crashes installation is not performed properly according to TDA srl instructions; - if functioning defect is due to unauthorized technical intervention on product - if defective functioning is due to normal usury, ot to the purchaser negligence or carelessness following product indication	8.1	<b>8. COMPLAINTS</b> It is agreed that any complaints or disputes concerning any part of the delivered Products or a single shipment of Products, do not entitle the Buyer to suspend or delay the payment of the order or of new orders.

	9. JURISDICTION		
9.1	Agreements between TDA Srl and the Buyer are ruled by Italian law, with the exclusion of what required by the Wien Convention of 1980 on the international sale of goods.		. Customer management (customer administration, contract administration, orders and invoices, reservation management) . Supplier management (supplier administration, contract administration, orders, invoices, selection in relation to the company's needs) . Preparation of cost estimations, management and execution of contracts
9.2	For any dispute between the parties relating to sale or supply relations, to their establishment, performance or termination, shall have as exclusive jurisdiction the Court of Milan – Italy	13.4	Addresses and addresses' categories to whom personal data can be communicated. The data can be transmitted to a company or external persons who carry out instrumental activities strictly connected with the management of the commercial relationship, such as: . financial institutions and financial transaction companies . advisors and legal professionals, individual or associated
9.3	However, notwithstanding the provision above, TDA srl still has the power to bring the dispute before the competent court at the site of the Buyer.		
	10. WEEE CONTRIBUTION		
10.1	The Prices do not include the WEEE contribution	13.5	Retention period Personal data will be stored for a maximum duration of 10 years from the last invoicing and / or until the conclusion of the contractual relationship and beyond only for the fulfillment of fiscal and accounting obligations
	11. FORCE MAJEURE		
11.1	Either party may suspend performance of its contractual obligations when such performance is made impossible or unreasonably onerous by an unforeseeable obstacle beyond its control, such as strike, boycotting, lockouts, fire, war (declared or not), power interruptions, delays in delivery of components or materials.	13.6	Rights of the data subject The data subject has the right to obtain from the Data Controller confirmation that he is or is not undergoing treatment of personal data concerning him; in this case he has the right to: obtain access to personal data, request rectification, cancellation, limitation or oppose their processing; receive, in a structured, machine-readable and commonly used format, personal data concerning him and to transmit such data to another Data Controller (data portability); be informed of the existence of an automated decision-making process, including profiling; revoke the consent at any time, without prejudice to the lawfulness of the treatment based on the consent given prior to the revocation; submit a complaint to the Supervisory Authority
11.2	The party wishing to make use of this clause must notify immediately in writing to the other part the occurrence and cessation of the circumstances of force majeure.		
11.3	If the suspension due to force majeure lasts more than 6 weeks, each party shall be entitled to terminate this contract, with 10 days prior notice, to be notified to the other party in writing.		
	12. INDUSTRIAL AND INTELLECTUAL PROPERTY		
12.1	The Buyer acknowledges that the documents, drawings, logos, names, data and information (both in paper form, either in electronic form) are exclusive property of TDA srl and cannot be disclosed, altered, modified, removed or erased in any way.	13.7	Nature of data and consequence of the failure to notify Without the processing and communication of data of a compulsory nature for the described purposes, the requested services and / or products, in whole or in part, cannot be provided to the interested party.
12.2	The Buyer agrees not to reproduce/disclose to third parties and to restrict their use to the specific Product purchased.		
12.3	The Buyer shall have the limited right to use trademarks, names or other distinguishing marks as well as any other industrial executive right or manufacturing and commercial know-how associated with the goods, which remains exclusive property of TDA Srl, to the sole and limited purpose to utilize or resell the goods to the public. Any other use of the TDA Srl intellectual property by the Buyer, unless expressly, granted in writing by TDA Srl, will be considered an infringement of the TDA Srl exclusive rights by the Buyer, also in terms of contractual liability and, as such, will be prosecuted.		
	13. NOTICE		
13.1	Definition The (EU) Regulation 679/2016 establishes that the interested party must be informed in advance about the use of data concerning him and that the processing of personal data shall be authorised only with the express consent of the subject concerned, except in circumstances provided for by law.		
13.2	Data controller The Data controller is TDA S.r.l., via Circonvallazione, 1 – 25020, San Gervasio Bresciano (BS) – Italia, Tel. 030 9926311, Fax 030 9926312, Mail info@tda.it		
13.3	Purposes of the processing Personal data are processed as part of the normal activity of the company TDA S.r.l. for purposes relating to: . Fulfillment of tax or accounting obligations		



## FR Conditions générales de vente et de transport

### PRIX H.T.

Les dimensions sont indiquées en cm

1. VALIDITE ET DROIT DE MODIFICATION
- 1.1 Tout contrat souscrit par TDA S.r.l. pour la vente de ses produits répertoriés dans ses tarifs (ci-après les "Produits") à tout client (ci-après l'"Acheteur" ou "Client") est soumis aux présentes conditions générales de vente. En cas de désaccord entre ce qui est prévu sur les présentes conditions générales de vente et ce qui est négocié dans des accords spécifiques entre TDA S.r.l. et l'Acheteur, prévaudra ce qui a été négocié dans des accords spécifiques.
- 1.2 TDA S.r.l. se réserve le droit de modifier et/ou varier les présentes conditions générales de vente ainsi que ses tarifs.
2. CARACTERISTIQUES DES PRODUITS
- 2.1 Dans tout contrat de vente stipulé par TDA S.r.l., les éventuels renseignements concernant les Produits et leur utilisation, engagent les deux parties sauf indication contraire stipulée expressément dans le contrat de vente.
- 2.2 Les éventuelles informations ou données sur les caractéristiques des Produits répertoriés dans les tarifs sont données à titre indicatif et sans engagement. Les produits sont réalisés à partir de plusieurs matériaux: TDA S.r.l. se réserve le droit d'apporter des modifications qui pourraient s'avérer nécessaires ou opportunes, sans altérer les caractéristiques essentielles et les emballages des Produits.
3. PRIX ET CONDITIONS DE PAIEMENT
- 3.1 Sauf indication contraire d'un accord spécifique entre TDA S.r.l. et l'Acheteur à propos du prix des Produits, le prix appliqué est le prix du tarif en vigueur au moment de la conclusion du contrat de vente.
- 3.2 En cas de retard de règlement de la part de l'Acheteur, TDA S.r.l. se réserve le droit, sans aucun préavis, de suspendre toute livraison en cours et/ou d'annuler toute livraison à venir. A réception du règlement, les délais de livraison des commandes suspendues seront recalculés sur la base des délais de fabrication indiqués dans les tarifs. Le paiement de Produits déjà livrés ne peut en aucun cas être subordonné à la livraison d'éventuels produits restants à livrer.
- 3.3 Toute prorogation d'échéance, avec ou sans l'accord de TDA, entrainera, conformément aux dispositions légales, la mise en charge du client d'intérêts de retard calculés selon la directive communautaire 2000/35/CE. En outre, tous les frais entraînés par les retards de paiement, notamment ceux de recouvrement et de contentieux, sont à la charge du Client défaillant.
- 3.4 Le prix négocié, sauf indication contraire, reste inchangé jusqu'à la date de livraison indiquée sur l'accusé de réception de la commande. Toutefois, pour faire suite à la demande de l'Acheteur ou pour motifs non imputables à TDA S.r.l., si la date de livraison est reportée, TDA S.r.l. se réserve le droit de modifier le prix à la hausse notamment pour tenir compte d'éventuels frais de stockage non prévus au moment de la vente.
4. ACCEPTATION DES COMMANDES
- 4.1 Les commandes sont considérées valables seulement si stipulées par écrit et reçues par TDA S.r.l., par fax ou courriel aux adresses en vigueur.
- 4.2 Le contrat de vente n'est parfait qu'après acceptation écrite de la commande par TDA S.r.l., concrétisée par l'envoi d'un accusé de réception de commande à l'Acheteur.
- 4.3 Toute commande et/ou modification de commande de la part de l'Acheteur doit être communiquée/confirmée par écrit par fax ou courriel.
- 4.4 À les commandes dont le montant net est inférieur à 250 Euro HT donneront lieu à la mise en charge d'une participation aux frais de gestion de commande de 10 Euro.
- 4.5 TDA S.r.l. se réserve le droit d'étudier la faisabilité de produits "sur mesure" sur demande spécifique que du Client, d'établir un devis, les modalités et les conditions de livraison.
- 4.6 Aucune annulation de commande de produits spéciaux ou sur mesure réalisés à la demande du Client ne pourra être acceptée.
5. GARANTIE ET CONFORMITE DES PRODUITS
- 5.1 TDA S.r.l. garantit ses propres produits pour une période de 24 mois à compter de la date d'achat, selon les dispositions du Code Civil et des directives Européennes en la matière. La garantie couvre exclusivement les vices et défauts de fabrication ou d'assemblage. Les défauts d'ordre esthétique ou structurel doivent être communiqués par écrit à TDA S.r.l. seulement et exclusivement avant l'installation, en y alléguant les documents d'achat et de produit.
- 5.2 La garantie engage TDA S.r.l. seulement à la réparation et/ou au remplacement des éléments défectueux: sont cependant exclues les prétentions supplémentaires de la part de l'acquéreur, et exclus toute demande d'indemnisation dérivant de la gêne occasionnée, ou charge ou coût accessoire relatif. La garantie ne couvre pas les frais de main-d'oeuvre et ceux résultant des opérations suivantes : démontage, remontage, transport sur site, etc....
- 5.3 La non conformité devra être identifiée et confirmée uniquement par du personnel autorisé par TDA S.r.l. .
- 5.3 Sont cependant exclus de la garantie les cas suivants:
- si le défaut est dû au transport;
  - casse des parties en verre trempé;
  - si l'installation n'a pas été effectuée scrupuleusement selon les instructions de TDA S.r.l. ;
  - si le vice de fonctionnement résulte d'une intervention sur le produit effectuée sans autorisation;
  - si le fonctionnement défectueux provient de l'usure normale du produit, d'une négligence ou d'un défaut d'entretien de la part de l'acheteur eu égard aux indications alléguées au produit;
  - si le défaut résulte de l'utilisation de détergents abrasifs, à base acide, ou de produits non adaptés à l'entretien de surfaces laquées, vernies, anodisées ou vitrées. Est conseillée l'utilisation des produits d'entretien de marque « TDA S.r.l » ;
  - si le fonctionnement défectueux résulte de la force majeure;
  - altération, modification du produit du fait de l'acquéreur.
- 5.4 TDA S.r.l. décline toute responsabilité pour d'éventuels dommages causés à des personnes, des animaux ou des objets et dus à des erreurs d'installation, de réglage, à une utilisation inappropriée ou à la carence d'observation des prescriptions indiquées dans la documentation alléguée au produit.
- 5.5 TDA S.r.l. se réserve le droit d'apporter des modifications techniques et esthétiques à ses propres produits à tout moment et sans préavis, y compris les changements dans le volume et les poids.
6. LIVRAISONS ET RETOURS
- 6.1 Il incombe au destinataire de vérifier l'état des marchandises à l'arrivée, en présence du livreur. Le destinataire doit, par conséquent, ouvrir et vérifier la marchandise à la livraison devant le transporteur.
- 6.2 En cas de casse ou d'avarie, le destinataire doit impérativement le noter sur le récépissé de transport et sur le bon de livraison, et refuser le ou les colis cassés ou abîmés. En cas de colis manquant, le destinataire doit l'indiquer sur le récépissé de transport et sur le bon de livraison.
- 6.3 En France, l'Article 105 du Code du Commerce stipule que les réserves portées sur le récépissé de transport et sur le bon de livraison doivent être suffisamment claires, précises et explicites. En Belgique, ce même principe est applicable. Exemple de réserves admises « refusé car colis cassé », « refusé car produit abîmé », « manque 1 colis ». Attention, la mention « sous réserve de déballeage » ne pourra en aucun cas être prise en compte en cas de litige car elle n'est pas admise par les tribunaux. Toujours selon l'Article 105 du Code du Commerce en France, une confirmation des réserves par Lettre Recommandée avec Accusé de Réception doit être expédiée au transporteur dans les 48 heures suivant la réception de la marchandise et une copie doit nous en être adressée. Pour la Belgique, le client doit se conformer à la même procédure.
- 6.4 En l'absence de réserves expressément prévues sur le récépissé de transport et sur le bon de livraison, notre responsabilité ne pourra en aucun cas être engagée et toute réclamation ne pourra être prise en compte et donner lieu à une substitution gratuite de l'Article.
- 6.5 Les commandes sont sujettes à acceptation de TDA S.r.l. Aucune commande ne pourra être annulée ou modifiée sans le consentement de TDA S.r.l., qui se réserve le droit de facturer les éventuels frais inhérents. La confirmation de l'acceptation de modifications ou annulations et la facturation d'éventuels frais supplémentaires, sera confirmée par TDA S.r.l. uniquement par écrit. En cas d'acceptation écrite par TDA S.r.l. de retour de marchandises, le client-expéditeur devra mettre à disposition et correctement emballé pour le transport, le matériel autorisé en retour

	à la date de retrait indiquée sur l'autorisation de retour. Dans le cas contraire, TDA S.r.l se réserve le droit de facturer au client-expéditeur les coûts engendrés par la présentation du transporteur.	12.3	L'Acheteur peut exercer un droit d'utilisation des marques, noms ou autre signe distinctif ainsi que tout autre droit de propriété industrielle, intellectuelle et commerciale exclusivement réservé à TDA S.r.l., dans les limites liées au seul cadre d'utilisation et de revente des Produits à ses clients. Tout autre utilisation faite par l'Acheteur de la propriété intellectuelle de TDA S.r.l., sauf dérogation écrite et expresse de TDA S.r.l., sera considérée comme une violation des droits sus-cités exclusifs de TDA S.r.l. de la part de l'Acheteur, y compris d'un point de vue de la responsabilité contractuelle, et sera poursuivie comme telle.
	<b>7. CONDITIONS D'EXPEDITION DES PRODUITS</b>		
7.1	Les délais de production et/ou d'expédition des Produits indiqués sur la confirmation de commande ne sont donnés qu'à titre purement indicatif.		
7.2	Leur dépassement ne saurait entraîner des indemnités de retard ou dommages et intérêts. Il ne pourrait en outre constituer un motif d'annulation, qu'en cas de retard supérieur à 6 semaines non justifié par une circonstance indépendante de la volonté de TDA S.r.l. (notamment force majeure, événement imprévu, guerre, acte de terrorisme, incendie, grève, accident, retards dus aux fournisseurs de la société ou aux transporteurs, commande incomplètement ou non correctement renseignée par l'Acheteur).	13.	<b>INFORMATION PREALABLE</b>
7.3	Dans l'hypothèse où le retard dépasse 6 semaines, l'Acheteur a la faculté d'annuler la commande en informant TDA S.r.l. par écrit (fax) en respectant un préavis de 10 jours.	13.1	<b>Définition</b> Le règlementation (UE) n ° 679/2016 dispose que l'intéressé doit être préalablement informé de l'utilisation des données le concernant et que le traitement des données à caractère personnel n'est autorisé qu'avec le consentement exprès du sujet concerné, sauf dans les cas prévus par la loi.
7.4	Dans tous les cas, l'éventuelle prise en charge pour dommages subis suite à un retard de livraison imputable à TDA S.r.l., ne pourra être supérieure à un montant correspondant à 5% du prix net des Produits livrés en retard.	13.2	<b>Responsable du traitement</b> Le responsable du traitement des données est TDA S.r.l., via Circonvallazione, 1 – 25020, San Gervasio Bresciano (BS) – Italia, Tel. 030 9926311, Fax 030 9926312, Mail info@tda.it
7.5	Le paiement des sommes indiquées au point 7.4. annule toute autre demande de dédommagement pour retard de livraison.	13.3	<b>Finalités du traitement</b> Les données personnelles sont traitées dans le cadre de l'activité normale de la société TDA S.r.l. à des fins liées à: . Accomplissement des obligations fiscales ou comptables . Gestion des clients (administration des clients, administration des contrats, commandes et factures, gestion des réservations) . Gestion des fournisseurs (administration des fournisseurs, administration des contrats, commandes, factures, sélection en fonction des besoins de l'entreprise) . Préparation des devis, gestion et exécution des contrats Destinataires ou catégories de destinataires auxquels des données personnelles peuvent être communiquées Les données peuvent être transmises à des sociétés externes ou à des personnes exerçant des activités strictement liées et instrumentales à la gestion de la relation commerciale, telles que: . établissements de crédit et sociétés de transactions financières . consultants et indépendants, individuels ou en association
	<b>8. RECLAMATIONS</b>		
8.1	Les échéances de paiement ne peuvent être suspendues, retardées ou compensées par l'Acheteur sous aucun prétexte, même en cas de litige, réclamation et/ou contestation en cours, sous peine notamment de suspension de toutes les commandes en cours par TDA S.r.l.		
	<b>9. JURIDICTION COMPETENTE</b>		
9.1	Les contrats entre TDA S.r.l. et l'Acheteur sont dirigés par la loi italienne, avec exclusion de ce que prévu par la Convention de Vienne de 1980 sur la vente internationale de marchandises.	13.4	<b>Période de conservation</b> Les données personnelles seront conservées pour une durée maximale de 10 ans à compter de la dernière facturation et / ou jusqu'à la conclusion de la relation contractuelle et au-delà uniquement pour l'exécution des obligations fiscales et comptables
9.2	Sera seul compétent en cas de litige de toute nature ou de contestation relative notamment à la formation ou l'exécution de la commande, le Tribunal de Commerce dont relève le siège social de TDA S.r.l., à moins que celle-ci ne préfère saisir toute autre juridiction compétente.		
9.3	Toutefois, en dérogation à ce qui est mentionné ci-dessus, TDA S.r.l. se réserve la faculté de porter la contestation devant le Tribunal de compétence du siège social du client.	13.5	<b>Droits des personnes concernées</b> L'intéressé a le droit d'obtenir du responsable du traitement la confirmation qu'il traite ou non des données personnelles le concernant et, dans ce cas, a le droit de: . obtenir l'accès aux données personnelles, demander la rectification, l'annulation, la limitation ou s'opposer à leur traitement; . recevoir, sous une forme structurée lisible par machine, de manière commune et automatique, les données personnelles le concernant et transmettre ces données à un autre contrôleur de données (portabilité des données); . être informé de l'existence d'un processus automatisé de prise de décision, y compris le profilage; . révoquer le consentement à tout moment, sans préjudice de la légalité du traitement basé sur le consentement donné avant la révocation; . proposer une plainte à l'Autorité de surveillance
	<b>10. ECOTAXE RAEE</b>		
10.1	Les prix indiqués par TDA s'entendent hors ECOTAXE RAEE.	13.6	<b>Nature des données et conséquences de la non-communication</b> Sans le traitement et la communication des données à caractère obligatoire aux fins décrites, les services et / ou produits demandés, en tout ou en partie, ne peuvent être fournis à l'intéressé.
	<b>11. FORCE MAJEURE</b>		
11.1	Chaque partie pourra suspendre l'exécution de ses obligations contractuelles si celle-ci est rendue impossible ou anormalement onéreuse par un événement imprévu indépendant de sa volonté, notamment: grève, Boycot, incendie, acte de terrorisme, guerre (déclarée ou pas), guerre civile, révoltes et révolutions, réquisitions, embargo, interruption de la distribution énergétique, accidents, retards dus aux Fournisseurs ou aux transporteurs.		
11.2	La partie qui souhaiterait faire jouer cette clause devra communiquer par écrit à l'autre partie le début et la fin des circonstances de force majeure.		
11.3	Dans le cas où la suspension pour force majeure dure plus de 6 semaines, chacune des parties aura le droit de mettre un terme au contrat par écrit en respectant un préavis de 10 jours.	13.7	
	<b>12. PROPRIETE INDUSTRIELLE ET INTELLECTUELLE</b>		
12.1	L'Acheteur reconnaît que les documents, dessins, marques, noms, données et informations délivrées par TDA S.r.l. (imprimés sur papier ou en version électronique) sont la propriété exclusive de TDA S.r.l. et ne peuvent en aucune manière être divulgués, altérés, modifiés, effacés en totalité ou en partie.		
12.2	L'Acheteur s'engage à ne pas les reproduire ni les divulguer à des tiers et en limiter l'usage à la stricte utilisation du Produit acheté.		

## DE Allgemeine Verkaufsbedingungen

Preise ZZGL. MWST  
Maßangaben in cm

1. GÜLTIGKEIT UND ÄNDERUNGSRECHT  
Jeder Vertrag, der von TDA Srl zum Verkauf der in der Preisliste genannten Produkte an jeden Kunden (genannt der „Käufer“) unterzeichnet wird, unterliegt den Allgemeinen Verkaufsbedingungen.
- 1.1 Falls keine Übereinstimmung zwischen den hier genannten Verkaufsbedingungen und eventuellen Sondervereinbarungen zwischen TDA Srl und dem Käufer gegeben ist, gelten die Sondervereinbarungen.
- 1.2 behält sich das Recht auf Modifikationen und/oder Änderungen der Allgemeinen Verkaufsbedingungen, sowie der Preisliste vor.
2. EIGENSCHAFTEN DER PRODUKTE
- 2.1 Eventuelle Hinweise zu den Produkten und ihrer Verwendung in den von TDA Srl abgeschlossenen Verkaufsverträgen gelten für die Parteien als bindend, es sei denn, sie treffen in dem jeweiligen Kaufvertrag gesonderte Vereinbarungen.
- 2.2 Eventuelle Informationen oder Angaben über Merkmale und/oder technische Eigenschaften der Produkte in der Preisliste haben lediglich Hinweischarakter und sind nicht verbindlich. Die Produkte werden aus verschiedenen Materialien hergestellt: TDA Srl behält sich das Recht vor, Änderungen vorzunehmen, die als notwendig und/oder angemessen angesehen werden, ohne dabei die grundsätzlichen Eigenschaften bzw. die Verpackung der Produkte zu ändern.
3. PREIS UND ZAHLUNGSFRISTEN
- 3.1 Falls schriftlich keine spezifische Sondervereinbarung zwischen TDA Srl und dem Käufer bezüglich des Produktpreises vorliegt, gilt für jedes Produkt der jeweils zum Zeitpunkt des Vertragsabschlusses gültige Listenpreis.
- 3.2 Wenn der Käufer das Produkt nicht innerhalb der vereinbarten Zahlungsfrist bezahlt, kann TDA Srl nach eigenem Ermessen und ohne vorherige Benachrichtigung die laufenden Produktlieferungen unterbrechen und/oder weitere Lieferungen stornieren. Nach erfolgter Zahlung werden die Lieferfristen der offen gebliebenen Bestellungen gemäß den in der Preisliste genannten Produktionszeiten neu berechnet. Die Bezahlung bereits gelieferter Produkte ist nicht der vollständigen Durchführung des Auftrags unterworfen.
- 3.3 Ohne Ausschluss sonstiger Rechtsbehelfe gemäß dem Gesetz und den vorliegenden Allgemeinen Verkaufsbedingungen und unbeschadet des Anspruchs auf Schadenersatz behält sich TDA Srl das Recht vor, Verzugszinsen auf verspätete Zahlungen zu erheben. Diese werden, gemäß der geltenden EU-Bestimmung 2000/35, ohne Notwendigkeit einer formellen Inverzugsetzung ab dem Datum des erworbenen Zahlungsanspruchs berechnet.
- 3.4 Der vereinbarte Preis bleibt, sofern nicht anderweitig festgelegt, bis zu dem in der Auftragsbestätigung genannten Lieferdatum unverändert. Falls das Lieferdatum sich auf Anfrage des Käufers oder aus nicht von TDA Srl verschuldeten Gründen verzögert, behält sich TDA Srl das Recht auf eine Preisänderung vor, indem sie dem Käufer eventuelle Erhöhungen und/oder Zwischenlagerungskosten anrechnet.
4. AUFTRAGSANNAHME
- 4.1 Die Aufträge gelten nur dann als gültig, wenn sie in schriftlicher Form erfolgen und bei TDA Srl per Fax oder E-Mail an die entsprechend mitgeteilten Adressen eingehen.
- 4.2 Solange die Bestellung eines Käufers nicht in schriftlicher Form von TDA Srl bestätigt und von jenem zur Kenntnis genommen wurde, wird zwischen TDA Srl und dem Käufer kein Vertrag abgeschlossen.
- 4.3 Die Bestellungen und/oder Bestellungsänderungen müssen vom Käufer schriftlich per Fax oder E-Mail mitgeteilt/bestätigt werden.
- 4.4 Bei einer Bestellung unter € 250,00 (ohne MwSt), wird eine Bearbeitungsgebühr von € 10,00 (ohne MwSt) erhoben.
- 4.5 TDA Srl behält sich das Recht vor, die Realisierbarkeit von Produkten auf spezifische Anfrage des Kunden hin zu prüfen und die auf spezifische Anfrage des Kunden hin zu prüfen und die entsprechenden Preise, sowie Lieferbedingungen und -fristen festzulegen.
5. KONFORMITÄTSGARANTIE DER PRODUKTE
- 5.1 TDA Srl garantiert für ihre Produkte 24 Monate ab Lieferung und gemäß DPR 224 24/05/1988 (Italien) im Rahmen der europäischen Richtlinien. Die Garantie deckt insbesondere Fabrikationsfehler und Materialdefekte ab. Ästhetische oder funktionale Defekte müssen vor Installation schriftlich direkt an TDA Srl mitgeteilt werden, unter Beilage der Lieferdokumente und Produktdokumente.
- 5.2 TDA Srl Garantie gilt ausschließlich für die Reparatur oder den Ersatz der defekten Elemente: andere Forderungen oder Reklamationen der Erwerber werden nicht anerkannt, daraus abgeleitete Unannehmlichkeiten, Belastungen oder Nebenkosten werden ausdrücklich abgelehnt. Die Übereinstimmung der Reklamation muss durch autorisiertes Personal von TDA Srl bestätigt werden.
- 5.3 Die TDA Srl Garantie erlischt automatisch in folgenden Fällen
- im Falle von Transportschäden;
  - bei Bruch von ESG-Teilen;
  - wenn die Montage nicht gemäß den Anleitungen von TDA Srl vorgenommen wurde;
  - bei Auftreten eines technischen Defekts auf Grund von unbefugten technischen Veränderungen am Produkt;
  - im Falle von üblichen Verschleißerscheinungen, sowie bei unsachgemäßer und unvorsichtiger Behandlung des Produkts durch den Benutzer;
  - bei Verwendung von säurehaltigen oder aggressiven Reinigungsmitteln oder Waschsubstanzen, die für Glas, eloxierte, lackierte oder verschönerte Oberflächen nicht geeignet sind. Die Verwendung von TDA Srl-Reinigungsprodukten wird empfohlen;
  - Defekte, die durch höhere Gewalt entstehen;
  - wenn das Produkt durch den Erwerber nicht bezahlt wurde;
- 5.4 TDA Srl lehnt jegliche Verantwortung für mögliche Personen- oder Sachschäden ab, die auf Grund von Installations- oder Montagefehlern, unsachgemäßen Gebrauch oder mangelhafte Wartung entstehen.
- 5.5 TDA Srl behält sich vor, jederzeit ohne jegliche Vorankündigung technische oder design Änderungen an den eigenen Produkten vorzunehmen, einschließlich der Änderungen in Volumen und Gewicht.
6. VERSAND UND RÜCKGABE VON PRODUKTEN
- 6.1 Der Empfänger ist verpflichtet, die Ware bei Eingang zu überprüfen und eventuelle Schäden sofort und direkt bei dem Frachtführer zu beanstanden, der hierfür verantwortlich ist. Es ist Recht des Empfängers und Pflicht des Frachtführers den Versand (ohne die Verpackung zu öffnen) zu kontrollieren und den eventuellen Vorbehalt im Frachtführer und TDA Srl Lieferschein daneben zu stellen: allein die allgemeine Aufschrift: „Kontrollvorbehalt“ gilt nicht.
- 6.2 Verdeckte Schäden: im Fall von äußerlich beschädigten Verpackungen, können diese entgegengenommen werden, wobei auf dem Lieferschein der Vermerk „KONTROLLVORBEHALT“ und die Begründung des Vorbehalts vermerkt werden muß, wie vom geltenden Gesetz vorgesehen. Bei eindeutigen ermittelten Bruchschäden muss der Empfänger durch Einschreibebrief an TDA Srl und, zur Kenntnisnahme, dem Frachtführer die entsprechende Mitteilung machen, und ihn innerhalb von 8 Tagen nach Erhalt der Ware zusenden.
- 6.3 Sichtbarer Schaden: Im Fall von deutlich, feststellbarem Schaden muss auch Seitens des Frachtführers ein Vorbehalt im Lieferschein vermerkt werden, in der die Menge, die beschädigten Teile, sowie innere oder äußere Schäden klar zu bezeichnen sind. Kopien des Lieferscheins müssen an TDA Srl geschickt werden, das darauf hin die geeigneten Maßnahmen für den eventuellen Ersatz oder Warenrücksendung treffen wird.
- 6.4 Bei Nichtbeachtung der Paragraphen 6.2 und 6.3 erkennt TDA Srl keine Erstattung für Schäden an.
- 6.5 Kein Artikel wird ohne das schriftliche Einverständnis von TDA Srl zurückgenommen: genehmigte Rücknahmen müssen unserem Werk frachtfrei mit der Angabe des Frachtführers und der von TDA Srl mitgeteilten Bezugsnummer zugehen. Die Bezugsnummer soll im Lieferschein vermerkt werden. Für Annahme und Bearbeitung von Rücksendungen werden generell Rücksendungskosten in Rechnung gestellt, die sich nach dem Zustand der zurück gesendeten Ware richten.



	7. LIEFERFRISTEN DER PRODUKTE	Alleinrechte von TDA Srl durch den Käufer, auch in Bezug auf die Vertragshaftung, und wird entsprechend rechtlich verfolgt.
7.1	Der Liefertermin für die Produkte, der auf der Auftragsbestätigung genannt wird, hat stets Hinweiskarakter und ist nicht als verbindlich anzusehen. sofern nicht anderweitig schriftlich vereinbart.	
7.2	Falls TDA Srl die Produkte nicht innerhalb der vereinbarten Lieferfrist zustellen kann, informiert sie den Käufer darüber, sofern möglich, mit Angabe des vorgesehenen neuen Liefertermins. Wenn die von TDA Srl verschuldete Verspätung mehr als 6 Wochen beträgt, kann der Käufer den Vertrag über die verspäteten Produkte mit 10-tägiger schriftlicher Vorankündigung per Fax an TDA Srl auflösen, unter Ausschluss aller sonstigen Rechtsbehelfe oder Schadenersatzansprüche.	13. DATENSCHUTZERKLÄRUNG 13.1 Definition Die Verordnung (EU) Nr. 679/2016 legt fest, daß der Betroffene im Voraus über die Verwendung der ihn betreffenden Daten informiert werden muss und daß die Verarbeitung personenbezogener Daten nur mit ausdrücklicher Zustimmung des Betroffenen gestattet wird, abgesehen von gesetzlich vorgesehenen Ausnahmefällen
7.3	Eventuelle Verspätungen, die durch höhere Gewalt oder Zufälle bzw. bestimmte Handlungen oder Nachlässigkeiten des Kunden begründet sind (z.B. fehlende Angabe notwendiger Hinweise für die Lieferung der Produkte), können nicht TDA Srl zugeschrieben werden.	13.2 Auftragsverarbeiter der Daten Der Auftragsverarbeiter der Daten ist TDA S.r.l., via Circonvallazione, 1 – 25020, San Gervasio Bresciano (BS) – Italia, Tel. 030 9926311, Fax 030 9926312, Mail info@tda.it
7.4	Wenn TDA Srl durch nicht selbstverschuldete Gründe vorübergehend oder dauerhaft nicht lieferfähig ist, wird sie den Käufer darüber informieren und ist für die gesamte Dauer der Behinderung, sowie der daraus entstehenden Folgewirkungen von sämtlichen Lieferpflichten befreit, ebenso wie von der Schadenersatzpflicht gegenüber dem Käufer aufgrund von Verspätung oder Nichterfüllung.	13.3 Zweckbestimmung der Datenverarbeitung Personenbezogene Daten werden im Rahmen der normalen Tätigkeit der Firma TDA S.r.l verarbeitet. zu folgenden Zwecken: . Die Erfüllung der Steuer- oder Rechnungslegungspflichten . Kundenmanagement (Kundenverwaltung, Vertragsverwaltung, Bestellungen, Rechnungen,Auswahl im Bezug auf den Unternehmen sbedarf) . Lieferantenmanagement (Lieferantenverwaltung, Vertragsverwaltung, Bestellungen, Rechnungen,Auswahl im Bezug auf den Unternehmensbe darf) . Erstellung von Kostenvorschlägen, Verwaltung und Erfüllung von Verträgen
8.1	Es wird vereinbart, dass der Käufer bei eventuellen Reklamationen oder Beanstandungen, die einen Teil der gelieferten Ware oder eine einzelne Warenlieferung betreffen, keinesfalls berechtigt ist, die beanstandeten Produkte nicht bzw. verspätet zu zahlen. ebenso wenig wie eventuelle weiteren Lieferungen.	13.4 Empfänger oder Kategorien von Empfängern, denen die Daten mitgeteilt werden dürfen Die Daten dürfen an externen Gesellschaften oder Personen mitgeteilt werden, die verbundene Tätigkeiten und Dienstleistungen für das Management der Geschäftsbeziehung entfalten, wie zum Beispiel: . Kreditinstitute oder Finanzdienstleister . Berater und Freie Berufe, allein oder gemeinschaftlich betreiben
	9. GERICHTSSTAND	
9.1	Die Verträge zwischen TDA Srl und dem Käufer basieren auf italienischem Recht, mit Ausnahme der Vereinbarung der Wiener-Konvention von 1980 über den internationalen Warenverkehr.	
9.2	In Abweichung von der obigen Bestimmung hat TDA Srl jedoch in jedem Fall die Möglichkeit, einen Streitfall auch vor das am Sitz des Käufers zuständige Gericht zu bringen.	13.5 Speicherungsfrist Personenbezogene Daten werden für maximal 10 Jahre ab der letzten Rechnungsstellung und /oder bis zum Ende des Vertragsverhältnisses; und darüber hinaus nur für die Erfüllung der Steuer- oder Rechnungslegungspflichten
	10. ÖKOGEBÜHR ERP	
10.1	Die Preise verstehen sich zzgl. der Ökogeühr für ERP	
	11. HÖHERE GEWALT	
11.1	Jede Partei kann die Durchführung ihrer Vertragspflichten vorläufig unterbrechen, sofern diese durch unvorhergesehene und nicht durch sie beeinflussbare Ereignisse unmöglich oder unnötig erschwert wird, dazu gehören z.B. Streik, Boykott, Aussperrung, Brand, Krieg (mit oder ohne Kriegserklärung), Bürgerkrieg, Erhebungen und Aufstände, Beschlagnahme, Embargo, Energieausfälle oder eine verspätete Lieferung von Teilen oder Rohstoffen.	13.6 Rechte des Betroffenen Die betroffene Person hat das Recht, von dem Datenverarbeiter eine Bestätigung zu erhalten, ob betreffende Daten verarbeitet werden oder nicht, in diesem Fall hat die betroffene Person die folgenden Rechte: . Auskunft über personenbezogene Daten zu erlangen, Berichtigung, Löschung, Einschränkung, oder einer solchen Verarbeitung zu widersprechen; . die personenbezogenen Daten in einem strukturierten, gängigen, maschinenlesbaren und interoperablen Format zu erhalten und sie einem anderen Auftragsverarbeiter zu übermitteln (Datenübertragbarkeit); . von der Existenz eines automatisierten Entscheidungsprozesses, einschließlich der Profilierung informiert werden; . die Einwilligung jederzeit zu widerrufen, ohne dass die Rechtmäßigkeit der aufgrund der Einwilligung bis zum Widerruf erfolgten Verarbeitung berührt wird; . bei der Aufsichtsbehörde Beschwerde einzulegen
11.2	Falls eine Partei von dieser Klausel Gebrauch machen möchte, muss sie die andere umgehend schriftlich über das Eintreten, sowie das Ende der Umstände höherer Gewalt informieren.	
11.3	Falls die oben genannte Unterbrechung aufgrund höherer Gewalt länger als 6 Wochen andauert, hat jede Partei das Recht, mit einer schriftlichen Vorankündigung von 10 Tagen an die andere Partei vom Vertrag zurückzutreten.	
	12. GEWERBLICHES UND GEISTIGES EIGENTUM	
12.1	Der Käufer erkennt an, dass sämtliche Unterlagen, Zeichnungen, Marken, Namen, Daten und Informationen (sowohl in gedruckter, als auch elektronischer Form) ausschließliches Eigentum von TDA sind und in keiner Weise verbreitet, verändert, modifiziert, entfernt oder gelöscht werden können.	13.7 Art der betroffenen Daten und Folgen der Nichtübermittlung Ohne die Verarbeitung und Mitteilung von Pflichtdaten für die genannten Zwecken, dürfen der betroffenen Person die angeforderten Dienstleistungen und / oder Produkte, ganz oder teilweise, nicht zur Verfügung gestellt werden
12.2	Der Käufer verpflichtet sich, diese nicht zu vervielfältigen oder an Dritte weiterzugeben und ihre Verwendung speziell auf das erworbene Produkt zu beschränken.	
12.3	Der Käufer hat ein eingeschränktes Recht zur Nutzung von Marken, Namen oder anderen Erkennungszeichen sowie sonstiger industrieller Patentrechte bzw. Produktions- und Geschäfts-Know-How in Bezug auf die Ware, die ausschließliches Eigentum von TDA Srl darstellen, mit dem einzigen Zweck der Verwendung oder des öffentlichen Verkaufes der Waren. Jede hiervon abweichende Nutzung des geistigen Eigentums von TDA Srl durch den Käufer gilt, sofern keine ausdrückliche schriftliche Genehmigung von TDA Srl vorliegt, als Verletzung der oben genannten	

TDA si riserva, a proprio insindacabile giudizio, di apportare modifiche anche senza preavviso, allo scopo di migliorare la produzione.

TDA reserves the right to modify the products without advance notice to improve the production

TDA se réserve le droit, à sa seule discrétion, d'apporter des modifications sans préavis afin d'améliorer la production

TDA vorbehaltet sich das Recht, ohne Voranmeldung, wesentliche Änderungen für eine Verbesserung der Produktion einzuführen

**TDA srl**  
**via Circonvallazione, 1**  
**I-25020 San Gervasio Bresciano (BS)**  
**tel. +39 030 9926311**  
**fax +39 030 9926312**  
**www.tda.it**  
**info@tda.it**

**TDA United Kingdom**  
**tel. +39 030 9926340**  
**fax +39 030 9926312**  
**www.tda.it**  
**sales@tda.it**

**TDA France**  
**tel. +33 04 72 28 04 98**  
**fax +33 04 72 28 04 99**  
**www.tdafrance.fr**  
**info@tdafrance.fr**

**TDA Deutschland**  
**tel. +49 (0)37323 573 599**  
**fax +39 030 9926312**  
**www.tda.it**  
**verkauf@tda.it**